



Telemotive[®] TR24 *inteleSmart*[™] Receiver

Radio Control Equipment

Instruction Manual



MAGNETEK
MATERIAL HANDLING
TELEMOTIVE

TCTR24-0 Rev. L September 2014
Part Number: 30035T
©Copyright 2014 Magnetek Material Handling

Table of Contents

- 1- **Service Information1**
- 2- **Radio Controlled Crane Safety..... 2-10**
- 3- **General System Information..... 11-12**
- 4- **Installation Procedure 13-17**
- 5- **Operation..... See Appropriate Transmitter Manual**
- 6- **Wiring 19-48**
- 7- **Programming..... 49-67**
- 8- **RCP Programming 68-76**
- 9- **Servicing..... 77-80**
- 10- **Spare Parts81**

Section 1 – Service Information

1-1. Service Information.

Your New Radio Remote

Thank you for your purchase of the Magnetek's Telemotive® Brand TR24 *inteleSmart* Receiver. Magnetek has set a whole new standard in performance, dependability, and value with its unique new line of receivers. Without a doubt, our Telemotive TR24 is the ultimate solution for having precise, undeterred, and safe control of your material.

If your product ever needs modification or service, please contact one of our representatives at the following locations:

U.S. Service Information

For questions regarding service or technical information, contact:

1-866-MAG-SERV
(1-866-624-7378).

Magnetek Material Handling
N49 W13650 Campbell Drive
Menomonee Falls, WI 53051

Telephone: 800-288-8178

Website: www.magnetek.com

e-mail: MHCustomerService@magnetek.com

Fax Numbers

Main: 800-298-3503

Sales: 262-783-3510

Service: 262-783-3508

Canada Service Information:

4090B Sladeview Crescent

Mississauga, Ontario

L5L 5Y5 Canada

Phone: 1-800-792-7253

Fax: 1-905-828-5707

Section 2 – Radio Controlled Safety

Warnings, Cautions And Notes.

Throughout this document WARNING, CAUTION and NOTE statements have been deliberately placed to highlight items critical to the protection of personnel and equipment.

WARNING – A warning highlights an essential operating or maintenance procedure, practice, etc. which if not strictly observed, could result in injury or death of personnel, or long term physical hazards. Warnings are highlighted as shown below:



CAUTION – A caution highlights an essential operating or maintenance procedure, practice, etc. which if not strictly observed, could result in damage to, or destruction of equipment, or loss of functional effectiveness. Cautions are highlighted as shown below:



NOTE – A note highlights an essential operating or maintenance procedure, condition or statement. Notes are shown as below:

NOTE

WARNINGS, CAUTIONS AND NOTES SHOULD NEVER BE DISREGARDED.

The safety rules in this section are not intended to replace any rules or regulations of any applicable local, state, or federal governing organizations. Always follow your local lockout and tagout procedure when maintaining any radio equipment. The following information is intended to be used in conjunction with other rules or regulations already in existence. It is important to read all of the safety information contained in this section before installing or operating the Radio Control System.

Section 2 – Radio Controlled Safety (continued)

2-1. Critical Installation Considerations.



WARNING

ALL EQUIPMENT MUST HAVE A MAINLINE CONTACTOR INSTALLED AND ALL TRACKED CRANES AND SIMILAR EQUIPMENT MUST HAVE A BRAKE INSTALLED. FAILURE TO FOLLOW THIS WARNING COULD RESULT IN SERIOUS INJURY OR DEATH AND DAMAGE TO EQUIPMENT.



WARNING

ON ALL REMOTE CONTROLLED CRANES AN AUDIBLE AND/OR VISUAL WARNING MEANS MUST BE PROVIDED. THESE AUDIBLE AND/OR VISUAL WARNING DEVICES MUST MEET ALL GOVERNMENTAL REQUIREMENTS. FAILURE TO FOLLOW THIS WARNING COULD RESULT IN SERIOUS INJURY OR DEATH AND DAMAGE TO EQUIPMENT.



WARNING

PLEASE FOLLOW YOUR LOCAL LOCKOUT TAGOUT PROCEDURE BEFORE MAINTAINING ANY REMOTE CONTROL EQUIPMENT. ALWAYS REMOVE ALL ELECTRICAL POWER FROM THE CRANE OR MACHINERY BEFORE ATTEMPTING ANY INSTALLATION PROCEDURES. DE-ENERGIZE AND TAGOUT ALL SOURCES OF ELECTRICAL POWER BEFORE TOUCH TESTING ANY EQUIPMENT. FAILURE TO FOLLOW THIS WARNING COULD RESULT IN SERIOUS INJURY OR DEATH AND DAMAGE TO EQUIPMENT.



WARNING

THE DIRECT OUTPUTS OF THIS PRODUCT ARE NOT DESIGNED TO INTERFACE DIRECTLY TO TWO STATE SAFETY CRITICAL MAINTAINED FUNCTIONS, I.E., MAGNETS, VACUUM LIFTS, PUMPS, EMERGENCY EQUIPMENT, ETC. A MECHANICALLY LOCKING INTERMEDIATE RELAY SYSTEM WITH SEPARATE POWER CONSIDERATIONS MUST BE PROVIDED. FAILURE TO FOLLOW THIS WARNING COULD RESULT IN SERIOUS INJURY OR DEATH AND DAMAGE TO EQUIPMENT.

Section 2 – Radio Controlled Safety (Continued)

2-2. General.

Radio controlled overhead cranes and other material handling equipment operate in several directions. They are large, bulky pieces of equipment that handle heavy loads efficiently at high speeds. Quite frequently, the equipment is operated in areas where people are working on the floor below. The crane operator must exercise extreme caution at all times. Workers must constantly be alert to avoid accidents. The following rules have been included to indicate how your careful and thoughtful actions may prevent injuries, damage to equipment, or even save a life. If radio controlled material-handling equipment is operated from the cab, special care must be taken to secure the transmitter. Refer to section titled Section 2-7.3. **Boarding The Crane** for specific safety rules.

2-3. Persons Authorized To Operate Radio Controlled Cranes.

Only properly trained persons designated by management should be permitted to operate radio-controlled cranes.

Radio controlled cranes should not be operated by any person who cannot read or understand signs, notices and operating instructions that pertain to the crane.

Radio controlled cranes should not be operated by any person with insufficient eyesight or hearing or by any person who may be suffering from a disorder or illness or is taking any medication that may cause loss of crane control.

2-4. Training Checklist For Crane Operators.

Anyone being trained to operate a radio-controlled crane should possess as a minimum the following knowledge and skills before operating the crane:

The operator should have knowledge of hazards pertaining to crane operation.

The operator should have knowledge of the safety rules for radio-controlled cranes.

The operator should have the ability to judge distance of moving objects.

The operator should have knowledge of the radio transmitter.

The operator should know how to properly test limit switches.

The operator should know, where authorized, instructions for plugging motions.

The operator should have knowledge of the use of crane warning lights and alarms.

The operator should have knowledge of observing crane signal lights.

The operator should be trained to avoid striking any obstructions.

The operator should have knowledge of the proper clearance of lifts or hooks before moving bridge or trolley.

The operator should have knowledge of the proper storage space for radio control transmitter when not in use.

The operator should be trained in transferring radio control transmitter to another person.

The operator should be trained how and when to report unsafe or unusual operating conditions.

The operator should be trained how to exhibit caution in approaching bridge or trolley bumpers.

The operator should know equipment capacity.

The operator should be trained in making lifts below floor level.

Section 2 – Radio Controlled Safety (continued)

The operator should be trained in making side pulls.

The operator should know how to keep himself and other people clear of lifts and to avoid "pinch" points.

The operator should know cable and hook inspection procedures.

The operator should know procedures for testing hoist, trolley, and bridge brakes.

The operator should know and follow the local lockout and tagout procedures.

2-5. Operating Area.

Aisles between equipment, stock, etc., should be free of obstructions so the crane operator can move freely. These aisles should be a minimum of three feet (one meter) wide, or meet local regulations.

Crane operators should always position themselves for the best view of the crane they are controlling. The crane should never be operated blindly. The operator should stay as close to the crane load as possible. Operators should never position themselves in a "pinch" point.

2-6. Transmitter Unit.

Transmitter switches should never be mechanically blocked ON or OFF for any crane motion. When not in use turn the transmitter OFF. A secure storage space should be provided for the transmitter unit and the transmitter unit should always be placed there when not in use. This precaution will prevent unauthorized people from operating the crane.

Spare transmitters should be stored in a secure storage space and only removed from the storage space after the current transmitter in use has been turned OFF, taken out of the service area and secured.

2-7. Operating The Crane.

2-7.1. Pre-operation Test

At the start of each work shift, or when a new operator takes control of the crane, operators shall do, as a minimum, the following steps before making lifts with any crane or hoist:

Test the upper-limit switch. Slowly raise the unloaded hook block until the limit switch trips. When checking limit switches the hoist should be centered over an area free of personnel and equipment.

Visually inspect the hook, load lines, trolley, and bridge as much as possible from the operator's station; in most instances, this will be the floor of the building.

The bridge and trolley brakes should be tested. On transmitter units equipped with two or more speeds, use the "lowest" speed when testing braking devices.

When lifting maximum loads, the crane operator should test the hoist brakes by raising the load a few inches from the floor. If the brakes do not hold, the load should immediately be lowered to the floor.

If provided, test the lower-limit switch.

Test all warning devices.

Test all direction and speed controls for both bridge and trolley travel.

Test all bridge and trolley limit switches, where provided, if operation will bring the equipment in close proximity to the limit switches.

Test the transmitter emergency stop.

Section 2 – Radio Controlled Safety (continued)

Test the hoist brake to verify there is no drift without a load.

If any crane or hoist fails any of the above tests notify the supervisor and lockout and tagout for repair.

2-7.2. General Rules For Operation.

Consult the crane manufacturer, local and governmental regulations for complete rules of operation. In general the following rules apply to remotely controlled cranes:

The limit switches should never be used as a regular stopping device. They are intended to be protective devices.

Do not make lifts in excess of the equipment rated capacity.

The bridge and trolley should be centered directly over the load when the load is raised to prevent swinging when making lifts.

A crane designed for this purpose and only with supervisor permission should make side pulls. When a lift is being made, the crane operator should not be positioned in the line of travel. The crane or hoist should be operated from a position either to the side or opposite from the direction of travel.

When raising or lowering a load, proceed slowly and make certain the load is under control. Tag lines should be used for handling unusual lengths or bulky loads. Remove slack from chains or slings gradually. Make certain all personnel are clear before making a lift.

The crane operator should keep all body parts away from the lift and should never be positioned under the lift.

Do not make a lift or move a load if anyone is in a location where they could be struck by the crane or the load.

If the crane operator is being assisted, the crane should not be moved until the assistant signals they are clear of the crane and its load.

When a load is hanging from the crane hook and the crane is being moved, the crane operator should sound all warning devices frequently.

Loads should not be carried over workers heads. If a worker is in the path of crane travel, the crane operator should stop the crane and clear the area before proceeding.

Runway stops or other cranes should never be bumped into.

When moving the crane, the crane operator should be sure that the hook block and attachments or cables will not catch on nearby equipment. Slings, chains, or cables should never be dragged along the floor.

Unless required for operator safety, gloves should not be worn when operating the transmitter unit.

All loose materials or parts should be removed from the load before starting the lift.

The crane operator should always hoist lifts high enough to clear all equipment and workers.

The crane operator should never permit anyone to ride on the load or hook except when authorized by the supervisor.

When another crane on the same runway is stationary with a load hanging, the crane operator should maintain a safe distance between the stationary crane and the one under their control.

Never leave suspended loads unattended. In an emergency, if the crane is inoperative and a load suspended, notify the supervisor immediately, barricade and post signs on the floor beneath crane and load.

Section 2 – Radio Controlled Safety (continued)

If power to the crane is removed, the crane operator should turn the transmitter unit OFF and keep it OFF until power is restored.

If the crane fails to respond properly, the crane operator should stop operation, turn the transmitter unit OFF and immediately report the condition to their supervisor.

Outdoor cranes, which are subject to movement by wind, should be securely anchored when left unattended. If the crane is equipped with bridge brakes, the parking brake should be set immediately.

2-7.3. Boarding The Crane.

The crane should not be boarded without permission of the supervisor.

The crane operator should turn off the transmitter and take it with them when boarding the crane.

If more than one person is boarding the crane, one person should be made responsible for ensuring all personnel are off the crane before the system is returned to operation.

2-8. Crane Maintenance And Repair.

Qualified personnel must maintain a regularly (i.e., such as monthly) scheduled crane inspection. During this crane inspection the functionality and safety of the crane remote control must also be tested. The inspection shall include, but not be limited to items listed in Section 1-13. Condition of The Radio Controlled Crane. Consult crane manufacturer, local and governmental regulations for recommended inspection intervals and proper inspection procedures. Problems noted during this inspection must be repaired before using the crane or the remote control.

Minor repairs include routine maintenance and repairs such as greasing, cleaning and control troubleshooting. All other repairs should be considered major. If the repair crew consists of more than one person, one person should be designated as the repair crew leader with the following responsibilities. If the repair crew consists of only one person, that person has the following responsibilities:

For minor repairs, warning signs should be placed on the floor beneath the crane or suspended from the crane. For major repairs, the floor area below the crane should be roped off.

When major repairs are to take place, all persons operating other cranes on the same or adjacent runways, if any, must be notified prior to starting repairs. Notification should include the nature of the repair, safeguards provided, and movement limitations while repairs are in progress.

When practical, radio controlled cranes which cannot be moved during repairs must be protected against being bumped by other cranes on the runway. Bumpers should be installed on the exposed side or sides of the crane under repair. They should be placed as far away as possible. The location of these bumpers should be indicated by red lights placed so that they are clearly visible to other crane operators traveling on the same runway. When it is not possible to use bumpers, red lights must be placed so they are clearly visible to other crane operators traveling on the same runway to indicate the restricted travel zone. All crane operators on the same runway must be informed of the repair effort and thoroughly instructed to what their operations are limited to and informed they will be notified when repairs are completed.

If any hazard involving the repairperson exists when there is a runway adjacent to the crane under repair, the adjacent runway should be blocked off as described above. When it is necessary to continue crane operation on the adjacent runways, warning lights must be installed and be visible to operators of cranes on those runways. All cranes should come to a complete stop prior to entering the restricted area and should proceed through this area only after receiving permission from a signal person designated for this purpose. Access of persons to and from the crane being repaired should be under control of the repair crew leader.

When boarding the crane, the transmitter should be turned OFF and the transmitter should remain with the repair crew leader. The leader should board the crane first, open and lockout the main switch, and then signal the other members of the crew it is safe to board the crane.

Section 2 – Radio Controlled Safety (continued)

If work on the crane is to be done in areas not protected by standard handrails, the repair crew should wear approved safety belts.

All tools and equipment should be moved onto the crane by the use of hand lines. The tools and equipment should be adequately secured to the hand lines.

If it is necessary to have the crane control circuits energized, all power circuits for crane movement must be opened prior to energizing the control circuits.

All personnel and tools should be moved to a safe spot before moving the crane during repairs.

Headroom is at a minimum in some crane cabs and on some crane walkways. Caution should be exercised when boarding or working on cranes. Hard hats should be worn whenever possible.

When repairs are finished, all personnel, tools and repair equipment should be removed before energizing the crane circuits.

2-9. Using The Crane As A Work Platform.

When the crane is to be used as a stationary work platform, follow all rules provided in Section 1-11. Crane Maintenance and Repair. When it is necessary for the crane to be moved from time to time, the crane operator should board the crane with the transmitter unit. The crane operator should ensure all personnel working on the crane are in a secure position before moving the crane to the next workstation. It should also be the crane operator's responsibility to ensure the main switch is open and locked down before work is resumed.



WARNING

THE CRANE OPERATOR SHOULD NOT ATTEMPT TO REPAIR ANY OF THE ITEMS STATED BELOW. THE CRANE CONDITION SHOULD BE REPORTED TO THE SUPERVISOR. FAILURE TO FOLLOW THIS WARNING COULD RESULT IN SERIOUS INJURY OR DEATH AND DAMAGE TO EQUIPMENT.

2-10. Condition Of The Radio Controlled Crane.

If the crane fails to respond properly, the crane operator(s) should notify their supervisor. When serious conditions are noticed (conditions that make the crane unsafe to operate), the crane should be shut down immediately and the supervisor notified. The following is a list of some of the items that should be included in the report (See the crane manufacturer for specifics and possible additional items):

Condition of hoisting cable and hook block (broken strands, clipped sheave wheels, etc.).

Condition of brakes (hoist, trolley, and bridge). (No bluing, rivets on shoes showing, glazing, etc.).

Condition of trolley and rail stops.

Condition of bridge structure.

Condition of festoon system.

Broken welds in any part of the crane structure.

Proper fluid levels and lubrication.

Condition of bridge and trolley stops.

Section 2 – Radio Controlled Safety (continued)

Carbon dust or signs of burning on the covers of motors.

Indication of fluid, oil or grease leaks.

Condition of rail sweeps.

Walkways require handrails and ladders are sturdy and in place, not loose.

Protective guards are in place for all moving parts.

Alignment of bridge (screeching or squealing wheels indicate bridge is out of line).

Broken, cracked, or chipped rails on trolley or runway.

Condition of limit switches.

Condition of electrical and mechanical control (electrical or mechanical defects which cause faulty operation such as uncommanded stopping or starting of any crane motions, warning devices, lights, or auxiliary functions).

Condition of gears (grinding or squealing may indicate foreign materials in gear teeth or a lack of lubrication).

All controls (especially E-STOPS) are in place and in working order.

Frequent relay tripping of power circuits.

Mechanical parts loosened by vibration (loose rivets, covers, bolts, etc.).

Uneven riding (worn or damaged wheels).

Condition of collector shoes or bars.

Condition of warning or signal lights and horns. (Burned out or broken).

2-11. Batteries



WARNING

KNOW AND FOLLOW PROPER BATTERY HANDLING, CHARGING AND DISPOSAL PROCEDURES. IMPROPER BATTERY PROCEDURES CAN CAUSE BATTERIES TO EXPLODE OR DO OTHER SERIOUS DAMAGE. FAILURE TO FOLLOW THIS WARNING COULD RESULT IN SERIOUS INJURY OR DEATH AND DAMAGE TO EQUIPMENT.

2-12. Battery Handling.

Use only batteries approved by Telemotive for the specific product.

Do not dispose of a battery pack in fire; it may explode.

Do not attempt to open the battery pack.

Do not short circuit battery.

Section 2 – Radio Controlled Safety (continued)

For intrinsically safe environments only use specified Telemotive intrinsically safe batteries.

Keep the battery pack environment cool during charging operation and storage, (i.e., not in direct sunlight or close to a heating source).

2-13. Battery Charging.

For those transmitters equipped with battery chargers, please familiarize all users with the instructions of the charger before attempting to use.

Do not attempt to charge non-rechargeable battery packs.

Avoid charging the battery pack for more than 24 hours at a time.

Do not charge batteries in a hazardous environment.

Do not short the charger.

Do not attempt to charge a damaged battery.

Do not attempt to use a battery that is leaking, swollen or corroded.

Charger units are not intended for outdoor use. Use only indoors.

2-14. Battery Disposal.

Before disposing of batteries consult local and governmental regulatory requirements for proper disposal procedure
Use only Telemotive approved chargers for the appropriate battery pack.

Section 3 – General System Information

3-1. General System Information.

The Telemotive Radio Control System (system) provides remote control of overhead cranes using radio signals. The system consists of a hand held portable battery operated transmitter unit and a fixed station receiver unit.

A unique 16-bit code (Access Code) for each system is preset in every transmitter and receiver. The receiver considers any received signal, which does not match the receiver access code setting, invalid. The Access Code is made up of 16-bits (65,000 combinations) and no two similar codes are assigned to any two Telemotive systems.

Up to four systems may be used with the same frequency in a 600-foot area (220 meters). Each transmitter operating on the same frequency may be operated in close proximity, not less than six feet (1.9 meters) to each other.

3-2. TMS Low Power Signaling.

TMS (Time Multiplexed Signaling) is a Telemotive proprietary high-speed packet data system. The system software is structured to minimize "on the air" transmission time of any transmitter. This allows for multiple transmitters to share a common frequency. The TMS system is designed so that a transmitter will send a signal for a predetermined ON time, and then will turn OFF. The length of transmitter ON time is referred to as data burst or packet. The packet length is a function of the quantity of data to be sent, and the data rate (baud). Once the packet is sent, the transmitter will turn OFF. This allows for other transmitters to time-share the same frequency when a transmitter has turned OFF. The TMS system software determines the OFF period and repetition rate of the ON period. Since each system has its own access code, up to 4 transmitters can share and have equal access to the same frequency. TMS also allows for reduced battery consumption and extended battery life.

These systems have low power pulsed signaling, FCC certified under Part 15 Telecommunications Code of Regulations, no license is required. The transmitter unit is frequency modulated, low power and is certified under the appropriate regulations. A license is not required for the transmitter or operator. Modifications to the RF section of this system are not permitted and could void FCC certification.

3-3. Channel Designations:

AK01 - 439.8 MHz	AK06 - 438.8 MHz
AK02 - 439.6 MHz	AK07 - 438.6 MHz
AK03 - 439.4 MHz	AK08 - 438.4 MHz
AK04 - 439.2 MHz	AK09 - 438.2 MHz
AK05 - 439.0 MHz	AK10 - 438.0 MHz
AK11 - 437.8 MHz	AK16 - 436.8 MHz
AK12 - 437.6 MHz	AK17 - 436.6 MHz
AK13 - 437.4 MHz	AK18 - 436.4 MHz
AK14 - 437.2 MHz	AK19 - 436.2 MHz
AK15 - 437.0 MHz	AK20 - 436.0 MHz
AKA00 - 433.125 MHz	AKA05 - 434.125 MHz
AKA01 - 433.325 MHz	AKA06 - 434.325 MHz
AKA02 - 433.525 MHz	AKA07 - 434.525 MHz
AKA03 - 433.725 MHz	AKA08 - 434.725 MHz
AKA04 - 433.925 MHz	AK38 - 432.4 MHz
AK50 - 430.0MHz	

Section 3 – General System Information (continued)

3-4. Receiver Specifications.

Receiver housing: NEMA 4X, IP67

Operating Temperature: -22° F to +158° F (-30° C to +70° C) ambient.

Humidity: up to 95 % (non-condensing).

Typical Operating Range: 300 feet (91 meters).

Relays are rated for 16 Amps 277VAC/24VDC, 1 HP 240VAC for maximum life and surge protection, they are fused with 2AG Slow Blo fuses and protected with MOV's.

3-5. Receiver Unit.

The receiver unit consists of a synthesized RF module, antenna, integral power supply, microprocessor controlled output motor control and auxiliary function relays and mainline contactor relay. The receiver unit contains circuitry, which matches the frequency and access code of the transmitter.

Section 4 – Installation

4-1. Pre-Installation Considerations.

To ensure reliable and safe operation of the system, the following items must be considered before installing the receiver unit.



WARNING

THE RECEIVER UNIT OR RELAYS ARE NOT RATED AS EXPLOSION PROOF. THE RECEIVER UNIT MUST NOT BE INSTALLED IN EXPLOSIVE ENVIRONMENTS UNLESS APPROPRIATE SECONDARY ENCLOSURE MEASURES ARE TAKEN. FAILURE TO FOLLOW THIS WARNING COULD RESULT IN SERIOUS INJURY OR DEATH AND DAMAGE TO EQUIPMENT.

4-2. Receiver Unit Mounting Location Considerations.

Ensure the mounting location is as far as possible from exposed trolley wires and sources of electromagnetic or radiated noise

The receiver cabinet is approximately 12" (30 cm) wide by 12" (30 cm) high. A depth of at least 18" (45 cm) must be provided to allow the cabinet door to open.

The mounting surface must be smooth and continuous. Mounting the cabinet on uneven surfaces could cause warpage or stress internal components.

The receiver unit may be mounted in any position. Greatest radio control range is obtained when the receiver unit is mounted with the antenna at the top.

If possible, avoid installing receiver unit to a surface where high vibration or shock is present. If this cannot be avoided, use appropriate shock mounts.

4-3. Antenna Mounting Considerations.

It is best to mount the antenna so that it is visible to the operator. Usually, this is accomplished by mounting the antenna under the crane and pointed down. You should always try to avoid power sources, motors, drives, brakes, etc. If necessary, we offer an external antenna kit.

4-4. Line Input Considerations.



WARNING

THE UNIT MUST BE WIRED TO THE CORRECT VOLTAGE, AND BE CONNECTED TO THE CORRECT TERMINAL AS REQUIRED BY THE ACTUAL LINE VOLTAGE. FAILURE FOLLOW THIS WARNING COULD RESULT IN SERIOUS INJURY OR DEATH AND DAMAGE TO EQUIPMENT.

The receiver unit has direct connect provisions for operation from 115 VAC (nominal), 60 Hz power.

For applications where the line voltage is not between 95-130 VAC or if 260 VAC or 440 VAC power is used, a step up or step down transformer must be used.

Section 4 – Installation (continued)

NOTE

THE RECEIVER UNIT SHOULD NOT BE CONNECTED TO LINES CONTAINING EXCESSIVE POWER UP TRANSIENTS OR CONTINUOUS COMMUTATOR NOISE. A LINE CONDITIONER MAY BE NECESSARY IN SOME INSTALLATIONS.

4-5. Wiring Considerations.

1. Read this manual before installation.
2. Please observe appropriate local and National Electrical Codes when wiring electrical devices.
3. Do not connect or disconnect wiring, or perform circuit checks while the power is turned on.
4. The motor wiring should be in a separate metal conduit from the power wiring, which should also be in metal conduit.
5. Low voltage wires shall be wired with proper low voltage class wiring procedures. Control wiring as well as antenna wiring shall be in separate conduit and shall be kept as short as possible.
6. All terminals shall be tightened to specified terminal torque 4.4 IN-LBS (.5 N·m). Unless otherwise specified.
7. Remove excess metal screws, metal filings and wire clippings from inside of unit.
8. Inspect to make sure no exposed wire has contact with any other wiring or terminals.
9. Suppressors are strongly recommended on all contactors.

4-6. Receiver/Equipment Interface Considerations.

Relays are rated for 16 Amps 277VAC/24VDC, 1 HP 240VAC for maximum life and surge protection, they are fused with 2AG Slow Blo fuses and protected with MOV's. Connection to equipment or contactors with higher voltage or current requirements will require intermediate relays.

All relay outputs are normally open, momentary contact. Since a relay closure is only active while the transmitter unit key is pressed and held, devices such as lights or lifting magnet must use a mechanical auxiliary latching relay.

4-7. Receiver Unit Cabinet Mounting.

See next page Figure 4-2. Receiver Mounting Details. Allow room in mounting the receiver for the door to swing open

Mount receiver unit cabinet securely to mounting surface. Actual cabinet mounting dimensions are shown on next page Figure 4-2. Receiver Mounting Details.

Section 4 – Installation (continued)

4-8. Receiver Installation.

NOTE

CONNECTING OUTPUTS TO DRIVES.

MOV'S (TRANSIENT PROTECTORS) ARE ON ALL THE OUTPUT RELAYS TO PROTECT THE RELAYS FROM POWER SURGES. MOV'S ALLOW A SMALL LEAKAGE CURRENT THAT CAN AFFECT SOME HIGH IMPEDANCE CIRCUITS. WHEN CONNECTING OUTPUT RELAYS TO DRIVES, IT MAY BE REQUIRED TO REMOVE THE MOV TO PREVENT THE LEAKAGE CURRENT THROUGH THE MOV FROM HOLDING IN THE DRIVE. SEE FIGURE 8-1. RECEIVER LAYOUT FOR THE LOCATION OF THE MOV'S. THE MOV'S ARE NEXT TO THE RELAYS THEY PROTECT. THE MOV'S CAN BE CUT OUT OF THE CIRCUIT WITH A WIRE CUTTER. REMEMBER TO DO THIS WITH ALL POWER OFF ON THE CRANE AND ALL ASSOCIATED CONTROLS.

1. Normally it should not be necessary to set the Access Codes, they are preset. If special field programming is needed. Power the unit up on the bench and pre-program the unit for any special crane configurations or other parameters, if desired, see Section 7 - Programming for details. The unit can be re-programmed after it is installed also.
2. Position the receiver. Locate as far as possible from exposed trolley wire and sources of electromagnetic or radiated noise. Cabinet mounting dimensions and mounting template is on next page see Figure 4-2. Receiver Mounting Details. Antenna should be kept as clear as possible of any metal object.
3. Mount the receiver. The four deep mounting holes in corners of the receiver use quantity four #10-24 combo drive round head screws 1 ½ " in length, four #10 lock washers and four #10-24 hex nuts to mount. Lock washers should be used in front of hex nuts
4. Wire the unit using the appropriate electrical drawings for the specific transmitter and crane orientation selected, see Section 6 - Wiring. If you need to remove the main board (4 screws) the antenna unplugs from the RF Receiver, be sure to dress the antenna cable on the RF Receiver when reinstalling the antenna cable.
5. Wire the power to J1 input power connector. The connections are Ground (GND), Neutral (N) and 115 VAC 60 Hz (115V). See Figure 4-1. Input Power Connections.
6. Wiring of the system should now be complete. **Install antenna.**
7. Turn switch SW2 OFF (MR relay control) and SW1 ON (main power switch). Stand clear of the crane and apply AC power to receiver unit. Check to see if at least the three green LEDs DS1, DS2 and DS3 are ON, as well as two green LEDs on the RX module (other LEDs may be ON also). If none are lit check AC power and power switch SW1. See Figure 8-1. Receiver Layout for switch and LED locations.

Section 4 – Installation (continued)

NOTE:

WHEN FIRST APPLYING POWER TO THE UNIT YOU MUST WAIT 10 SECONDS FOR THE RECEIVER TO GO THROUGH THE PROGRAMMING MODE.

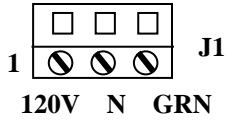
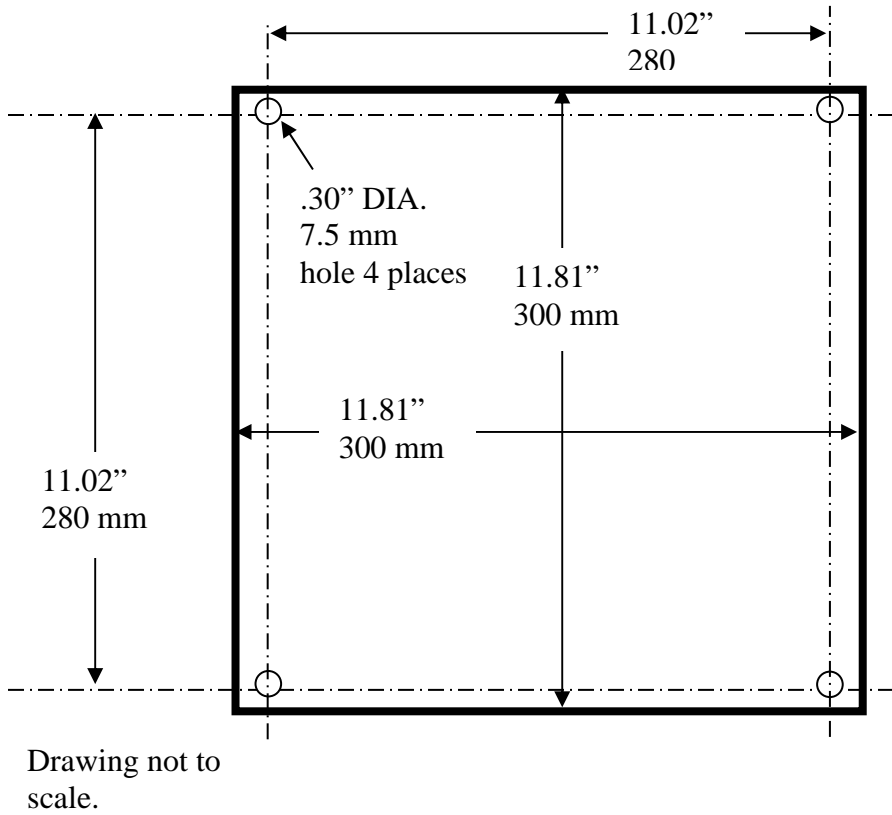

Figure 4-1. Input Power Connections.



Overall Cabinet Depth	With door closed inches	With door closed mm	With door open inches	With door open mm
Cabinet	6.85	173.0	16.0	407.0

Figure 4-2. Receiver Mounting Details

Section 4 – Installation (continued)

Wait 10 seconds and turn the transmitter ON. Check to see if the red LEDs DS30 and DS32 are now ON. At this point the MR relay is disabled; the functions of the transmitter can be checked by noting the turning ON of the appropriate red LEDs next to the control relays (K1-K24). After checking out the functions, turn switch SW2 ON to enable the MR relay (red LED DS31 should now turn ON), check function and direction by jogging each motion. Installation should now be complete.

8. If there are any problems see Section 8 - Servicing.

Section 5
See Appropriate Manual

Section 6 – Wiring

Wiring Diagrams.

The system comes pre-programmed; the following pages in this section have individual wiring diagrams for different crane configurations. Find the appropriate wiring diagram and if necessary program the receiver and transmitter switch settings shown for the appropriate diagram. Terminal designators are marked on the wiring diagram corresponding to designators found on the Receiver Board. For terminal locations see Figure 8-1. Receiver Layout. After selecting the appropriate motors for each function remember to place the appropriate label on your transmitter for describing the appropriate command.

Typically in the following wiring diagrams, the Hoist is shown as Motor 1, Trolley as Motor 2 and Bridge is shown as Motor 3. Make sure the transmitter is labeled with the correct functions. Stick on or movable button labels are provided with the transmitter for proper labeling.

6-1. Installation.

Follow the procedure in Section 4 - Installation for installing the receiver.

6-2. Alarms And Horns.

Make sure that the installation includes the proper alarms, horns, indicator lights and their associated controls as required by local and governmental regulations.

6-3. Relay Sequencing.

The Diagrams in this section show actual relay sequencing. Typically the directional stays in when the second and third speed is actuated.

6-4. Alarm After ESTOP.

This is only for wiring configurations where the Aux 3 (relay K24, output J11-8) is being used for the Alarm function, placing a jumper on JU1 on the Receiver Board will allow the alarm to function after an ESTOP command. See Figure 8-1. Receiver Layout for jumper location.

6-5. Connecting Outputs To Drives.

MOVs (transient protectors) are on all the output relays to protect the relays from power surges. MOVs allow a small leakage current that can affect some high impedance circuits. When connecting output relays to drives, it may be required to remove the MOV to prevent the leakage current through the MOV from holding in the drive. See Figure 8-1. Receiver Layout for the location of the MOVs. The MOVs are next to the relays they protect. The MOVs can be cut out of the circuit with a wire cutter. Remember to do this with ALL power OFF on the crane and all associated controls.

6-6. 2-Speed and 3-Speed transmitter operation.

A 2-Speed *telePendant* or *telePilot* will work on a 3-Speed receiver if the receiver is programmed for “telePendant” operation. The first two speeds will work as normal; the 3rd speed on the receiver will not function. To use a 2-Speed transmitter on a 3-Speed receiver the particular transmitter must have matching frequency, Access Codes and its configuration switches (S3-5, -6 and -7) must all be set to OFF (0). The number of Motors must be selected.

6-7. Commons.

Each receiver relay output (normally open) is independent (floating) both input and output. Relay commons (Hot) are not wired together on the Receiver Board nor connected to the input power. Relay common wiring must be provided. This is to give total flexibility. Different motors and/or functions can use different phases or independent (even DC) power sources.

6-8. Power or Hot routing.

The Diagrams in this Section show independent power “HOT” routed to each relay. An alternate way of routing power is to route all power to each function from the MR (Master Relay) relay. This wiring can only be used if the total current does not exceed the MR relay ratings.

Section 6 - Wiring (Continued)

6-9. The following is the legend for the wiring diagrams below:

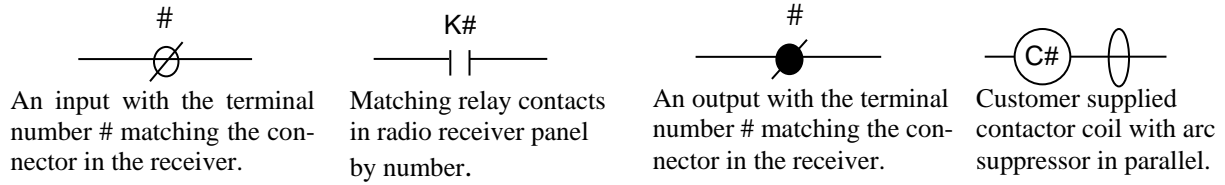
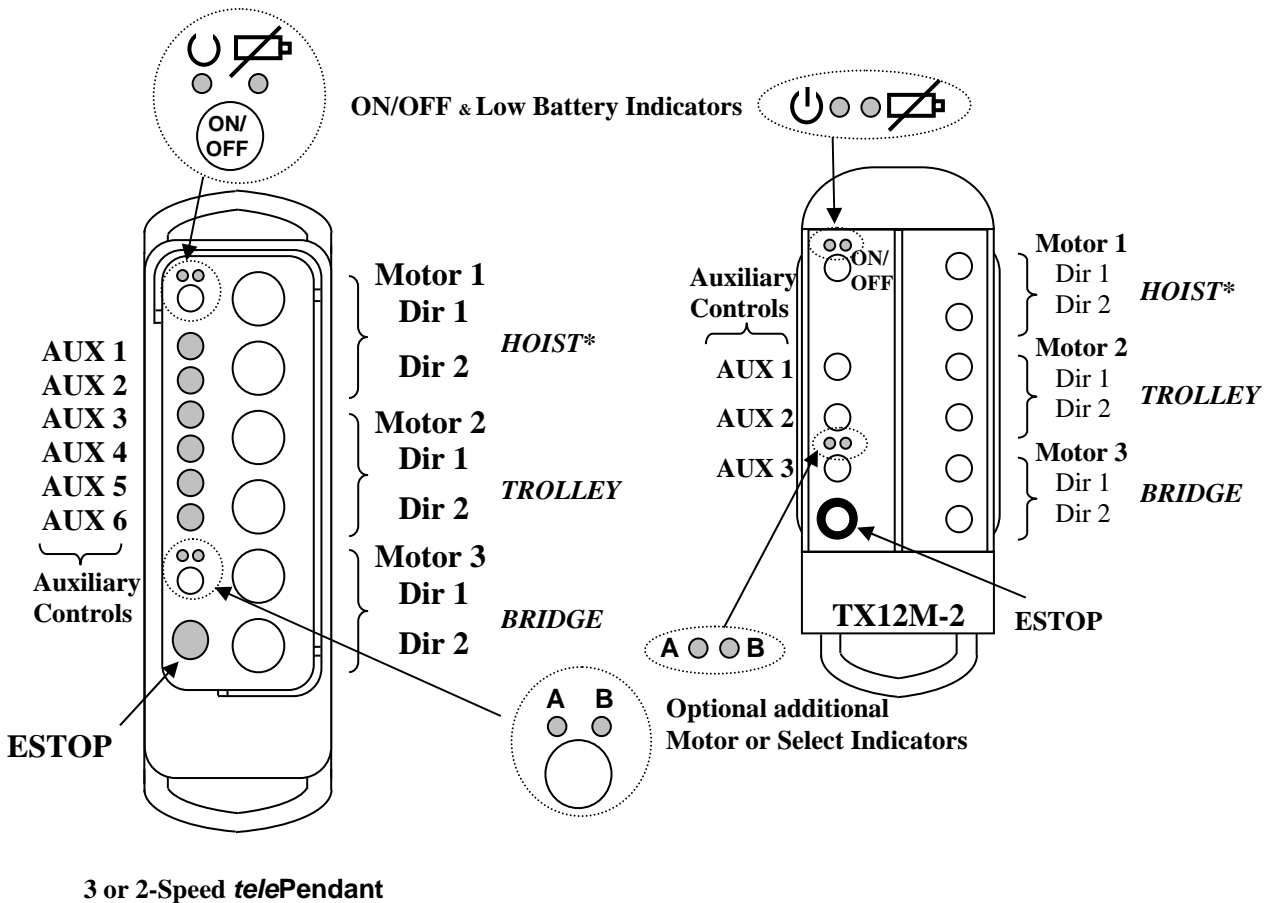

Figure 6-1. Legend.



*NOTE: Hoist, Trolley and Bridge are listed here as traditional configurations, the installer may choose to define the motors differently.

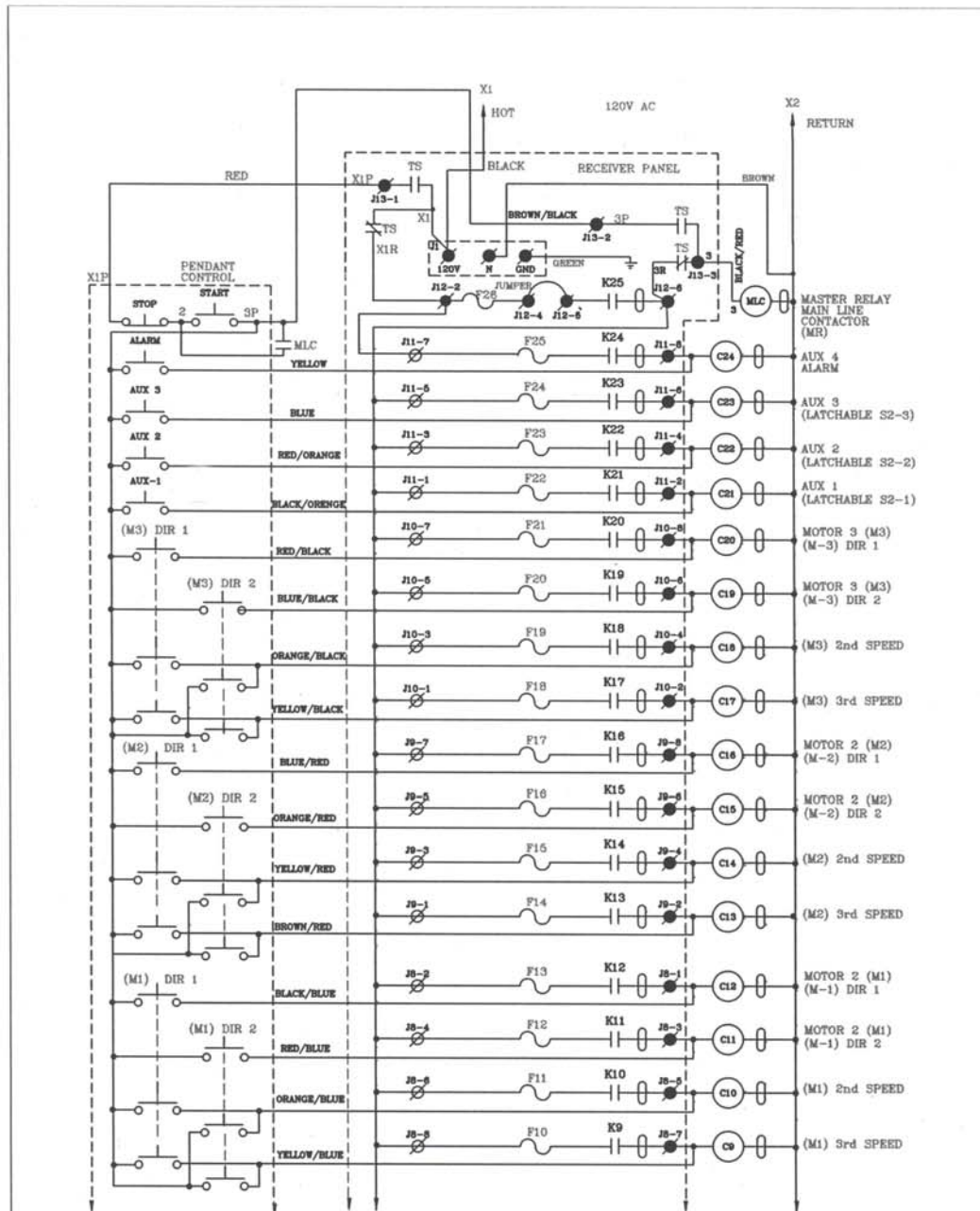

Figure 6-2. telePilot and telePendant, Output Controls.

Section 6 - Wiring (Continued)



CONTINUED TO SHEET 2

SHEET 1 OF 2

 INDICATES SUPPRESSOR IN PARALLEL WITH COIL OR CONTACT
 TS INDICATES TRANSFER SWITCH IN RADIO POSITION

TYPICAL 5 MOTOR 3 SPEED STANDARD CONTROL IS SHOWN FOR REFERENCE.

RADIO OUTPUT CONTACTS K9 THRU K24 ARE USER PROGRAMMABLE IF REQUIRED.



telemotive INDUSTRIAL
a Magnetek company
175 Wall Street Glendale Heights, IL 60139-1005
Phone: (630) 582-1111 FAX: (630) 582-1194

TR24 3 SPEED PROGRAMMABLE RECEIVER WIRING
WITH CABLE & INTERNAL TRANSFER SWITCH



USER						
JOB	TR24-PT	DRN	CP	CHKD	C.P.	APP'VD
SCALE	DATE	DRAWING No				
REF			RC-E801-TR24-PT			

Wiring for Internal Transfer Switch using Optional Pigtail.

Section 6 - Wiring (Continued)

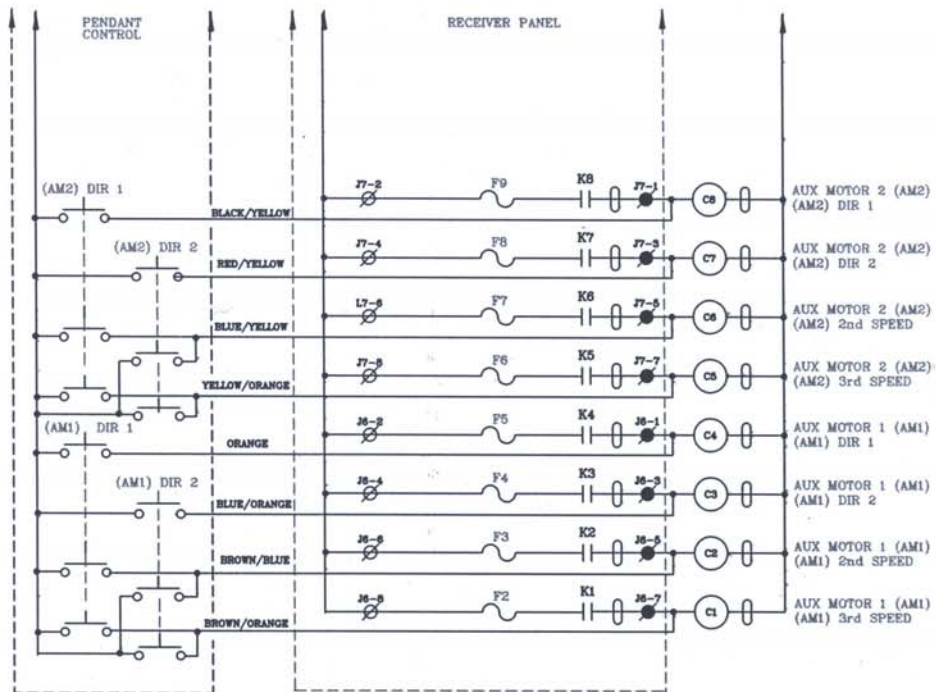
CONTINUED FROM SHEET 1



 INDICATES SUPPRESSOR IN PARALLEL WITH COIL OR CONTACT
 TS INDICATES TRANSFER SWITCH IN RADIO POSITION

TYPICAL 5 MOTOR 3 SPEED STANDARD CONTROL IS SHOWN FOR REFERENCE.

RADIO OUTPUT CONTACTS K8 THRU K1 ARE USER PROGRAMMABLE IF REQUIRED.

SHEET 2 OF 2

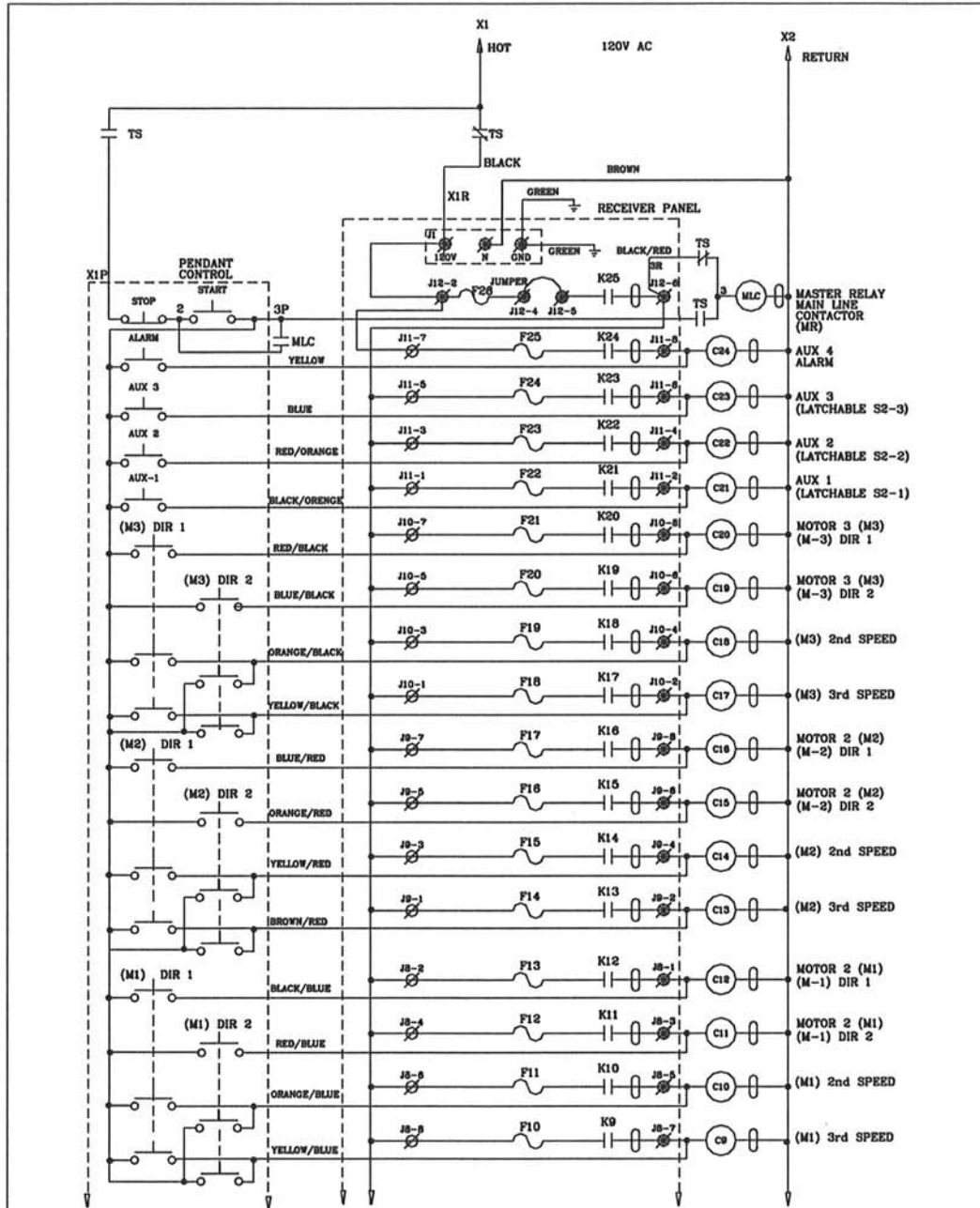

 telemotive INDUSTRIAL CONTROLS a Magnetek company 175 Wall Street Glendale Heights, IL 60139-1985 Phone: (630) 582-1111 FAX: (630) 582-1194						
		TR24 3 SPEED PROGRAMMABLE RECEIVER WIRING WITH CABLE & INTERNAL TRANSFER SWITCH				
USER						
JOB	TR24-PT	DRN	CP	CHDD	C.P.	APP'VD
SCALE		DATE	1/28/04	DRAWING No		
REF	RC-E801-TR24-PT					

Section 6 - Wiring (Continued)



CONTINUED TO SHEET 2

SHEET 1 OF 2

 INDICATES SUPPRESSOR IN PARALLEL WITH COIL OR CONTACT
 TS INDICATES TRANSFER SWITCH IN RADIO POSITION

TYPICAL 5 MOTOR 3 SPEED STANDARD CONTROL IS SHOWN FOR REFERENCE.

RADIO OUTPUT CONTACTS K9 THRU K24 ARE USER PROGRAMMABLE IF REQUIRED.

 **telemotive** INDUSTRIAL CONTROLS
 a Magnetek company
 175 Wall Street Glendale Heights, IL 60139-1985
 Phone: (630) 582-1111 FAX: (630) 582-1194

TR24 3 SPEED PROGRAMMABLE RECEIVER WIRING WITH CABLE & EXTERNAL TRANSFER SWITCH

USER



JOB	TR24-P	DRN	CP	CHKD	C.P.	APP'VD
SCALE	DATE		1/28/04		DRAWING No	
REP						RC-E801-TR24-P

Wiring for External Transfer Switch using Optional Pigtail.

Section 6 - Wiring (Continued)

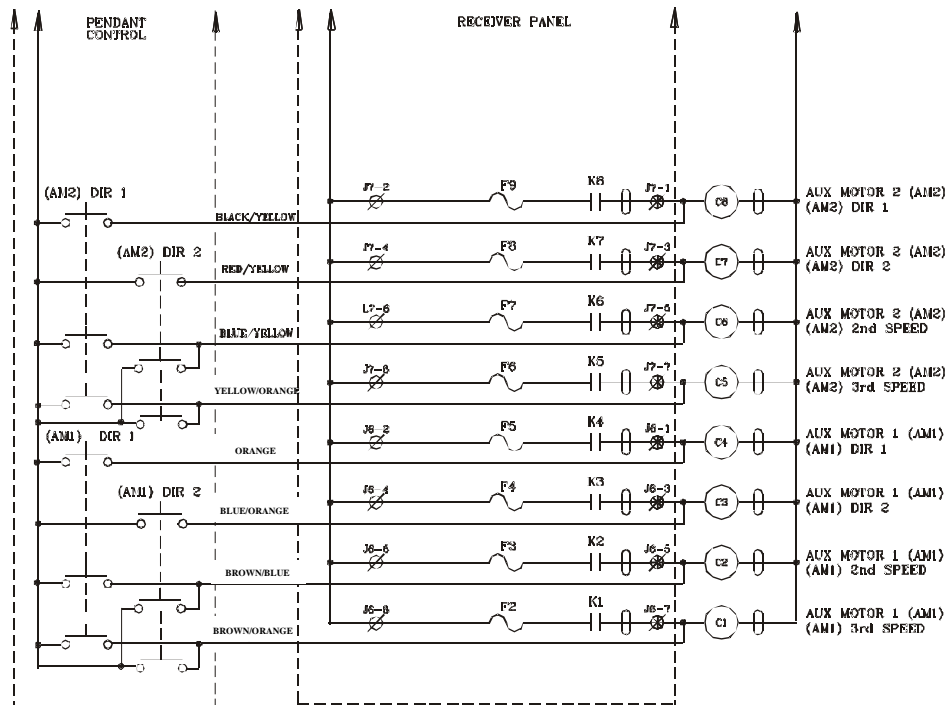
CONTINUED FROM SHEET 1



 INDICATES SUPPRESSOR IN PARALLEL WITH COIL OR CONTACT
 TS INDICATES TRANSFER SWITCH IN RADIO POSITION

TYPICAL 5 MOTOR 3 SPEED STANDARD CONTROL IS SHOWN FOR REFERENCE.

RADIO OUTPUT CONTACTS K8 THRU K1 ARE USER PROGRAMMABLE IF REQUIRED.

SHEET 2 OF 2

 telemotive INDUSTRIAL CONTROLS a Magnetek company 175 Wall Street Clendale Heights, IL 60139-1985 Phone: (630) 582-1111 FAX: (630) 582-1194						
TR24 3 SPEED PROGRAMMABLE RECEIVER WIRING WITH CABLE & EXTERNAL TRANSFER SWITCH						
USER						
#38	TR24-P	DRN	CP	CHKD	C.P.	APP'D
SCALE	DATE		DRAWING No			
REP					RC-E801-TR24-P	

Section 6 - Wiring (Continued)

TABLE 2(A) 3-SPEED WIRING DIAGRAM.

STANDARD CONFIGURATION HOIST, AUX HOIST, TROLLEY, AUX TROLLEY and BRIDGE

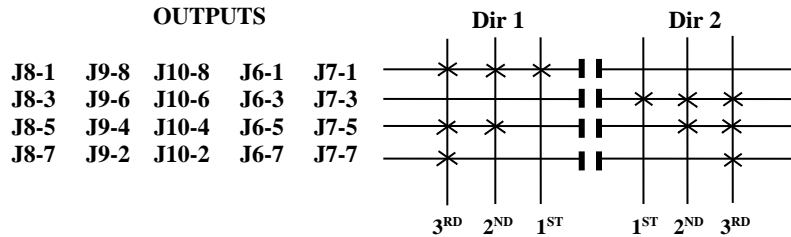

MOTOR 1 CONNECTIONS

J8-1 *HOIST* UP
 J8-3 *HOIST* DOWN
 J8-5 *HOIST* 2ND SPEED
 J8-7 *HOIST* 3RD SPEED
 J8-1, 3, 5 & 7 HOT (J8-2, 4, 6 & 8)

MOTOR 2 CONNECTIONS

J9-8 *TROLLEY* DIR 1
 J9-6 *TROLLEY* DIR 2
 J9-4 *TROLLEY* 2ND SPEED
 J9-2 *TROLLEY* 3RD SPEED
 J9-2, 4, 6 & 8 HOT (J9-1, 3, 5 & 7)

MOTOR 3 CONNECTIONS

J10-8 *BRIDGE* DIR 1
 J10-6 *BRIDGE* DIR 2
 J10-4 *BRIDGE* 2ND SPEED
 J10-2 *BRIDGE* 3RD SPEED
 J10-2, 4, 6 & 8 HOT (J10-1, 3, 5 & 7)

AUX MOTOR 1 CONNECTIONS

J6-1 *AUX HOIST* UP
 J6-3 *AUX HOIST* DOWN
 J6-5 *AUX HOIST* 2ND SPEED
 J6-7 *AUX HOIST* 3RD SPEED
 J6-1, 3, 5 & 7 HOT (J6-2, 4, 6 & 8)

AUX MOTOR 2 CONNECTIONS

J7-1 *AUX TROLLEY* DIR 1
 J7-3 *AUX TROLLEY* DIR 2
 J7-5 *AUX TROLLEY* 2ND SPEED
 J7-7 *AUX TROLLEY* 3RD SPEED
 J7-1, 3, 5 & 7 HOT (J7-2, 4, 6 & 8)

INDEPENDENT OUTPUTS

J11-2 *AUX 1 (LATCH S2-1) HOT* J11-1
 J11-4 *AUX 2 (LATCH S2-2) HOT* J11-3
 J11-6 *AUX 3 (LATCH S2-3) HOT* J11-5
 J11-8 *AUX 4 (ALARM) HOT* J11-7

RECEIVER And TRANSMITTER SWITCH SETTINGS

In the Receiver use the PDA Receiver Programmer to:

- Set “Receiver access code” and “Frequency”.
- In the “Receiver Programmer” screen, select under “System” “24 output”.
- In the “Set Status Words” screen, set RX and TX Status Word Switches S1 to S4 as shown below:

X’s are normally OFF (0) but may be turned ON (1) to enable additional features detailed in Section 7-11. Status Word Programming.

Switch #	Position							
	1	2	3	4	5	6	7	8
Rx S1	X	X	X	*0	1	X	X	X
Tx S3	X	X	X	0	0	0	0	0

Switch #	Position							
	1	2	3	4	5	6	7	8
Rx S2	X	X	X	0	0	0	X	X
Tx S4	0	0	0	0	0	0	0	0

In the transmitter:

- 3-Speed *telePendant* use the PDA Transmitter Programmer to:
 - Set “Receiver access code” and “Frequency”. (Must be same as receiver).
 - Select under “Tx Type” “3 SPD telePendant”.
 - Select under “Motor” the number “5”.
- **MLTX, SLTX and JLTX**
 - In the table above, program Rx S1 position 4 ON (1).
 - In the transmitter turn switches SW3 “C” positions 1 through 7 and SW4 “D” positions 1 through 8 OFF. (SW3 “C” Position 8 ON disables the transmitter 15 minute time-out timer).

NOTE: *HOIST*, *TROLLEY* and *BRIDGE* are listed here as traditional configurations, the installer may choose to define the motors differently.

Section 6 - Wiring (Continued)

**TABLE 2(A) 3-SPEED WIRING DIAGRAM.
STANDARD CONFIGURATION HOIST, TROLLEY and BRIDGE
with 6 INDEPENDENT AUXILIARIES.**

The outputs listed below match the button labels as defined in Figure 6-2.

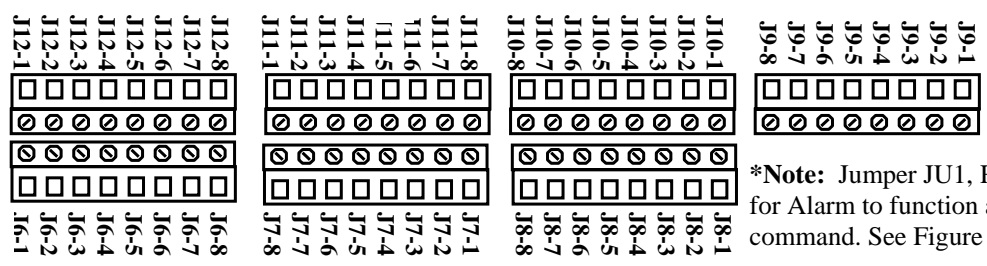
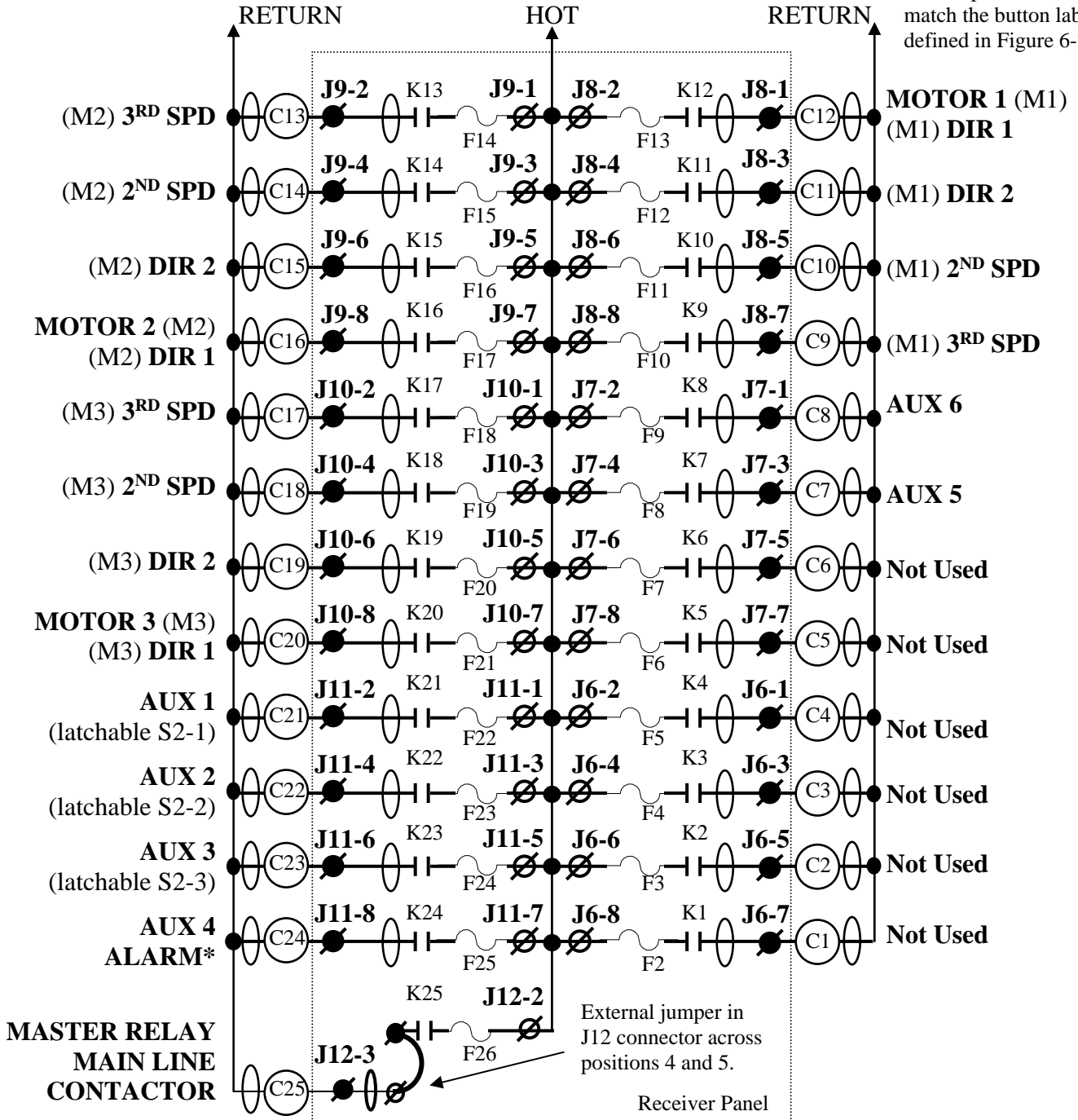

*Note: Jumper JU1, Receiver Board for Alarm to function after an E-Stop command. See Figure 8-1.

Section 6 – Wiring

**TABLE 2(A) 3-SPEED WIRING DIAGRAM.
STANDARD CONFIGURATION HOIST, TROLLEY and BRIDGE**

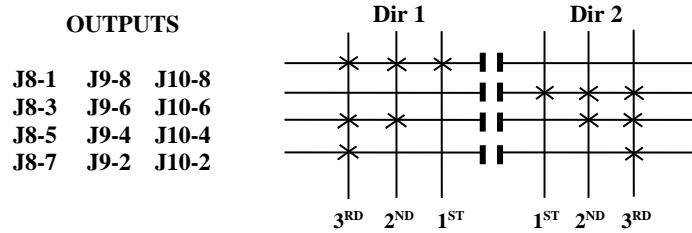

MOTOR 1 CONNECTIONS

J8-1 *HOIST* UP
 J8-3 *HOIST* DOWN
 J8-5 *HOIST* 2ND SPEED
 J8-7 *HOIST* 3RD SPEED
 J8-1, 3, 5 & 7 HOT (J8-2, 4, 6 & 8)

MOTOR 2 CONNECTIONS

J9-8 *TROLLEY* DIR 1
 J9-6 *TROLLEY* DIR 2
 J9-4 *TROLLEY* 2ND SPEED
 J9-2 *TROLLEY* 3RD SPEED
 J9-2, 4, 6 & 8 HOT (J9-1, 3, 5 & 7)

MOTOR 3 CONNECTIONS

J10-8 *BRIDGE* DIR 1
 J10-6 *BRIDGE* DIR 2
 J10-4 *BRIDGE* 2ND SPEED
 J10-2 *BRIDGE* 3RD SPEED
 J10-2, 4, 6 & 8 HOT (J10-1, 3, 5 & 7)

INDEPENDENT OUTPUTS

J11-2 AUX 1 (LATCH S2-1) HOT J11-1
 J11-4 AUX 2 (LATCH S2-2) HOT J11-3
 J11-6 AUX 3 (LATCH S2-3) HOT J11-5
 J11-8 AUX 4 (ALARM) HOT J11-7

INDEPENDENT OUTPUTS

J11-2, 4, 6 & 8 HOT (J11-1, 3, 5 & 7)
 J7-3 AUX 5
 J7-1 AUX 6
 J7-1 & 3 HOT (J7-2 & 4)

RECEIVER And TRANSMITTER SWITCH SETTINGS

In the Receiver use the PDA Receiver Programmer to:

- Set “Receiver access code” and “Frequency”.
- In the “Receiver Programmer” screen, select under “System” “16 output”.
- In the “Set Status Words” screen, set RX and TX Status Word Switches S1 to S4 as shown below:

X’s are normally OFF (0) but may be turned ON (1) to enable additional features detailed in Section 7-11. Status Word Programming.

	Position							
Switch #	1	2	3	4	5	6	7	8
Rx S1	X	X	X	*0	0	X	X	X
Rx S2	X	X	X	0	0	0	X	X
Tx S3	X	X	X	0	0	0	0	0
Tx S4	0	0	0	0	0	0	0	0

In the transmitter:

- **3-Speed telePendant** use the PDA Transmitter Programmer to:
 - Set “Receiver access code” and “Frequency”. (Must be same as receiver).
 - Select under “Tx Type” “3 SPD telePendant”.
 - Select under “Motor” the number “3”.
- **MLTX, SLTX and JLTX**
 - In the table above, program Rx S1 position 4 ON (1).
 - In the transmitter turn switches SW3 “C” positions 1 through 7 and SW4 “D” positions 1 through 8 OFF. (SW3 “C” Position 8 ON disables the transmitter 15 minute time-out timer).

NOTE: *HOIST*, *TROLLEY* and *BRIDGE* are listed here as traditional configurations, the installer may choose to define the motors differently.

Section 6 - Wiring (Continued)

**TABLE 2(A) 3-SPEED WIRING DIAGRAM.
STANDARD CONFIGURATION HOIST, AUX HOIST, TROLLEY,
AUX TROLLEY and BRIDGE with SELECT LOGIC.**

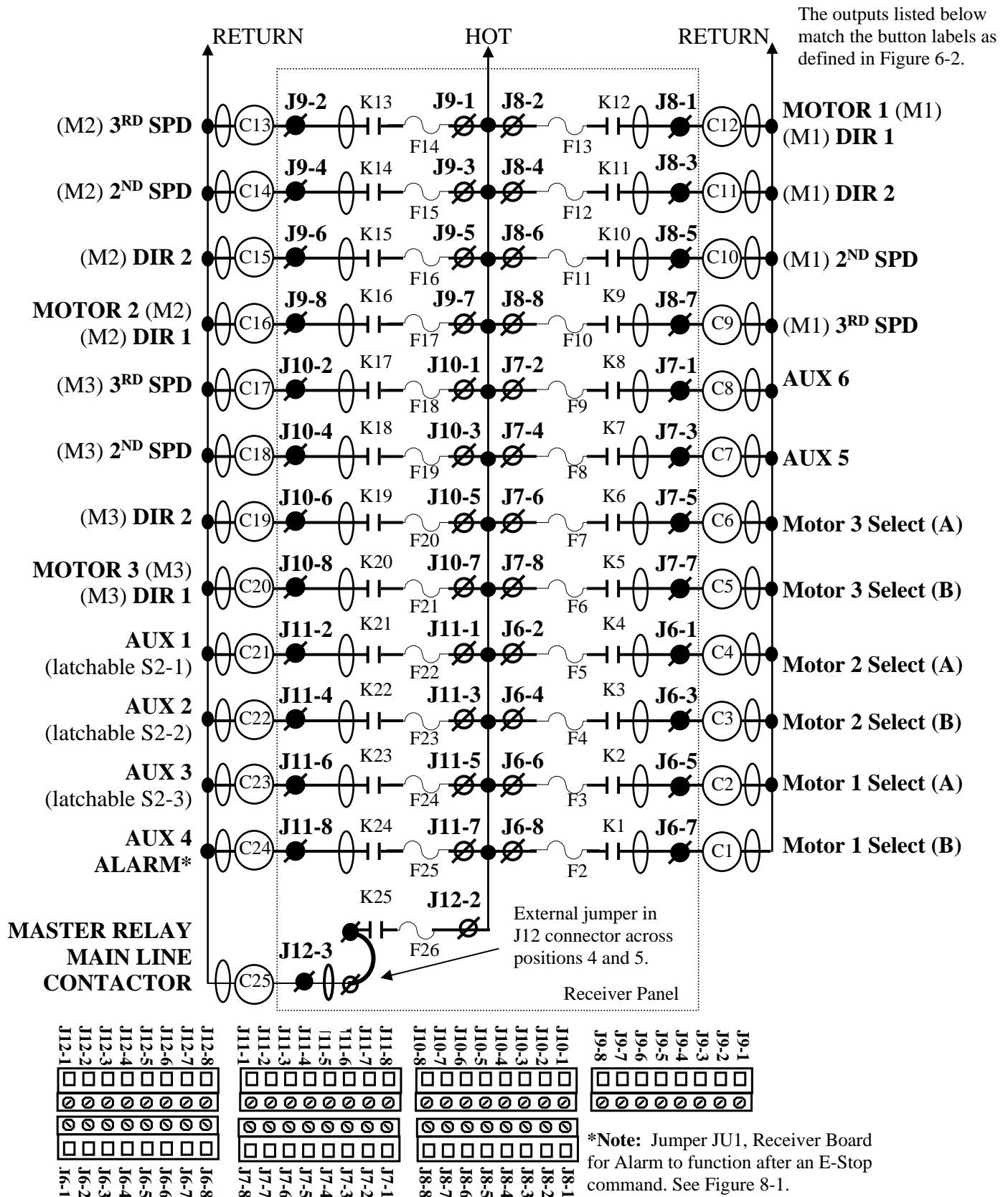

Section 6 – Wiring (continued)

TABLE 2(A) 3-SPEED WIRING DIAGRAM.

STANDARD CONFIGURATION HOIST, AUX HOIST, TROLLEY, AUX TROLLEY and BRIDGE

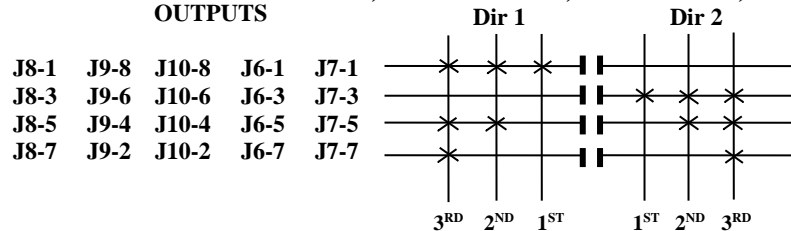

MOTOR 1 CONNECTIONS

J8-1 *HOIST UP*
 J8-3 *HOIST DOWN*
 J8-5 *HOIST 2ND SPEED*
 J8-7 *HOIST 3RD SPEED*
 J8-1, 3, 5 & 7 HOT (J8-2, 4, 6 & 8)

MOTOR 2 CONNECTIONS

J9-8 *TROLLEY DIR 1*
 J9-6 *TROLLEY DIR 2*
 J9-4 *TROLLEY 2ND SPEED*
 J9-2 *TROLLEY 3RD SPEED*
 J9-2, 4, 6 & 8 HOT (J9-1, 3, 5 & 7)

MOTOR 3 CONNECTIONS

J10-8 *BRIDGE DIR 1*
 J10-6 *BRIDGE DIR 2*
 J10-4 *BRIDGE 2ND SPEED*
 J10-2 *BRIDGE 3RD SPEED*
 J10-2, 4, 6 & 8 HOT (J10-1, 3, 5 & 7)

AUX MOTOR 1 CONNECTIONS

J6-1 *MOTOR 2 SELECT (A)*
 J6-3 *MOTOR 2 SELECT (B)*
 J6-5 *MOTOR 1 SELECT (A)*
 J6-7 *MOTOR 1 SELECT (B)*
 J6-1, 3, 5 & 7 HOT (J6-2, 4, 6 & 8)

AUX MOTOR 2 CONNECTIONS

J7-1 *AUX 6*
 J7-3 *AUX 5*
 J7-5 *MOTOR 3 SELECT (A)*
 J7-7 *MOTOR 3 SELECT (B)*
 J7-1, 3, 5 & 7 HOT (J7-2, 4, 6 & 8)

INDEPENDENT OUTPUTS

J11-2 *AUX 1 (LATCH S2-1) HOT J11-1*
 J11-4 *AUX 2 (LATCH S2-2) HOT J11-3*
 J11-6 *AUX 3 (LATCH S2-3) HOT J11-5*
 J11-8 *AUX 4 (ALARM) HOT J11-7*

RECEIVER And TRANSMITTER SWITCH SETTINGS

In the Receiver use the PDA Receiver Programmer to:

- Set “Receiver access code” and “Frequency”.
- In the “Receiver Programmer” screen, select under “System” “24 output”.
- In the “Set Status Words” screen, set RX and TX Status Word Switches S1 to S4 as shown below:

X’s are normally OFF (0) but may be turned ON (1) to enable additional features detailed in Section 7-11. Status Word Programming.

Switch #	Position							
	1	2	3	4	5	6	7	8
Rx S1	X	X	X	*0	1	X	X	X
Tx S3	X	X	X	0	0	0	0	0

Switch #	Position							
	1	2	3	4	5	6	7	8
Rx S2	X	X	X	0	0	0	X	X
Tx S4	1	0	0	0	0	0	0	0

In the transmitter:

- 3-Speed *telePendant* use the PDA Transmitter Programmer to:
 - Set “Receiver access code” and “Frequency”. (Must be same as receiver).
 - Select under “Tx Type” “3 SPD telePendant”.
 - Select under “Motor” the number “5”.
- MLTX, SLTX and JLTX
 - In the table above, program Rx S1 position 4 ON (1).
 - In the transmitter turn switches SW3 “C” positions 1 through 7 and SW4 “D” positions 1 through 8 OFF. (SW3 “C” Position 8 ON disables the transmitter 15 minute time-out timer).

NOTE: *HOIST*, *TROLLEY* and *BRIDGE* are listed here as traditional configurations, the installer may choose to define the motors differently.

Section 6 - Wiring (Continued)

**TABLE 2(B) 2-SPEED WIRING DIAGRAM.
DIRECTIONAL CONTROLS ALL MOTIONS**

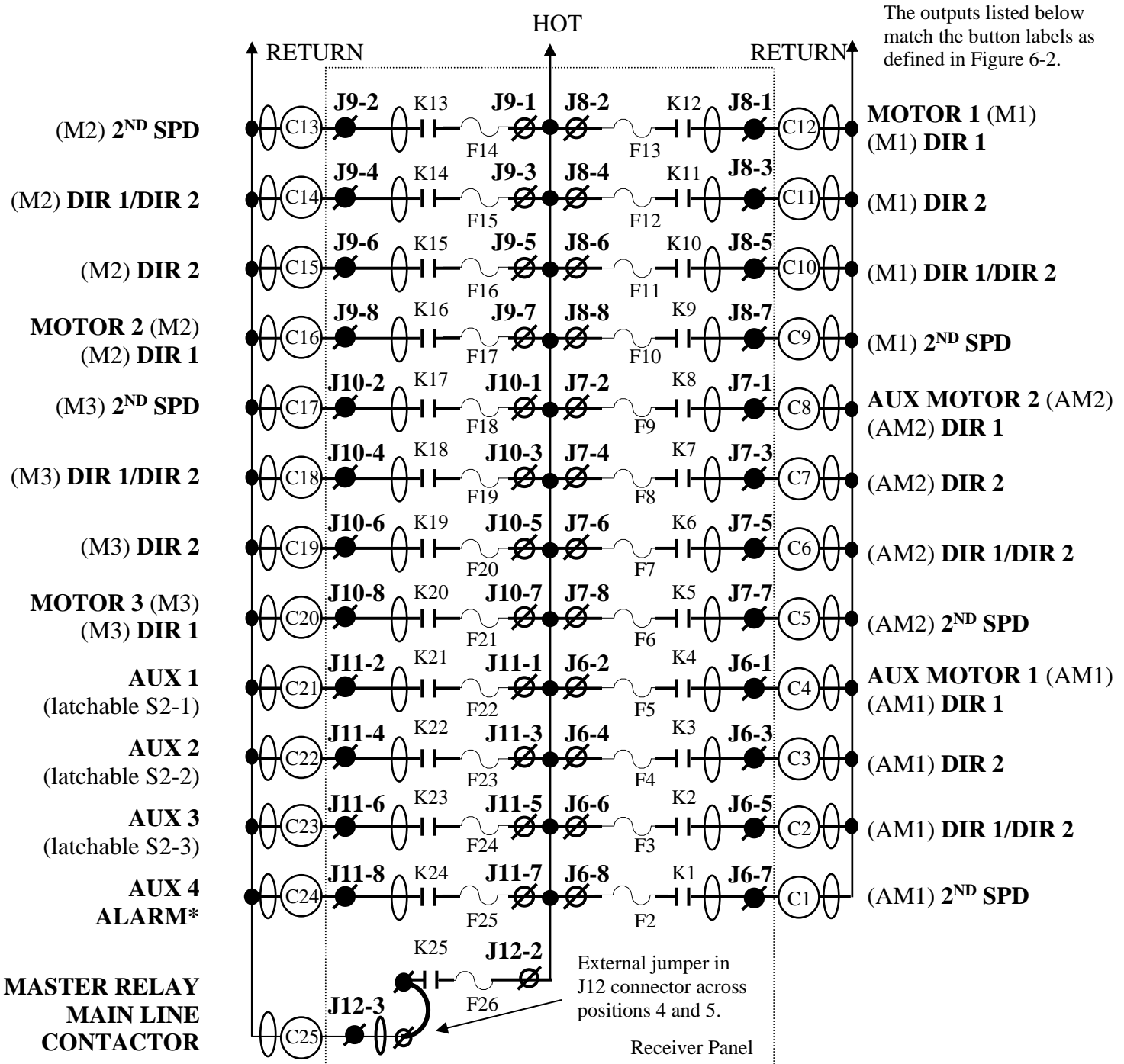

The outputs listed below match the button labels as defined in Figure 6-2.

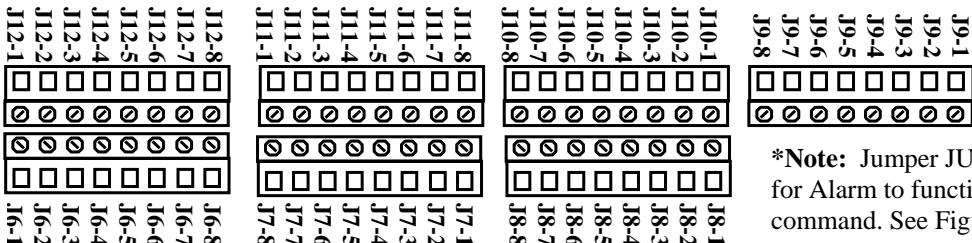

***Note:** Jumper JU1, Receiver Board for Alarm to function after an E-Stop command. See Figure 8-1.

Section 6 - Wiring (Continued)

**TABLE 2(B) 2-SPEED WIRING DIAGRAM.
DIRECTIONAL CONTROLS ALL MOTIONS**

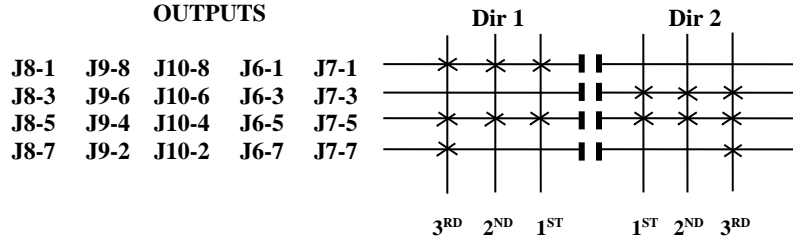

MOTOR 1 CONNECTIONS

J8-1 *HOIST UP*
 J8-3 *HOIST DOWN*
 J8-5 *HOIST UP/DOWN*
 J8-7 *HOIST 2ND SPEED*
 J8-1, 3, 5 & 7 HOT (J8-2, 4, 6 & 8)

MOTOR 2 CONNECTIONS

J9-8 *TROLLEY DIR 1*
 J9-6 *TROLLEY DIR 2*
 J9-4 *TROLLEY DIR 1/DIR 2*
 J9-2 *TROLLEY 2ND SPEED*
 J9-2, 4, 6 & 8 HOT (J9-1, 3, 5 & 7)

MOTOR 3 CONNECTIONS

J10-8 *BRIDGE DIR 1*
 J10-6 *BRIDGE DIR 2*
 J10-4 *BRIDGE DIR 1/DIR 2*
 J10-2 *BRIDGE 2ND SPEED*
 J10-2, 4, 6 & 8 HOT (J10-1, 3, 5 & 7)

AUX MOTOR 1 CONNECTIONS

J6-1 *AUX HOIST UP*
 J6-3 *AUX HOIST DOWN*
 J6-5 *AUX HOIST DIR 1/DIR 2*
 J6-7 *AUX HOIST 2ND SPEED*
 J6-1, 3, 5 & 7 HOT (J6-2, 4, 6 & 8)

AUX MOTOR 2 CONNECTIONS

J7-1 *AUX TROLLEY DIR 1*
 J7-3 *AUX TROLLEY DIR 2*
 J7-5 *AUX TROLLEY DIR 1/DIR 2*
 J7-7 *AUX TROLLEY 2ND SPEED*
 J7-1, 3, 5 & 7 HOT (J7-2, 4, 6 & 8)

INDEPENDENT OUTPUTS

J11-2 *AUX 1 (LATCH S2-1) HOT* J11-1
 J11-4 *AUX 2 (LATCH S2-2) HOT* J11-3
 J11-6 *AUX 3 (LATCH S2-3) HOT* J11-5
 J11-8 *AUX 4 (ALARM) HOT* J11-7

RECEIVER And TRANSMITTER SWITCH SETTINGS

In the Receiver use the PDA Receiver Programmer to:

- Set “Receiver access code” and “Frequency”.
- In the “Receiver Programmer” screen, select under “System” “24 output”.
- In the “Set Status Words” screen, set RX and TX Status Word Switches S1 to S4 as shown below:

X’s are normally OFF (0) but may be turned ON (1) to enable additional features detailed in Section 7-11. Status Word Programming.

Switch #	Position							
	1	2	3	4	5	6	7	8
Rx S1	X	X	X	*0	1	X	X	X
Tx S3	X	X	X	0	1	0	0	0

Switch #	Position							
	1	2	3	4	5	6	7	8
Rx S2	X	X	X	0	0	0	X	X
Tx S4	0	0	0	0	0	0	0	0

In the transmitter:

- 3-Speed *telePendant* use the PDA Transmitter Programmer to:
 - Set “Receiver access code” and “Frequency”. (Must be same as receiver).
 - Select under “Tx Type” “3 SPD telePendant”.
 - Select under “Motor” the number “5”.
- MLTX, SLTX and JLTX
 - In the table above, program Rx S1 position 4 ON (1).
 - In the transmitter turn switches SW3 “C” positions 1 through 7 and SW4 “D” positions 1 through 8 OFF. (SW3 “C” Position 8 ON disables the transmitter 15 minute time-out timer).

NOTE: *HOIST*, *TROLLEY* and *BRIDGE* are listed here as traditional configurations, the installer may choose to define the motors differently.

Section 6 - Wiring (Continued)

**TABLE 2(C) 3-SPEED WIRING DIAGRAM.
2-WINDINGS: ALL MOTIONS**

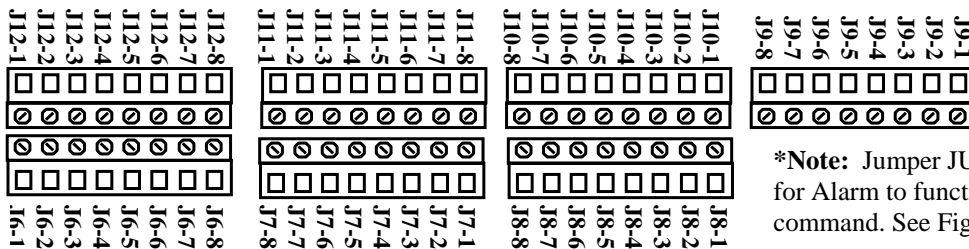
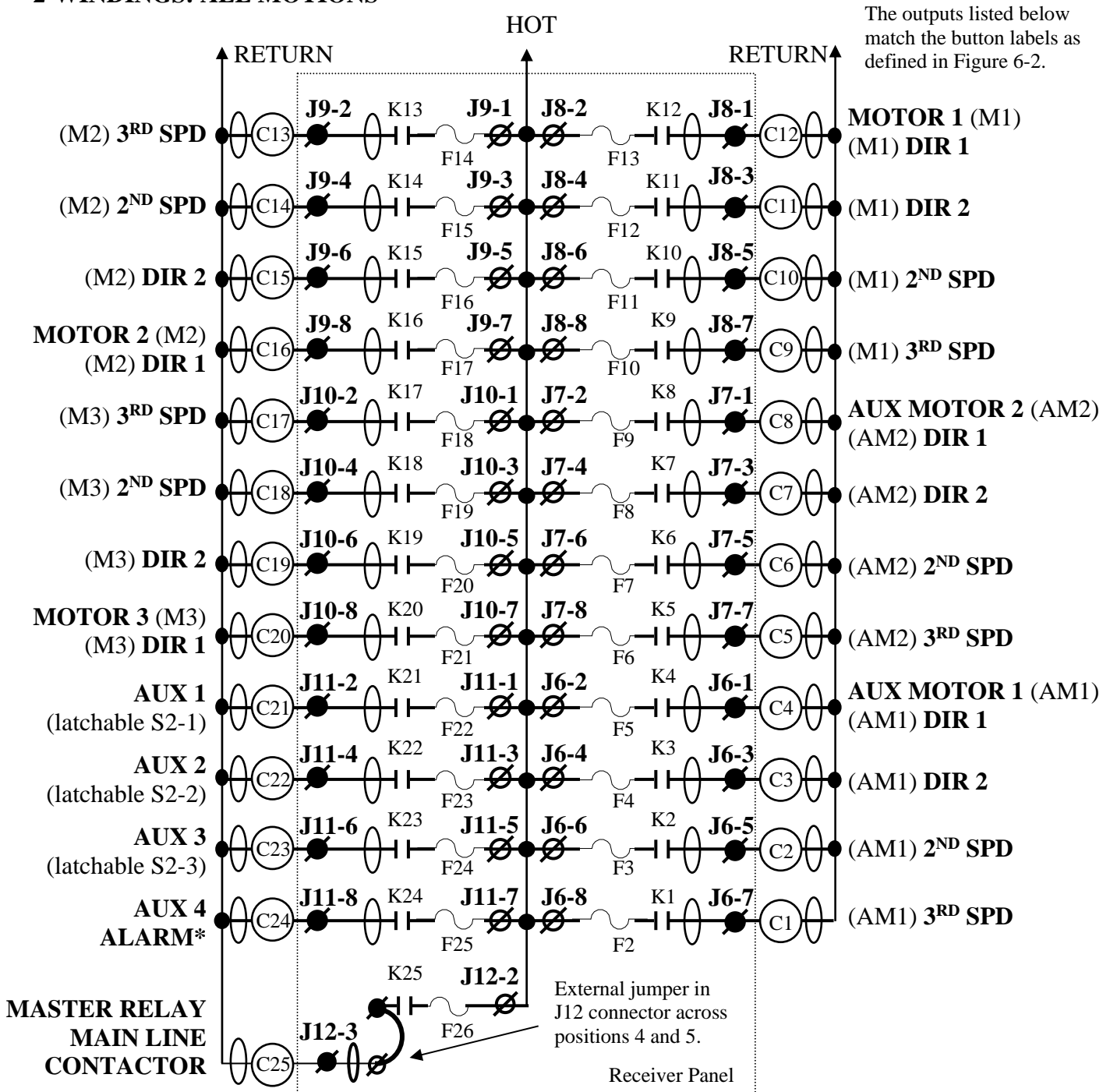

*Note: Jumper JU1, Receiver Board for Alarm to function after an E-Stop command. See Figure 8-1.

Section 6 - Wiring (Continued)

TABLE 2(C) 3-SPEED WIRING DIAGRAM.

2-WINDINGS: ALL MOTIONS

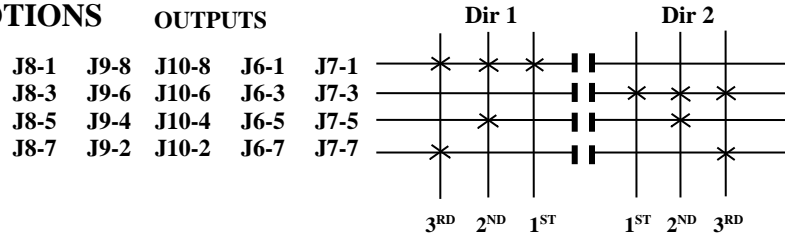

MOTOR 1 CONNECTIONS

- J8-1 *HOIST* UP
- J8-3 *HOIST* DOWN
- J8-5 *HOIST* 1ST SPEED
- J8-7 *HOIST* 2ND SPEED
- J8-1, 3, 5 & 7 HOT (J8-2, 4, 6 & 8)

MOTOR 2 CONNECTIONS

- J9-8 *TROLLEY* DIR 1
- J9-6 *TROLLEY* DIR 2
- J9-4 *TROLLEY* 1ST SPEED
- J9-2 *TROLLEY* 2ND SPEED
- J9-2, 4, 6 & 8 HOT (J9-1, 3, 5 & 7)

MOTOR 3 CONNECTIONS

- J10-8 *BRIDGE* DIR 1
- J10-6 *BRIDGE* DIR 2
- J10-4 *BRIDGE* 1ST SPEED
- J10-2 *BRIDGE* 2ND SPEED
- J10-2, 4, 6 & 8 HOT (J10-1, 3, 5 & 7)

AUX MOTOR 1 CONNECTIONS

- J6-1 *AUX HOIST* UP
- J6-3 *AUX HOIST* DOWN
- J6-5 *AUX HOIST* 1ST SPEED
- J6-7 *AUX HOIST* 2ND SPEED
- J6-1, 3, 5 & 7 HOT (J6-2, 4, 6 & 8)

AUX MOTOR 2 CONNECTIONS

- J7-1 *AUX TROLLEY* DIR 1
- J7-3 *AUX TROLLEY* DIR 2
- J7-5 *AUX TROLLEY* 1ST SPEED
- J7-7 *AUX TROLLEY* 2ND SPEED
- J7-1, 3, 5 & 7 HOT (J7-2, 4, 6 & 8)

INDEPENDENT OUTPUTS

- J11-2 AUX 1 (LATCH S2-1) HOT J11-1
- J11-4 AUX 2 (LATCH S2-2) HOT J11-3
- J11-6 AUX 3 (LATCH S2-3) HOT J11-5
- J11-8 AUX 4 (ALARM) HOT J11-7

RECEIVER And TRANSMITTER SWITCH SETTINGS

In the Receiver use the PDA Receiver Programmer to:

- Set “Receiver access code” and “Frequency”.
- In the “Receiver Programmer” screen, select under “System” “24 output”.
- In the “Set Status Words” screen, set RX and TX Status Word Switches S1 to S4 as shown below:

X’s are normally OFF (0) but may be turned ON (1) to enable additional features detailed in Section 7-11. Status Word Programming.

Switch #	Position							
	1	2	3	4	5	6	7	8
Rx S1	X	X	X	*0	1	X	X	X
Tx S3	X	X	X	0	0	1	0	0

Switch #	Position							
	1	2	3	4	5	6	7	8
Rx S2	X	X	X	0	0	0	X	X
Tx S4	0	0	0	0	0	0	0	0

In the transmitter:

- **3-Speed telePendant** use the PDA Transmitter Programmer to:
 - Set “Receiver access code” and “Frequency”. (Must be same as receiver).
 - Select under “Tx Type” “3 SPD telePendant”.
 - Select under “Motor” the number “5”.
- **MLTX, SLTX and JLTX**
 - In the table above, program Rx S1 position 4 ON (1).
 - In the transmitter turn switches SW3 “C” positions 1 through 7 and SW4 “D” positions 1 through 8 OFF. (SW3 “C” Position 8 ON disables the transmitter 15 minute time-out timer).

NOTE: *HOIST*, *TROLLEY* and *BRIDGE* are listed here as traditional configurations, the installer may choose to define the motors differently.

Section 6 - Wiring (Continued)

**TABLE 2(D) 2-SPEED WIRING DIAGRAM
ACCO CONTROLS: ALL MOTIONS**

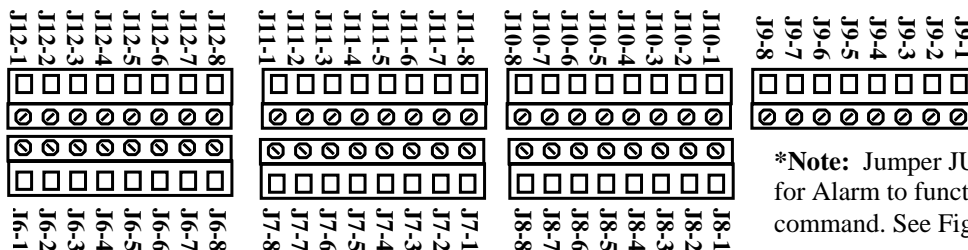
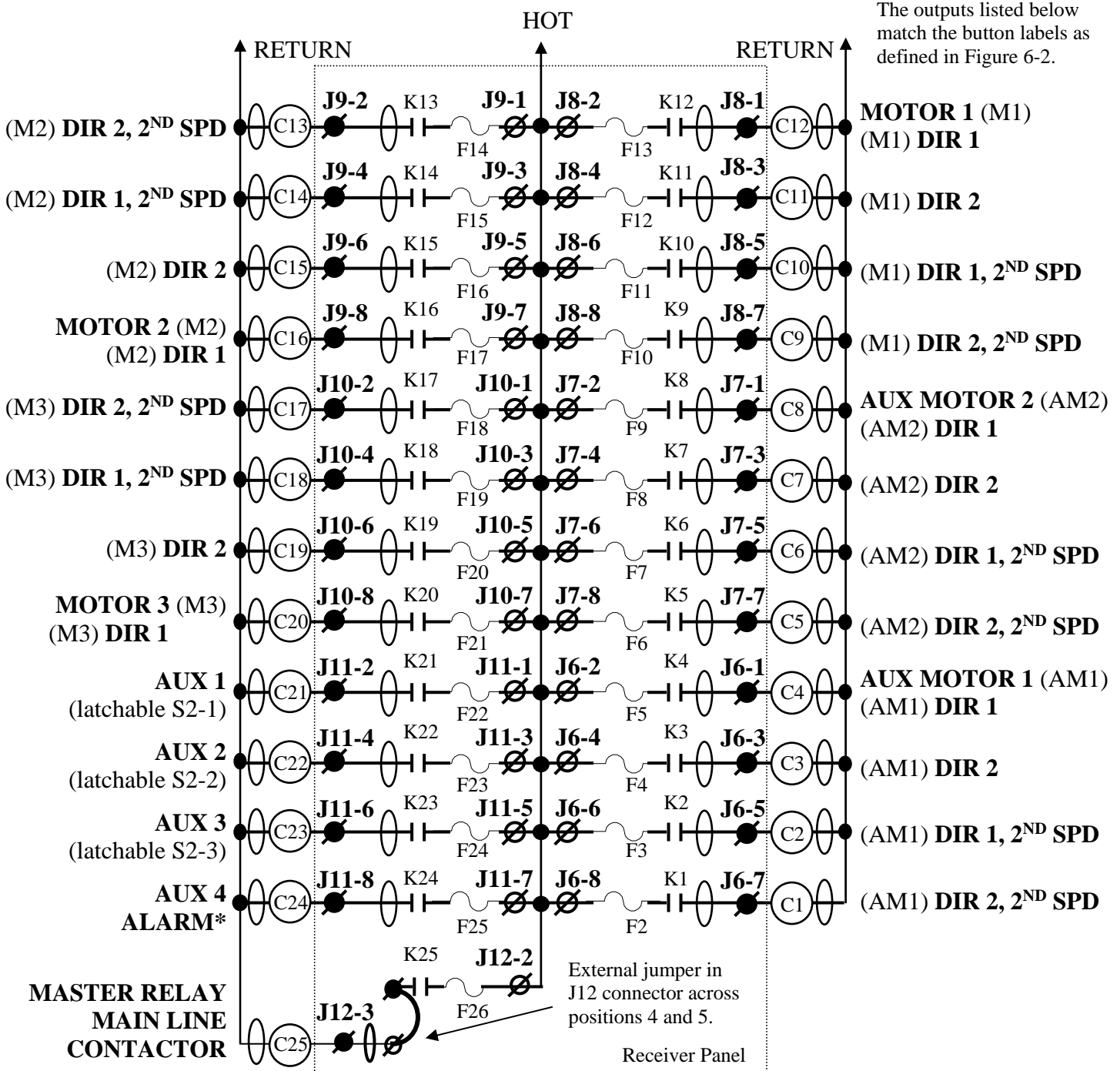

***Note:** Jumper JU1, Receiver Board for Alarm to function after an E-Stop command. See Figure 8-1.

Section 6 - Wiring (Continued)

TABLE 2(D) 2-SPEED WIRING DIAGRAM.

ACCO CONTROLS: ALL MOTIONS

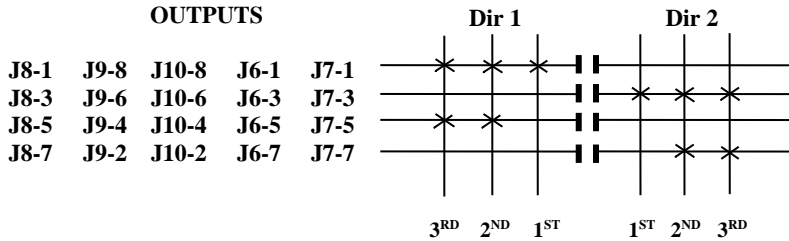

MOTOR 1 CONNECTIONS

- J8-1 *HOIST* UP
- J8-3 *HOIST* DOWN
- J8-5 *HOIST* UP 2ND SPD
- J8-7 *HOIST* DOWN 2ND SPD
- J8-1, 3, 5 & 7 HOT (J8-2, 4, 6 & 8)

MOTOR 2 CONNECTIONS

- J9-8 *TROLLEY* DIR 1
- J9-6 *TROLLEY* DIR 2
- J9-4 *TROLLEY* DIR 1, 2ND SPD
- J9-2 *TROLLEY* DIR 2, 2ND SPD
- J9-2, 4, 6 & 8 HOT (J9-1, 3, 5 & 7)

MOTOR 3 CONNECTIONS

- J10-8 *BRIDGE* DIR 1
- J10-6 *BRIDGE* DIR 2
- J10-4 *BRIDGE* DIR 1, 2ND SPD
- J10-2 *BRIDGE* DIR 2, 2ND SPD
- J10-2, 4, 6 & 8 HOT (J10-1, 3, 5 & 7)

AUX MOTOR 1 CONNECTIONS

- J6-1 *AUX HOIST* UP
- J6-3 *AUX HOIST* DOWN
- J6-5 *AUX UP HOIST* 2ND SPD
- J6-7 *AUX DOWN HOIST* 2ND SPD
- J6-1, 3, 5 & 7 HOT (J6-2, 4, 6 & 8)

AUX MOTOR 2 CONNECTIONS

- J7-1 *AUX TROLLEY* DIR 1
- J7-3 *AUX TROLLEY* DIR 2
- J7-5 *AUX TROLLEY* DIR 1, 2ND SPD
- J7-7 *AUX TROLLEY* DIR 2, 2ND SPD
- J7-1, 3, 5 & 7 HOT (J7-2, 4, 6 & 8)

INDEPENDENT OUTPUTS

- J11-2 *AUX 1* (LATCH S2-1) HOT J11-1
- J11-4 *AUX 2* (LATCH S2-2) HOT J11-3
- J11-6 *AUX 3* (LATCH S2-3) HOT J11-5
- J11-8 *AUX 4* (ALARM) HOT J11-7

RECEIVER And TRANSMITTER SWITCH SETTINGS

In the Receiver use the PDA Receiver Programmer to:

- Set “Receiver access code” and “Frequency”.
- In the “Receiver Programmer” screen, select under “System” “24 output”.
- In the “Set Status Words” screen, set RX and TX Status Word Switches S1 to S4 as shown below:

Xs are normally OFF (0) but may be turned ON (1) to enable additional features detailed in Section 7-11. Status Word Programming.

Switch #	Position							
	1	2	3	4	5	6	7	8
Rx S1	X	X	X	*0	1	X	X	X
Tx S3	X	X	X	0	1	1	0	0

Switch #	Position							
	1	2	3	4	5	6	7	8
Rx S2	X	X	X	0	0	0	X	X
Tx S4	0	0	0	0	0	0	0	0

In the transmitter:

- **3-Speed telePendant** use the PDA Transmitter Programmer to:
 - Set “Receiver access code” and “Frequency”. (Must be same as receiver).
 - Select under “Tx Type” “3 SPD telePendant”.
 - Select under “Motor” the number “5”.
- **MLTX, SLTX and JLTX**
 - In the table above, program Rx S1 position 4 ON (1).
 - In the transmitter turn switches SW3 “C” positions 1 through 7 and SW4 “D” positions 1 through 8 OFF. (SW3 “C” Position 8 ON disables the transmitter 15 minute time-out timer).

NOTE: *HOIST*, *TROLLEY* and *BRIDGE* are listed here as traditional configurations, the installer may choose to define the motors differently.

Section 6 - Wiring (Continued)

TABLE 2(E) DEMAG: 2-SPEED, 2-WINDINGS for HOIST and AUX HOIST; STANDARD 3-SPEED for TROLLEY, AUX TROLLEY and BRIDGE

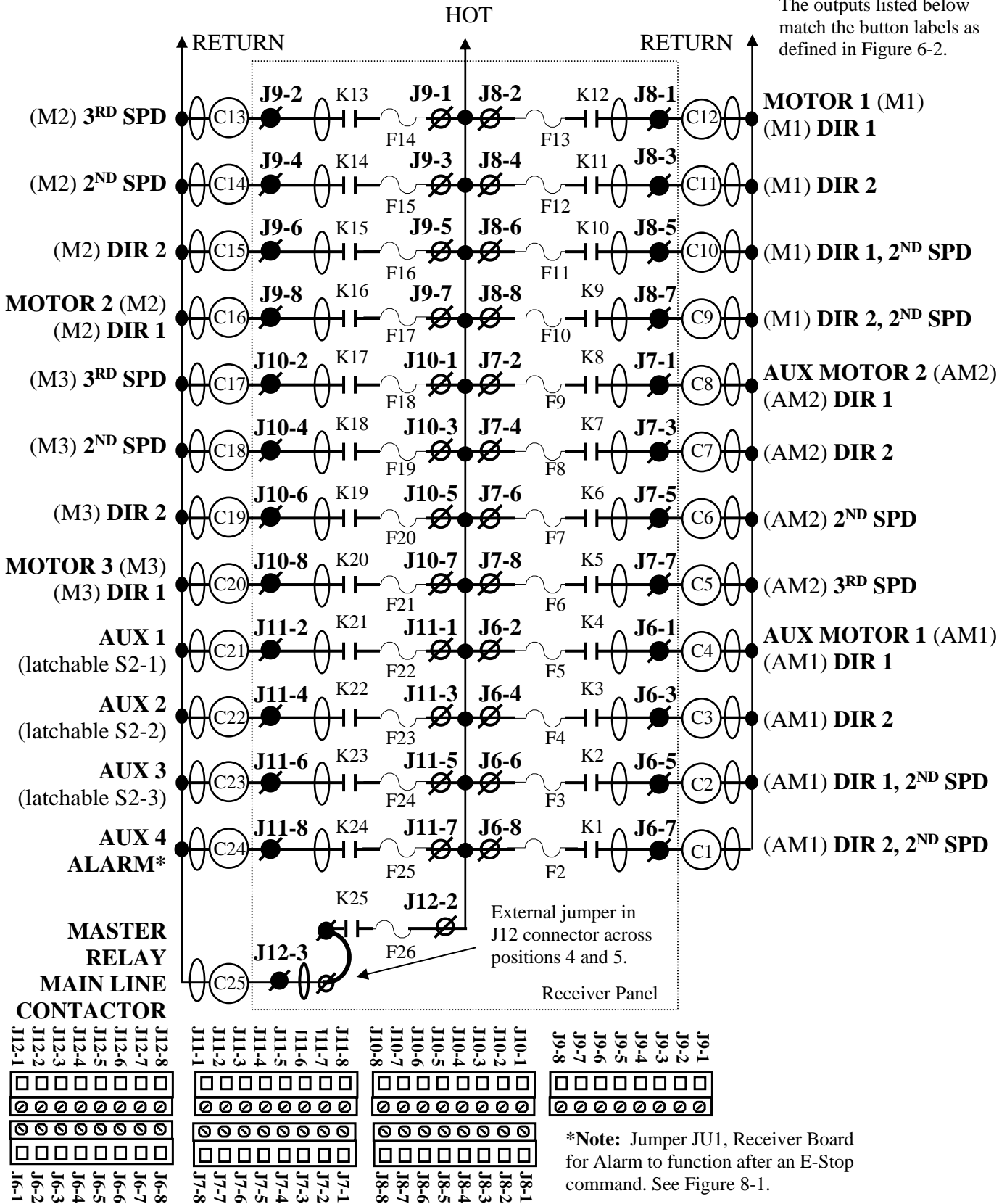

Section 6 - Wiring (Continued)

TABLE 2(E) DEMAG: 2-SPEED, 2-WINDINGS for HOIST and AUX HOIST; STANDARD 3-SPEED for TROLLEY, AUX TROLLEY and BRIDGE

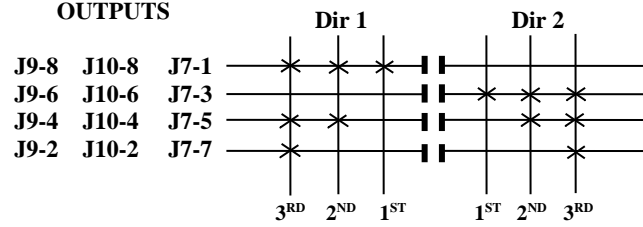
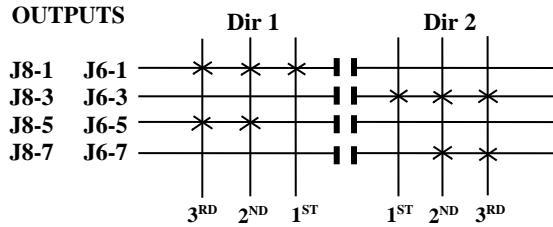

MOTOR 1 CONNECTIONS

- J8-1 *HOIST* UP
- J8-3 *HOIST* DOWN
- J8-5 *HOIST* 2ND SPEED
- J8-7 *HOIST* 2ND SPEED
- J8-1, 3, 5 & 7 HOT (J8-2, 4, 6 & 8)

MOTOR 2 CONNECTIONS

- J9-8 *TROLLEY* DIR 1
- J9-6 *TROLLEY* DIR 2
- J9-4 *TROLLEY* 2ND SPEED
- J9-2 *TROLLEY* 3RD SPEED
- J9-2, 4, 6 & 8 HOT (J9-1, 3, 5 & 7)

MOTOR 3 CONNECTIONS

- J10-8 *BRIDGE* DIR 1
- J10-6 *BRIDGE* DIR 2
- J10-4 *BRIDGE* 2ND SPEED
- J10-2 *BRIDGE* 3RD SPEED
- J10-2, 4, 6 & 8 HOT (J10-1, 3, 5 & 7)

AUX MOTOR 1 CONNECTIONS

- J6-1 *AUX HOIST* UP
- J6-3 *AUX HOIST* DOWN
- J6-5 *AUX HOIST* 2ND SPEED
- J6-7 *AUX HOIST* 2ND SPEED
- J6-1, 3, 5 & 7 HOT (J6-2, 4, 6 & 8)

AUX MOTOR 2 CONNECTIONS

- J7-1 *AUX TROLLEY* DIR 1
- J7-3 *AUX TROLLEY* DIR 2
- J7-5 *AUX TROLLEY* 2ND SPEED
- J7-7 *AUX TROLLEY* 3RD SPEED
- J7-1, 3, 5 & 7 HOT (J7-2, 4, 6 & 8)

INDEPENDENT OUTPUTS

- J11-2 AUX 1 (LATCH S2-1) HOT J11-1
- J11-4 AUX 2 (LATCH S2-2) HOT J11-3
- J11-6 AUX 3 (LATCH S2-3) HOT J11-5
- J11-8 AUX 4 (ALARM) HOT J11-7

RECEIVER And TRANSMITTER SWITCH SETTINGS

In the Receiver use the PDA Receiver Programmer to:

- Set “Receiver access code” and “Frequency”.
- In the “Receiver Programmer” screen, select under “System” “24 output”.
- In the “Set Status Words” screen, set RX and TX Status Word Switches S1 to S4 as shown below:

X’s are normally OFF (0) but may be turned ON (1) to enable additional features detailed in Section 7-11. Status Word Programming.

Switch #	Position							
	1	2	3	4	5	6	7	8
Rx S1	X	X	X	*0	1	X	X	X
Tx S3	X	X	X	0	0	0	1	0

Switch #	Position							
	1	2	3	4	5	6	7	8
Rx S2	X	X	X	0	0	0	X	X
Tx S4	0	0	0	0	0	0	0	0

In the transmitter:

- 3-Speed *telePendant* use the PDA Transmitter Programmer to:
 - Set “Receiver access code” and “Frequency”. (Must be same as receiver).
 - Select under “Tx Type” “3 SPD telePendant”.
 - Select under “Motor” the number “5”.
- MLTX, SLTX and JLTX
 - In the table above, program Rx S1 position 4 ON (1).
 - In the transmitter turn switches SW3 “C” positions 1 through 7 and SW4 “D” positions 1 through 8 OFF. (SW3 “C” Position 8 ON disables the transmitter 15 minute time-out timer).

NOTE: *HOIST*, *TROLLEY* and *BRIDGE* are listed here as traditional configurations, the installer may choose to define the motors differently.

Section 6 - Wiring (Continued)

TABLE 2(F) P & H: 2-SPEED, 2-WINDINGS for HOIST and AUX HOIST; STANDARD 3-SPEED for TROLLEY, AUX TROLLEY and BRIDGE

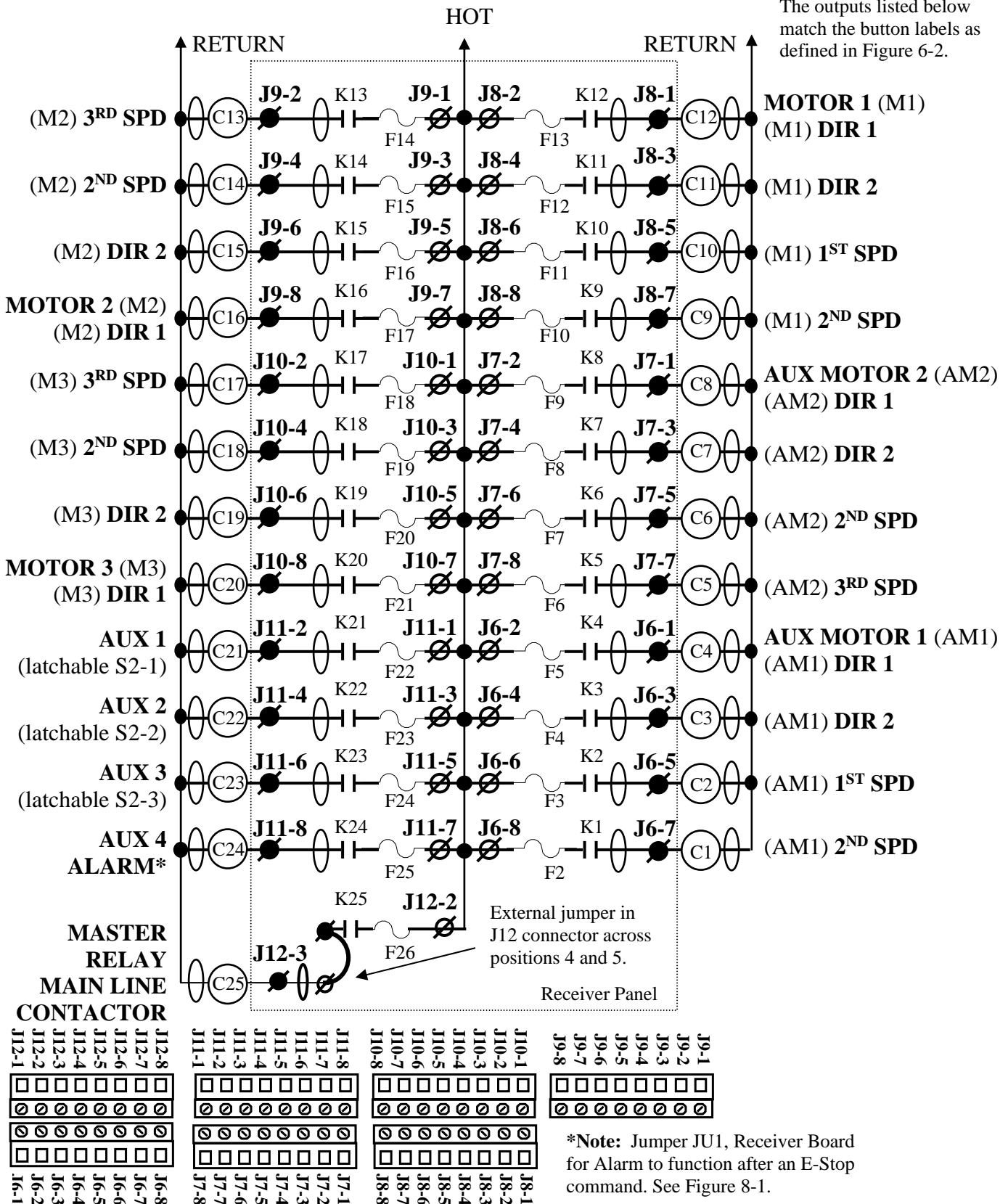

Section 6 - Wiring (Continued)

**TABLE 2(F) P & H: 2-SPEED, 2-WINDINGS for HOIST and AUX HOIST;
STANDARD 3-SPEED for TROLLEY, AUX TROLLEY and BRIDGE**

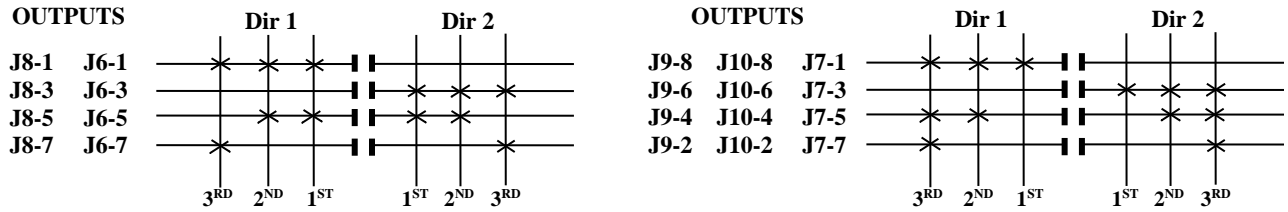

MOTOR 1 CONNECTIONS

- J8-1 *HOIST* UP
- J8-3 *HOIST* DOWN
- J8-5 *HOIST* 1ST SPEED
- J8-7 *HOIST* 2ND SPEED
- J8-1, 3, 5 & 7 HOT (J8-2, 4, 6 & 8)

MOTOR 2 CONNECTIONS

- J9-8 *TROLLEY* DIR 1
- J9-6 *TROLLEY* DIR 2
- J9-4 *TROLLEY* 2ND SPEED
- J9-2 *TROLLEY* 3RD SPEED
- J9-2, 4, 6 & 8 HOT (J9-1, 3, 5 & 7)

MOTOR 3 CONNECTIONS

- J10-8 *BRIDGE* DIR 1
- J10-6 *BRIDGE* DIR 2
- J10-4 *BRIDGE* 2ND SPEED
- J10-2 *BRIDGE* 3RD SPEED
- J10-2, 4, 6 & 8 HOT (J10-1, 3, 5 & 7)

AUX MOTOR 1 CONNECTIONS

- J6-1 *AUXST* UP
- J6-3 *AUX HOIST* DOWN
- J6-5 *AUX HOIST* 1ST SPEED
- J6-7 *AUX HOIST* 2ND SPEED
- J6-1, 3, 5 & 7 HOT (J6-2, 4, 6 & 8)

AUX MOTOR 2 CONNECTIONS

- J7-1 *AUX TROLLEY* DIR 1
- J7-3 *AUX TROLLEY* DIR 2
- J7-5 *AUX TROLLEY* 2ND SPEED
- J7-7 *AUX TROLLEY* 3RD SPEED
- J7-1, 3, 5 & 7 HOT (J7-2, 4, 6 & 8)

INDEPENDENT OUTPUTS

- J11-2 *AUX* 1 (LATCH S2-1) HOT J11-1
- J11-4 *AUX* 2 (LATCH S2-2) HOT J11-3
- J11-6 *AUX* 3 (LATCH S2-3) HOT J11-5
- J11-8 *AUX* 4 (ALARM) HOT J11-7

RECEIVER And TRANSMITTER SWITCH SETTINGS

In the Receiver use the PDA Receiver Programmer to:

- Set “Receiver access code” and “Frequency”.
- In the “Receiver Programmer” screen, select under “System” “24 output”.
- In the “Set Status Words” screen, set RX and TX Status Word Switches S1 to S4 as shown below:

X’s are normally OFF (0) but may be turned ON (1) to enable additional features detailed in Section 7-11. Status Word Programming.

Switch #	Position							
	1	2	3	4	5	6	7	8
Rx S1	X	X	X	*0	1	X	X	X
Tx S3	X	X	X	0	1	0	1	0

Switch #	Position							
	1	2	3	4	5	6	7	8
Rx S2	X	X	X	0	0	0	X	X
Tx S4	0	0	0	0	0	0	0	0

In the transmitter:

- 3-Speed *telePendant* use the PDA Transmitter Programmer to:
 - Set “Receiver access code” and “Frequency”. (Must be same as receiver).
 - Select under “Tx Type” “3 SPD telePendant”.
 - Select under “Motor” the number “5”.
- **MLTX, SLTX and JLTX**
 - In the table above, program Rx S1 position 4 ON (1).
 - In the transmitter turn switches SW3 “C” positions 1 through 7 and SW4 “D” positions 1 through 8 OFF. (SW3 “C” Position 8 ON disables the transmitter 15 minute time-out timer).

NOTE: *HOIST*, *TROLLEY* and *BRIDGE* are listed here as traditional configurations, the installer may choose to define the motors differently.

Section 6 - Wiring (Continued)

TABLE 2(G) P & H: 2-SPEED, 2-WINDINGS for HOIST, AUX HOIST, TROLLEY, and AUX TROLLEY; STANDARD 3-SPEED BRIDGE

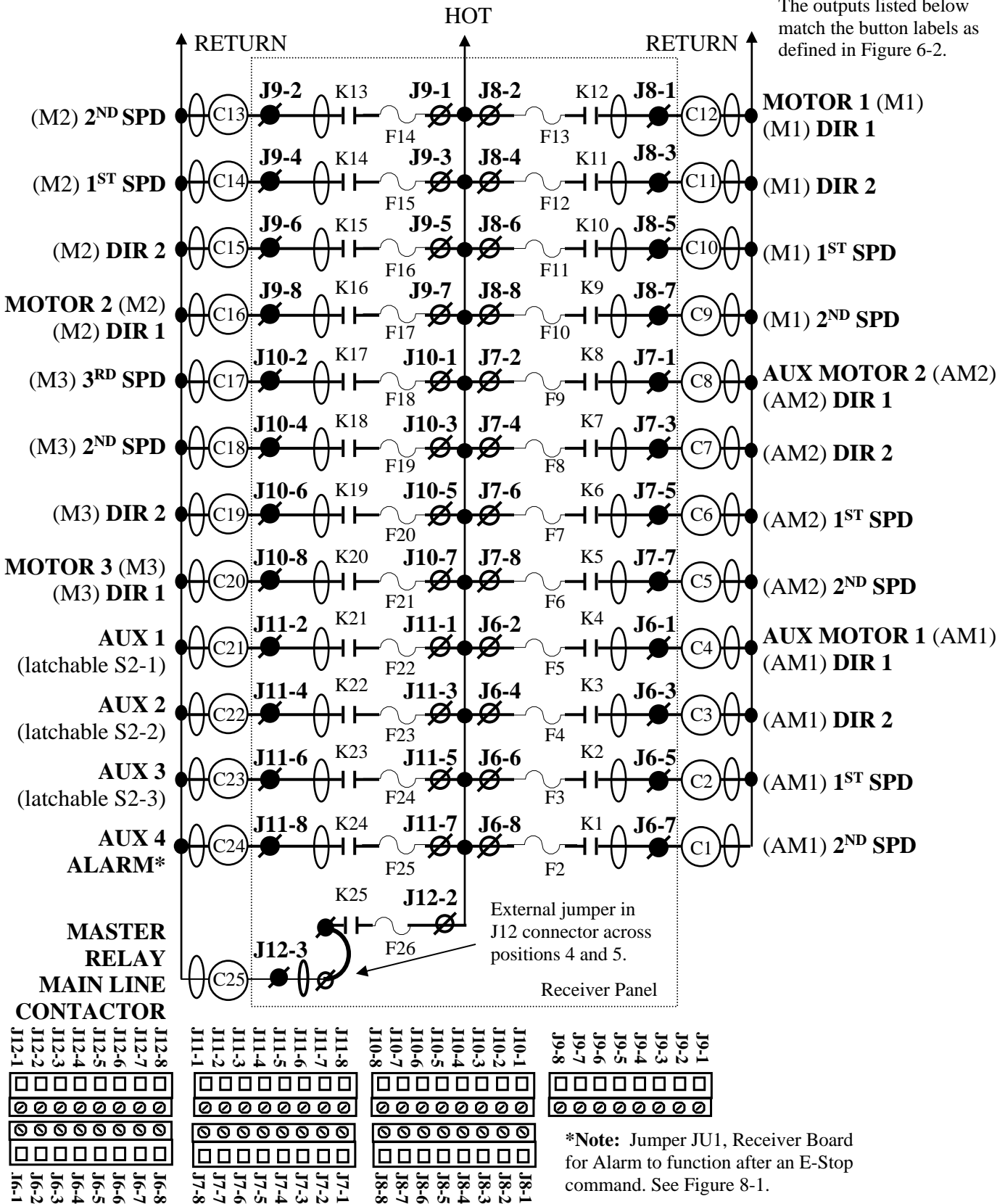

Section 6 - Wiring (Continued)

TABLE 2(G) P & H: 2-SPEED, 2-WINDINGS for HOIST, AUX HOIST, TROLLEY, and AUX TROLLEY; STANDARD 3-SPEED BRIDGE

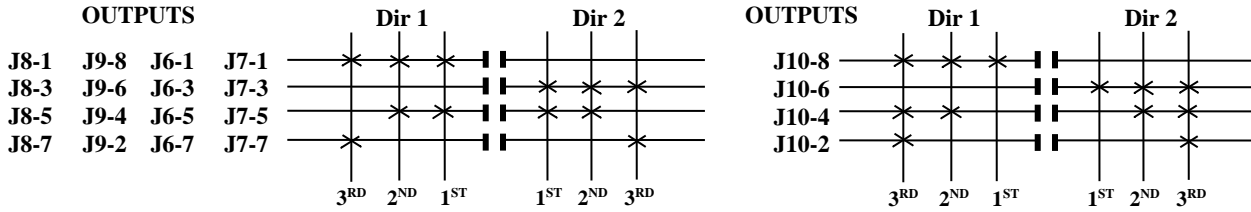

MOTOR 1 CONNECTIONS

- J8-1 *HOIST* UP
- J8-3 *HOIST* DOWN
- J8-5 *HOIST* 1ST SPEED
- J8-7 *HOIST* 2ND SPEED
- J8-1, 3, 5 & 7 HOT (J8-2, 4, 6 & 8)

MOTOR 2 CONNECTIONS

- J9-8 *TROLLEY* DIR 1
- J9-6 *TROLLEY* DIR 2
- J9-4 *TROLLEY* 1ST SPEED
- J9-2 *TROLLEY* 2ND SPEED
- J9-2, 4, 6 & 8 HOT (J9-1, 3, 5 & 7)

MOTOR 3 CONNECTIONS

- J10-8 *BRIDGE* DIR 1
- J10-6 *BRIDGE* DIR 2
- J10-4 *BRIDGE* 2ND SPEED
- J10-2 *BRIDGE* 3RD SPEED
- J10-2, 4, 6 & 8 HOT (J10-1, 3, 5 & 7)

AUX MOTOR 1 CONNECTIONS

- J6-1 *AUX HOIST* UP
- J6-3 *AUX HOIST* DOWN
- J6-5 *AUX HOIST* 1ST SPEED
- J6-7 *AUX HOIST* 2ND SPEED
- J6-1, 3, 5 & 7 HOT (J6-2, 4, 6 & 8)

AUX MOTOR 2 CONNECTIONS

- J7-1 *AUX TROLLEY* DIR 1
- J7-3 *AUX TROLLEY* DIR 2
- J7-5 *AUX TROLLEY* 1ST SPEED
- J7-7 *AUX TROLLEY* 2ND SPEED
- J7-1, 3, 5 & 7 HOT (J7-2, 4, 6 & 8)

INDEPENDENT OUTPUTS

- J11-2 AUX 1 (LATCH S2-1) HOT J11-1
- J11-4 AUX 2 (LATCH S2-2) HOT J11-3
- J11-6 AUX 3 (LATCH S2-3) HOT J11-5
- J11-8 AUX 4 (ALARM) HOT J11-7

RECEIVER And TRANSMITTER SWITCH SETTINGS

In the Receiver use the PDA Receiver Programmer to:

- Set “Receiver access code” and “Frequency”.
- In the “Receiver Programmer” screen, select under “System” “24 output”.
- In the “Set Status Words” screen, set RX and TX Status Word Switches S1 to S4 as shown below:

X’s are normally OFF (0) but may be turned ON (1) to enable additional features detailed in Section 7-11. Status Word Programming.

Switch #	Position							
	1	2	3	4	5	6	7	8
Rx S1	X	X	X	*0	1	X	X	X

Switch #	Position							
	1	2	3	4	5	6	7	8
Rx S2	X	X	X	0	0	0	X	X

Tx S3	X	X	X	0	0	1	1	0
-------	---	---	---	---	---	---	---	---

Tx S4	0	0	0	0	0	0	0	0
-------	---	---	---	---	---	---	---	---

In the transmitter:

- 3-Speed *telePendant* use the PDA Transmitter Programmer to:
 - Set “Receiver access code” and “Frequency”. (Must be same as receiver).
 - Select under “Tx Type” “3 SPD telePendant”.
 - Select under “Motor” the number “5”.
- MLTX, SLTX and JLTX
 - In the table above, program Rx S1 position 4 ON (1).
 - In the transmitter turn switches SW3 “C” positions 1 through 7 and SW4 “D” positions 1 through 8 OFF. (SW3 “C” Position 8 ON disables the transmitter 15 minute time-out timer).

NOTE: *HOIST*, *TROLLEY* and *BRIDGE* are listed here as traditional configurations, the installer may choose to define the motors differently.

Section 6 - Wiring (Continued)

TABLE 2(H) P & H: 2-SPEED, 2-WINDINGS for HOIST, TROLLEY, and AUX TROLLEY; with CREEP SPEED AUX HOIST; STANDARD 3-SPEED for BRIDGE

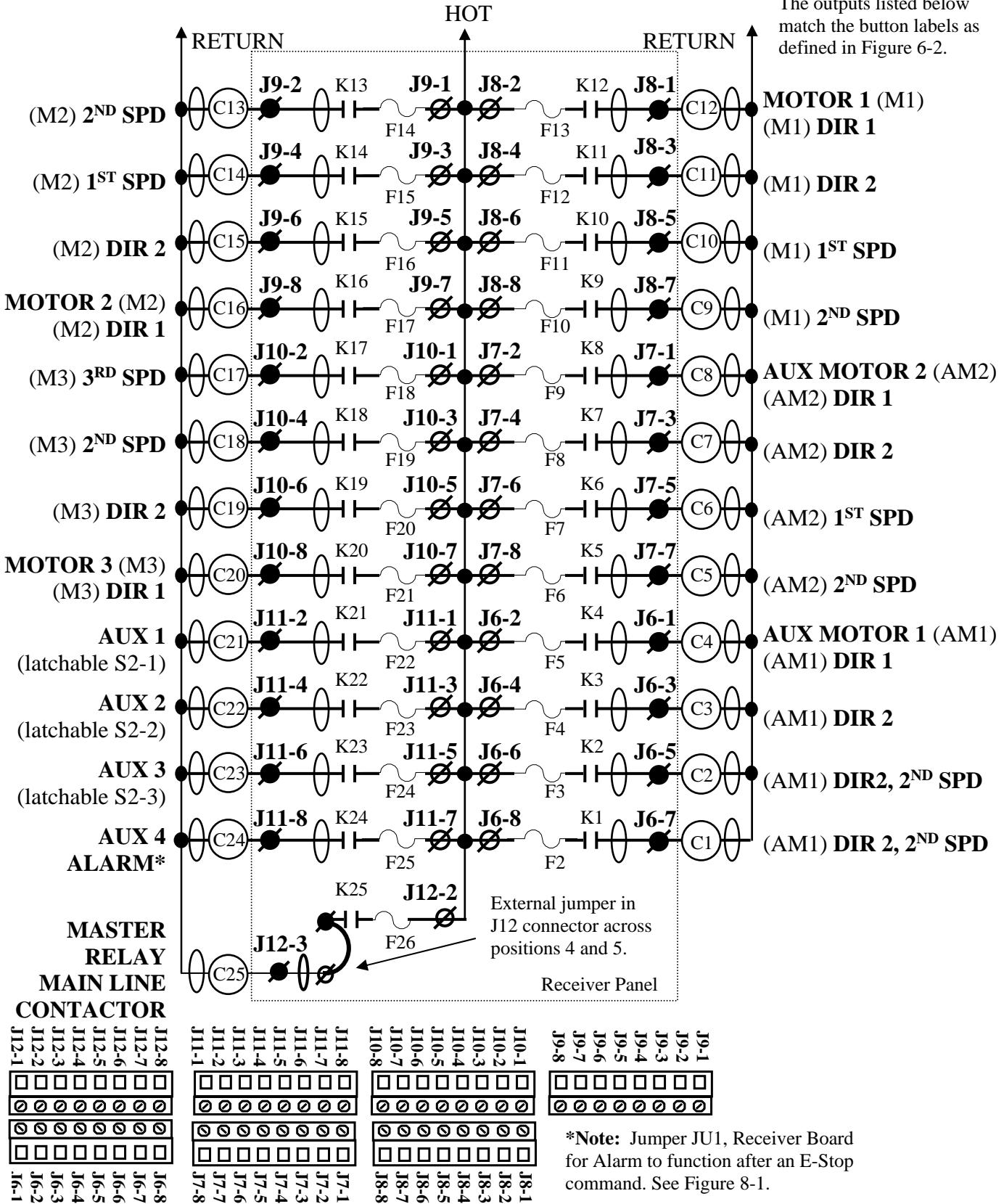

Section 6 - Wiring (Continued)

TABLE 2(H) P & H: 2-SPEED, 2-WINDINGS for HOIST, TROLLEY, and AUX TROLLEY; with CREEP SPEED AUX HOIST; STANDARD 3-SPEED for BRIDGE

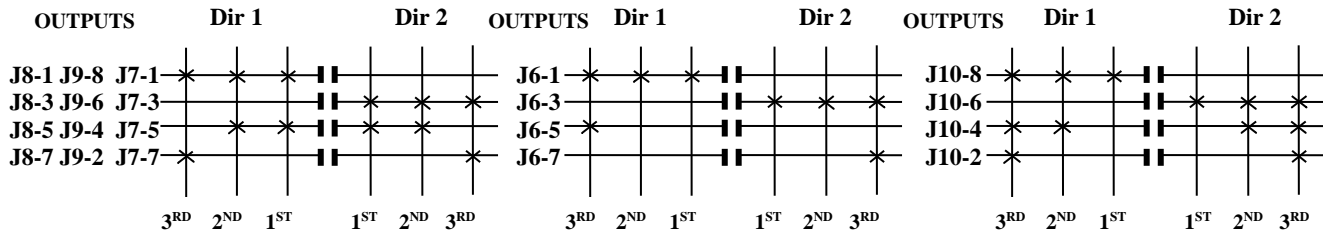

MOTOR 1 CONNECTIONS

- J8-1 *HOIST* UP
- J8-3 *HOIST* DOWN
- J8-5 *HOIST* 1ST SPEED
- J8-7 *HOIST* 2ND SPEED
- J8-1, 3, 5 & 7 HOT (J8-2, 4, 6 & 8)

MOTOR 2 CONNECTIONS

- J9-8 *TROLLEY* DIR 1
- J9-6 *TROLLEY* DIR 2
- J9-4 *TROLLEY* 1ST SPEED
- J9-2 *TROLLEY* 2ND SPEED
- J9-2, 4, 6 & 8 HOT (J9-1, 3, 5 & 7)

MOTOR 3 CONNECTIONS

- J10-8 *BRIDGE* DIR 1
- J10-6 *BRIDGE* DIR 2
- J10-4 *BRIDGE* 2ND SPEED
- J10-2 *BRIDGE* 3RD SPEED
- J10-2, 4, 6 & 8 HOT (J10-1, 3, 5 & 7)

AUX MOTOR 1 CONNECTIONS

- J6-1 *AUX HOIST* UP
- J6-3 *AUX HOIST* DOWN
- J6-5 *AUX HOIST* UP 2ND SPEED
- J6-7 *AUX HOIST* DOWN 2ND SPEED
- J6-1, 3, 5 & 7 HOT (J6-2, 4, 6 & 8)

AUX MOTOR 2 CONNECTIONS

- J7-1 *AUX TROLLEY* DIR 1
- J7-3 *AUX TROLLEY* DIR 2
- J7-5 *AUX TROLLEY* 1ST SPEED
- J7-7 *AUX TROLLEY* 2ND SPEED
- J7-1, 3, 5 & 7 HOT (J7-2, 4, 6 & 8)

INDEPENDENT OUTPUTS

- J11-2 *AUX 1 (LATCH S2-1) HOT* J11-1
- J11-4 *AUX 2 (LATCH S2-2) HOT* J11-3
- J11-6 *AUX 3 (LATCH S2-3) HOT* J11-5
- J11-8 *AUX 4 (ALARM) HOT* J11-7

RECEIVER And TRANSMITTER SWITCH SETTINGS

In the Receiver use the PDA Receiver Programmer to:

- Set “Receiver access code” and “Frequency”.
- In the “Receiver Programmer” screen, select under “System” “24 output”.
- In the “Set Status Words” screen, set RX and TX Status Word Switches S1 to S4 as shown below:

X’s are normally OFF (0) but may be turned ON (1) to enable additional features detailed in Section 7-11. Status Word Programming.

Switch #	Position							
	1	2	3	4	5	6	7	8
Rx S1	X	X	X	*0	1	X	X	X

Switch #	Position							
	1	2	3	4	5	6	7	8
Rx S2	X	X	X	0	0	0	X	X

Tx S3	X	X	X	0	1	1	1	0
-------	---	---	---	---	---	---	---	---

Tx S4	0	0	0	0	0	0	0	0
-------	---	---	---	---	---	---	---	---

In the transmitter:

- 3-Speed *telePendant* use the PDA Transmitter Programmer to:
 - Set “Receiver access code” and “Frequency”. (Must be same as receiver).
 - Select under “Tx Type” “3 SPD telePendant”.
 - Select under “Motor” the number “5”.
- **MLTX, SLTX and JLTX**
 - In the table above, program Rx S1 position 4 ON (1).
 - In the transmitter turn switches SW3 “C” positions 1 through 7 and SW4 “D” positions 1 through 8 OFF. (SW3 “C” Position 8 ON disables the transmitter 15 minute time-out timer).

NOTE: *HOIST*, *TROLLEY* and *BRIDGE* are listed here as traditional configurations, the installer may choose to define the motors differently.

Section 6 - Wiring (Continued)

TABLE 2(I) P & H: 2-SPEED, 2-WINDINGS for HOIST, TROLLEY, and AUX TROLLEY; with CREEP SPEED AUX HOIST; STANDARD 3-SPEED for BRIDGE

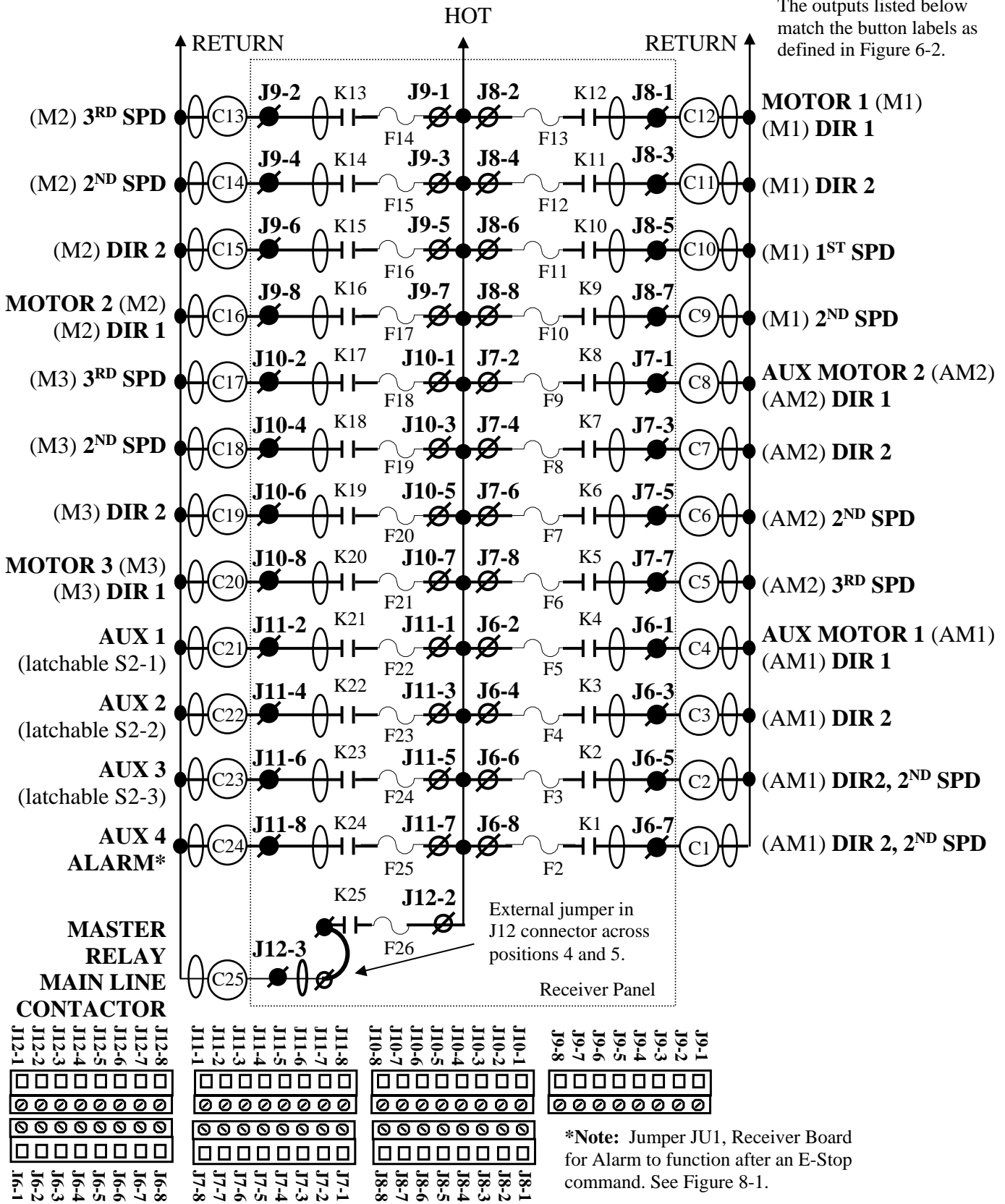

Section 6 - Wiring (Continued)

**TABLE 2(I) P & H: 2-SPEED, 2-WINDINGS for HOIST, TROLLEY, and AUX TROLLEY;
with CREEP SPEED AUX HOIST; STANDARD 3-SPEED for BRIDGE**

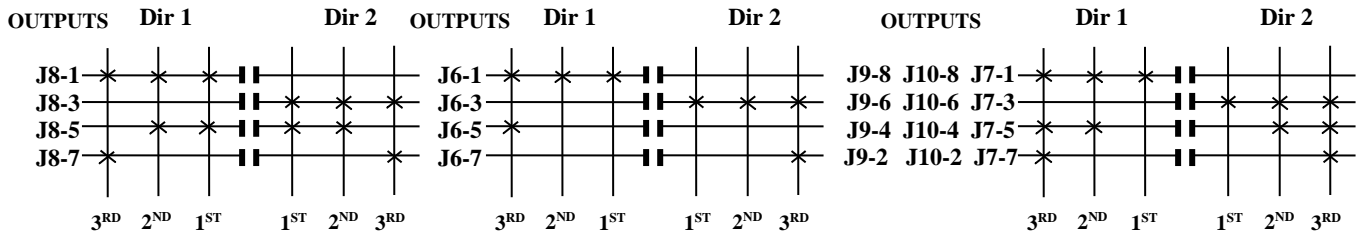

MOTOR 1 CONNECTIONS

- J8-1 *HOIST* UP
- J8-3 *HOIST* DOWN
- J8-5 *HOIST* 1ST SPEED
- J8-7 *HOIST* 2ND SPEED
- J8-1, 3, 5 & 7 HOT (J8-2, 4, 6 & 8)

MOTOR 2 CONNECTIONS

- J9-8 *TROLLEY* DIR 1
- J9-6 *TROLLEY* DIR 2
- J9-4 *TROLLEY* 2ND SPEED
- J9-2 *TROLLEY* 3RD SPEED
- J9-2, 4, 6 & 8 HOT (J9-1, 3, 5 & 7)

MOTOR 3 CONNECTIONS

- J10-8 *BRIDGE* DIR 1
- J10-6 *BRIDGE* DIR 2
- J10-4 *BRIDGE* 2ND SPEED
- J10-2 *BRIDGE* 3RD SPEED
- J10-2, 4, 6 & 8 HOT (J10-1, 3, 5 & 7)

AUX MOTOR 1 CONNECTIONS

- J6-1 *AUX HOIST* UP
- J6-3 *AUX HOIST* DOWN
- J6-5 *AUX HOIST* UP 2ND SPEED
- J6-7 *AUX HOIST* DOWN 2ND SPEED
- J6-1, 3, 5 & 7 HOT (J6-2, 4, 6 & 8)

AUX MOTOR 2 CONNECTIONS

- J7-1 *AUX TROLLEY* DIR 1
- J7-3 *AUX TROLLEY* DIR 2
- J7-5 *AUX TROLLEY* 1ST SPEED
- J7-7 *AUX TROLLEY* 2ND SPEED
- J7-1, 3, 5 & 7 HOT (J7-2, 4, 6 & 8)

INDEPENDENT OUTPUTS

- J11-2 AUX 1 (LATCH S2-1) HOT J11-1
- J11-4 AUX 2 (LATCH S2-2) HOT J11-3
- J11-6 AUX 3 (LATCH S2-3) HOT J11-5
- J11-8 AUX 4 (ALARM) HOT J11-7

RECEIVER And TRANSMITTER SWITCH SETTINGS

In the Receiver use the PDA Receiver Programmer to:

- Set “Receiver access code” and “Frequency”.
- In the “Receiver Programmer” screen, select under “System” “24 output”.
- In the “Set Status Words” screen, set RX and TX Status Word Switches S1 to S4 as shown below:

X’s are normally OFF (0) but may be turned ON (1) to enable additional features detailed in Section 7-11. Status Word Programming.

Switch #	Position							
	1	2	3	4	5	6	7	8
Rx S1	X	X	X	*0	1	X	X	X

Switch #	Position							
	1	2	3	4	5	6	7	8
Rx S2	X	X	X	0	0	0	X	X

Tx S3	X	X	X	0	0	0	0	1
--------------	---	---	---	---	---	---	---	---

Tx S4	0	0	0	0	0	0	0	0
--------------	---	---	---	---	---	---	---	---

In the transmitter:

- 3-Speed *telePendant* use the PDA Transmitter Programmer to:
 - Set “Receiver access code” and “Frequency”. (Must be same as receiver).
 - Select under “Tx Type” “3 SPD telePendant”.
 - Select under “Motor” the number “5”.
- **MLTX, SLTX and JLTX**
 - In the table above, program Rx S1 position 4 ON (1).
 - In the transmitter turn switches SW3 “C” positions 1 through 7 and SW4 “D” positions 1 through 8 OFF. (SW3 “C” Position 8 ON disables the transmitter 15 minute time-out timer).

NOTE: *HOIST*, *TROLLEY* and *BRIDGE* are listed here as traditional configurations, the installer may choose to define the motors differently.

Section 6 - Wiring (Continued)

TABLE 2(J) STANDARD 5-SPEED for 5 SPEED LEVER SWITCH TRANSMITTER

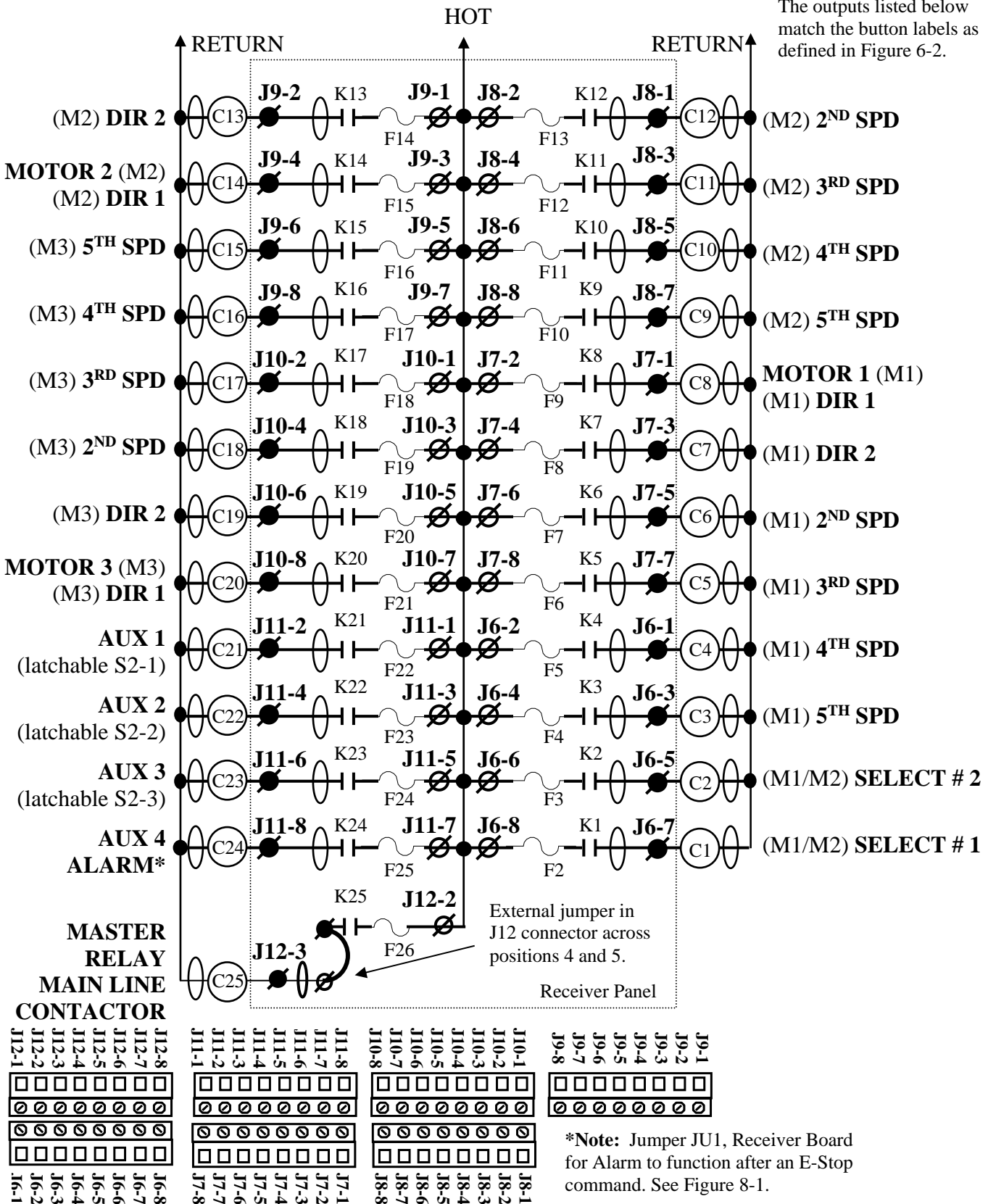

Section 6 - Wiring (Continued)

TABLE 2(J) STANDARD 5-SPEED for 5 SPEED LEVER SWITCH TRANSMITTER

MOTOR 1					OFF	MOTOR 1					OUTPUT TERMINAL	MOTOR 2					OFF	MOTOR 2					OUTPUT TERMINAL	MOTOR 3					OFF	MOTOR 3					OUTPUT TERMINAL		
DIR 1						DIR 2							DIR 1						DIR 2						DIR 1						DIR 2						
X	X	X	X	X							J7-1	X	X	X	X	X							J9-4	X	X	X	X	X							J10-8		
					X	X	X	X	X	X	J7-3						X	X	X	X	X						X	X	X	X							J10-6
X	X	X	X			X	X	X	X	X	J7-5	X	X	X	X		X	X	X	X							X	X	X	X							J10-4
X	X	X					X	X	X		J7-7	X	X	X				X	X	X		X	X	X				X	X	X							J10-2
X	X								X	X	J6-1	X	X					X	X			X	X					X	X							J9-8	
X										X	J6-3	X									X	X							X							J9-6	

MOTOR 1 CONNECTIONS

- J7-1 HOIST UP
- J7-3 HOIST DOWN
- J7-5 HOIST 2ND SPEED
- J7-7 HOIST 3RD SPEED
- J6-1 HOIST 4TH SPEED
- J6-3 HOIST 5TH SPEED
- J7-1, 3, 5 & 7 HOT (J7-2, 4, 6 & 8)
- J6-1 & 3 HOT (J6-2 & 4)

MOTOR 2 CONNECTIONS

- J9-4 TROLLEY DIR 1
- J9-2 TROLLEY DIR 2
- J8-1 TROLLEY 2ND SPEED
- J8-3 TROLLEY 3RD SPEED
- J8-5 TROLLEY 4TH SPEED
- J8-7 TROLLEY 5TH SPEED
- J9-2 & 4 HOT (J9-1 & 3)
- J8-1, 3, 5 & 7 HOT (J8-2, 4, 6 & 8)

MOTOR 3 CONNECTIONS

- J10-8 BRIDGE DIR 1
- J10-6 BRIDGE DIR 2
- J10-4 BRIDGE 2ND SPEED
- J10-2 BRIDGE 3RD SPEED
- J9-8 BRIDGE 4TH SPEED
- J9-6 BRIDGE 5TH SPEED
- J10-2, 4, 6 & 8 HOT (J10-1, 3, 5 & 7)
- J9-6 & 8 HOT (J9-5 & 7)

INDEPENDENT OUTPUTS

- J11-2 AUX 1 (LATCH S2-1) HOT J11-1
- J11-4 AUX 2 (LATCH S2-2) HOT J11-3
- J11-6 AUX 3 (LATCH S2-3) HOT J11-5
- J11-8 AUX 4 (ALARM) HOT J11-7

RECEIVER And TRANSMITTER SWITCH SETTINGS

In the Receiver use the PDA Receiver Programmer to:

- Set “Receiver access code” and “Frequency” frequency must match the transmitter.
- In the “Receiver Programmer” screen, select under “System” “24 output”.
- In the “Set Status Words” screen, set RX and TX Status Word Switches S1 to S4 as shown below:

X’s are normally OFF (0) but may be turned ON (1) to enable additional features detailed in Section 7-11. Status Word Programming.

Switch #	Position							
	1	2	3	4	5	6	7	8
Rx S1	X	X	X	1	1	X	X	X
Tx S3	X	X	X	0	0	0	0	0

Switch #	Position							
	1	2	3	4	5	6	7	8
Rx S2	X	X	X	0	0	0	X	X
Tx S4	0	0	0	0	0	0	1	0

In the transmitter:

- MLTX, SLTX and JLTX
 - In the transmitter turn switches SW3 “C” positions 1 through 7 and SW4 “D” positions 1 through 8 OFF. (SW3 “C” Position 8 ON disables the transmitter 15 minute time-out timer).

NOTE: HOIST, TROLLEY and BRIDGE are listed here as traditional configurations, the installer may choose to define the motors differently.

Section 7 - Programming

7-1. Receiver Programming Overview.

Historically in Telemotive's 10K systems the user had to program the transmitter for frequency, access code plus all number of additional parameters for a special crane application. Special relay configurations were programmed in the transmitter for different types of crane motor, i.e., ACCO, Demag etc. Now with *inteleSmart* receiver these features only have to be programmed in the receiver once so that a basic configured transmitter (frequency, access code and number of motors) can properly operate any crane configuration. Also with *inteleSmart* the receiver's configurations are easily configured using a PDA.

Read the descriptions below to familiarize yourself with the *inteleSmart* features. The *inteleSmart* receiver unit for programming uses a PDA (Personal Digital Assistant). Such products as Palm Pilot® or many other products using Palm OS® 4.X or lower can be used to run the programming software. If you don't know if your PDA will work or for a recommended product contact Telemotive. The software for the PDA is available on a disk shipped with your unit, or it can be emailed from your Telemotive representative.

inteleSmart PDA software is quite user friendly and is intended to mimic the dip switch settings used in other Telemotive products without the inconvenience of having to open the case. The PDA software allows you to select frequency, access code, time-out-timer settings, switch arrangement and crane configuration as in other Telemotive transmitter products.

7-2. Programmer Setup.

Load the *inteleSmart* programming software into your PDA, refer to your PDA manual or contact Telemotive for the appropriate procedure. Once loaded, look for the Telemotive circle and hook logo labeled "Receiver" for the appropriate application. Select this application to begin programming.



Receiver

With the programmer you can load:

- System type
- Frequency
- Access Codes
- Key arrangement
- Relay configuration
- Tandem disable
- Invert crane select
- Time-out-timer time
- Mode selection
- Alarm settings

Section 7 - Programming (Continued)

7-3. Receiver Programming.

The *inteleSmart* receiver comes preprogrammed. Additional programming is not normally needed. After loading and opening the *inteleSmart* program the first screen is the initial setup screen. See Figure 7-1. Receiver Programming Screen.

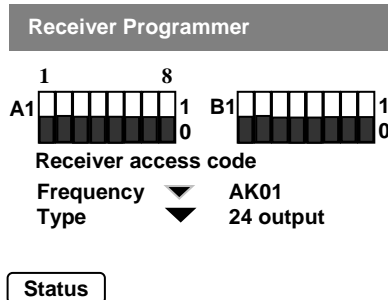

Figure 7-1. Receiver Programming Screen

7-4. Downloading Parameters from an *inteleSmart* receiver.

To read current programming, tap with a stylus on the word “Receiver” at the top of the screen. The top of the screen will change and the words “Record” and “Comm” will be shown. Tap on the word “Comm” to show the menu in Figure 7-2. Comm Menu. Turn the receiver OFF using switch S1. (See Figure 8-1. Receiver Board Layout for location). Aim the IR port on the PDA at the upper left hand corner of the receiver, turn the receiver ON using switch S1 and within 10 seconds then tap the word “Receive Setting”. An acknowledgement message will be displayed confirming status down loading.

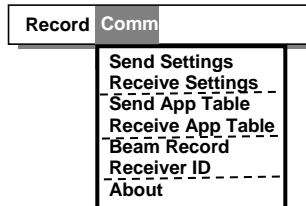

Figure 7-2. Comm Menu.

NOTE

THE RECEIVER IS IN THE PROGRAMMING MODE FOR ABOUT 10 SECONDS AFTER CYCLING THE POWER SWITCH. DURING THIS TIME LED DS13, GREEN, WILL BE ON SOLID AND LED DS15, RED, WILL FLASH. IF THE UNIT IS NOT PROGRAMMED OR DATA READ DURING THIS TIME THE POWER MUST BE RECYCLED TO RE-ENTER THE PROGRAMMING MODE.

This information can now be saved using the menu under the word “Record”. This menu allows you to create new files, open existing files, delete files, save files and rename existing files. See Figure 7-3. Settings Menu.

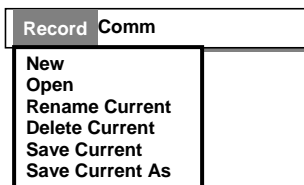

Figure 7-3. Settings Menu.

Section 7 - programming (Continued)

7-5. Saving Settings.

If the settings need to be changed, check the appropriate boxes for the changes, save the file and send it to the receiver using the same procedure as was used to download the settings, only on the PDA tap the command “Send Setting” instead of “Receive Setting”. Remember to cycle the ON/OFF switch S1 on the Receiver to put the unit in the programming mode.

7-6. Programming Frequency.

Select a Frequency (Must be inputted and match the respective transmitter for system to work):

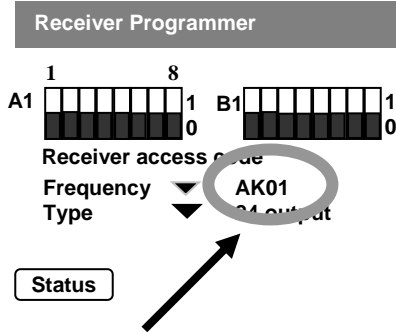

Figure 7-4. Frequency Selection.

There should be a label either on the receiver or the transmitter being replaced listing frequency, it should be a channel number between AK01 to AK20. Find this number and tap the “Freq” arrow and select that channel number.

For more details on receiver frequencies, reading or programming them without a PDA see Section 7-13.

Section 7 - Programming (Continued)

7-7. Programming Access Code.

Enter the Access Code (Must be inputted and match the respective transmitter for system to work):

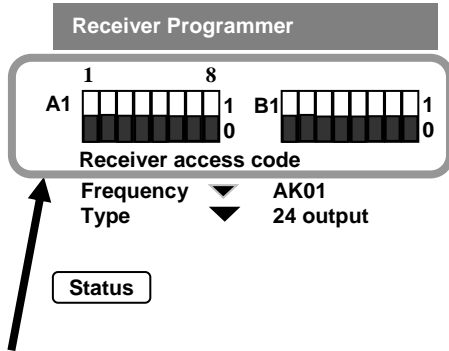

Figure 7-5. Access Code Input.

The access code is a unique string of sixteen 1s and 0s. The screen switches are labeled from left to right “A”, and “B”. They are numbered from left to right 1 to 8. The darkened rectangle to the bottom is “OFF” or “0”. The darkened rectangle to the top is “ON” or a “1”. Tapping the lightened rectangle will cause the switch to toggle.

See Section 7-13. Access Codes for important details on access code programming. There should be a label either on the receiver or the old transmitter showing the access code, it should be numbered A1 through A8 and B1 though B8. Find this number and tap the respective switches on the screen. If you cannot find a label with access code information, copy directly from the access code dip switches in your transmitter or receiver, being careful to match the designation and switch position as they do vary from model to model.

7-8. Programming a Receiver Type. (This must be correctly inputted for the System to work properly).

The receiver is determined by the number of outputs 12, 16 and 24. This receiver has 24 outputs. Select the “Type” “24 output”.

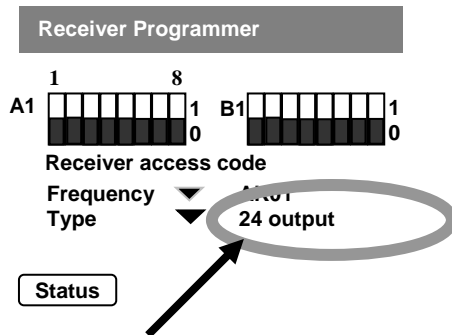

Figure 7-6. Receiver Type Selection.

Section 7 - programming (Continued)

7-9. Programming Receiver Status Word.

The following parameters listed below are controlled by this screen. If none of this needs to be changed from the defaults, skip this screen and go directly to Section 7-10. Loading The Program.

Function	Default
Custom crane configurations	3-Speed Standard <i>tele</i> Pendant <i>See Section 6 - Wiring Table 2(A)</i>
Transmitter button position	Hoist, Trolley, Bridge
Receiver time-out time	15 Minutes
Latching Aux. relays	None
Special alarm settings	None
Group Code (Multiple Tx's)	Off
Active ESTOP	Off
Tandem disable	Off
Invert crane select	Off

By tapping on the word "Status" in the lower left hand corner the "Set Status Word" screen is displayed. See Figure 7-7. Status Button.

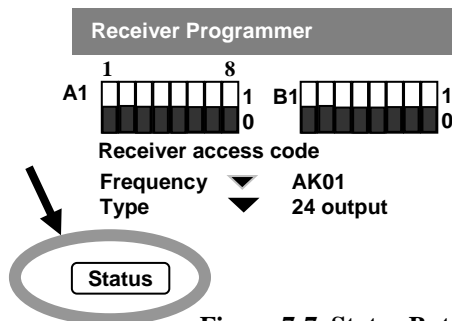

Figure 7-7. Status Button.

With the "Status" button selected the "Set Status Word" screen is displayed. See Figure 7-8. Set Status Word Screen on the next page and the details instructions for each function on the following pages. (See Section 7-11. Status Word Programming). When done setting the Status Word parameters tap the "Save" button to return to "Receiver Programmer" screen and go to step 7-10. below.

7-10. Loading The Program.

When done entering all the parameters on the PDA, save the program on the PDA. Cycle the power to the *inteleSmart* receiver (switch SW1). Within the first 10 seconds of the receiver turning ON, the LEDs DS13, green, will turn ON and DS15, red, will flash. Point the PDA at the receiver's IR port (see Figure 8-1. Receiver Layout for locations) and tap "Send Setting" under the Comm menu on the PDA. The Frequency, Access Code and type will be downloaded. DS14 will turn ON indicating the program was successfully downloaded. If DS13 turns OFF before downloading, recycle the power switch SW1.

Section 7 - programming (Continued)

Figure 7-8. Set Status Word Screen.

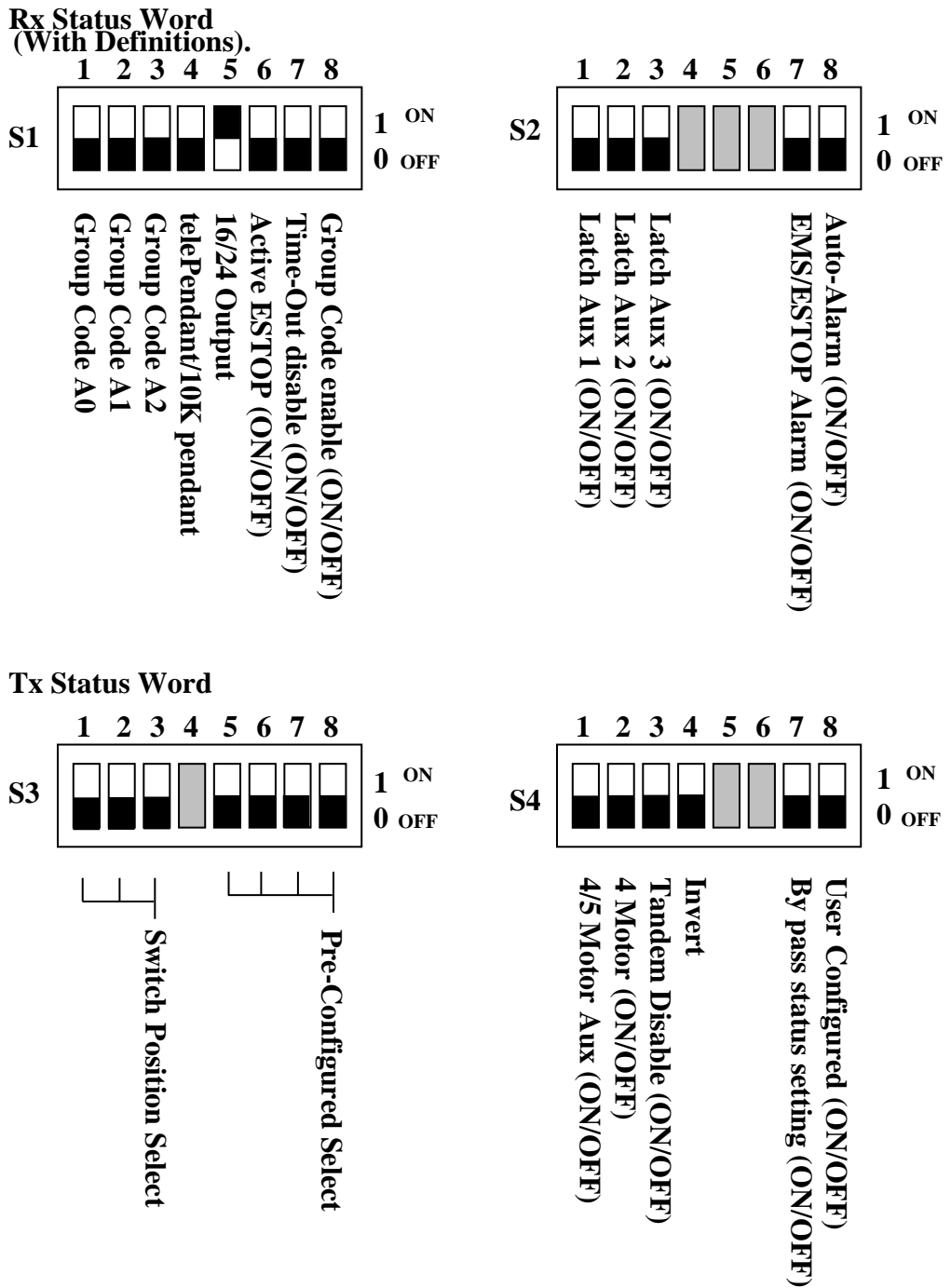

Set Status Word Screen with definitions shown. Definitions appear on the PDA on a single line below all the switches for a respective switch position when that position is toggled.

= Not used

Definitions and programming details follow in Section 7-11. Status Word Programming.

Section 7 - Programming (Continued)

7-11. Status Word Programming.

7-11.1. RX Status Word S1- 1, -2, -3 and -8. (Group Code).

GROUP CODE DIFFERS FROM MULTIBOX IN THAT THE ACCESS CODES DO NOT HAVE TO BE SEQUENTIAL.

Definition: Group Code capability allows up to 8 transmitters to access a single receiver on a first come first served basis. Only one transmitter may control the receiver at a given time. Once a transmitter has gained control, another transmitter may not access the receiver until the controlling transmitter relinquishes control by transmitting an OFF command to the receiver or the receiver times out due to inactivity.



WARNING

IF YOU NEED TO ADD GROUP CODE OR ADD ADDITIONAL TRANSMITTERS PLEASE CONTACT TELEMOTIVE FOR ASSISTANCE WITH THIS FEATURE. FAILURE TO FOLLOW THIS WARNING COULD RESULT IN SERIOUS INJURY OR DEATH AND DAMAGE TO EQUIPMENT.

7-11.2. Programming Group Code.

PDA switch settings programmed into the Receiver Board control turn ON Group Code and control the number of transmitters. Rx Status Word Switch S1 switch position for 1, 2 and 3 controls the number of transmitters from 1 up to 8. See Table 7-1. Group Code Switch Settings for proper Group Code settings.

Table 7-1. Group Code Switch Settings.

Maximum of Transmitters	Rx Status Word S1 Switch Settings		
	S1-1	S1-2	S1-3
1	0	0	0
2	1	0	0
3	0	1	0
4	1	1	0
5	0	0	1
6	1	0	1
7	0	1	1
8	1	1	1

Group Code Programming Step 1.

Go to the “Set Status Word” screen by tapping the box marked “Status” on the main “Receiver Programmer” screen. Turn RX Status Word switch S1 position 8 ON (1). Rx Status Word Switch S1 position 8 turns Group Code ON.

Group Code Programming Step 2.

Look at the Table 7-1. below and select the number of transmitters desired. Program this number into RX Status Word switch S1 positions 1, 2 and 3 per Table 7-1. Tap the “Save” button on the lower right hand corner of the “Set Status Word” screen.

Group Code Programming Step 3.

Select a separate and independent access code for each of the transmitters to be used on this receiver. **Make sure no Access Codes are duplicates of another system.** Contact Telemotive if you need assistance in picking Access Codes.

Section 7 - programming (Continued)

Group Code Programming Step 4.

In the “Receiver Programmer” screen there will be a set of boxes numbered with the number of transmitters desired below the words “Receiver access code”, as shown in Figure 7-10.

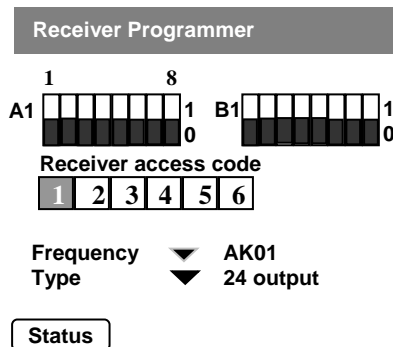

Figure 7-10. Receiver Programmer Screen with Group Code Enabled for 6 Transmitters.

(Rx Status Word S1 positions 8, 1 and 3 turned ON).

Sequentially tap each transmitter box and enter the respective transmitter Access Codes. Make sure all boxes are programmed. Make sure all transmitters and the receiver are programmed for the same frequency.

Group Code Programming Step 5.

Save the PDA settings and load the settings into the receiver and test each transmitter separately.

Section 7 - Programming (Continued)

7-11.3. Rx Status Word S1-4 (telePendant or 10K Pendant Operation). Normally OFF (0) for telePendant operation.

Definition: This is **only** used for **3-Speed** receiver applications to allow a JLTX, SLTX or older style 10K 3-Speed pendant to be used. Activating this switch will prevent a 3-Speed *telePendant* from working properly on the receiver. This does not apply to 2-Speed applications.

Programming:

Turn the Rx Status Word switch S1 position 4 OFF (0) for the receiver to work with a *telePendant*.

Turn the Rx Status Word switch S1 position 4 ON (1) for the receiver to work with a JLTX, SLTX or older style 3-Speed 10K pendant transmitter. The crane configuration switches must all be programmed to off.

7-11.4. Rx Status Word S1-5 (16 or 24 Outputs). Normally ON (1) for 24 Output.

Definition: This configures the relay outputs on the receiver for 16 or 24 outputs.

Programming:

For 16 output applications, in the “Receiver Programmer” screen under “System” select “16 output” this turns Rx Status Word S1 position 5 OFF (0) automatically.

For 24 output applications, in the “Receiver Programmer” screen under “System” select “24 output” this turns Rx Status Word S1 position 5 ON (1) automatically.

7-11.5. Rx Status Word S1-6. (Active ESTOP enable). Normally OFF (0) for no Active ESTOP.

Definition: This feature causes the Receiver to shutdown if the transmitter is out of range. For this to work the companion transmitter must have this feature also. Please check the appropriate transmitter manual to see if your transmitter has this capability. All *inteleSmart* receivers have this feature; both the receiver and the transmitter must have this box checked. **DO NOT** use this feature with non equipped transmitters. It is not recommended to have multiple systems in the same area (600 feet) on the same frequency/channel if Active ESTOP is used, due to the additional frequency/channel loading.

Programming:

Turn Rx Status Word S1 position 6 OFF (0) for normal operation.

Turn Rx Status Word S1 position 6 ON (1) for the Active ESTOP feature. Matching transmitter must be programmed as such also.

7-11.6. Rx Status Word S1-7. (Time Out Timer Disable). Normally OFF.

Definition: The receiver has a 15 minute time out timer. If a receiver once turned ON by a transmitter does not receive a signal from any transmitter for a period of 15 minutes the receiver shuts down and opens the main line. This function disables this feature.

Programming:

Turn the Rx Status Word switch S1 position 7 OFF (0) for the receiver to have a 15 minute time out.

Turn the Rx Status Word switch S1 position 7 ON (1) for the receiver to have no time out timer.

7-11.7. Rx Status Word S2-1, -2 and -3. (Auxiliary Function Relay Latching). Normally All OFF, no latching.

Definition: Enables the appropriate auxiliary function relay to operate in a latched mode, ON or OFF, rather than as a momentary contact. Which function is latchable and which relay is latched depends on the particular receiver configuration used. See Section 6 – Wiring to determine location of Aux’s. **This function is not to be used for critical latching functions such as magnets.**

Programming:

Turn Rx Status Word S2 position 1 ON (1) for Aux 1 to latch.

Turn Rx Status Word S2 position 2 ON (1) for Aux 2 to latch.

Turn Rx Status Word S2 position 3 ON (1) for Aux 3 to latch.

Section 7 - programming (Continued)

7-11.8. Rx Status Word S2-7. (ESTOP Stop Alarm). Normally OFF (0).

Definition: Gives about 5 seconds of alarm when the Emergency Stop (ESTOP) is activated on the transmitter. This also allows the alarm button to function in the ESTOP mode.

Programming:

Turn the Rx Status Word switch S2 position 7 OFF (0) for the receiver ESTOP alarm disabled.

Turn the Rx Status Word switch S2 position 7 ON (1) for the receiver to have ESTOP alarm enabled.

Additional wiring required: This only works for configurations that have an alarm relay and an external alarm connected. See Section 6 – Wiring for the wiring location of the alarm relay. Jumper JU1 on the Receiver Board must be set for Alarm Relay to be activated during an ESTOP shutdown. See Figure 8-1. Receiver Board Layout for the position of JU1.

7-11.9. Rx Status Word S2-8. (Auto Alarm). Normally OFF (0).

Definition: Auto Alarm closes the alarm relay for about 5 seconds when the receiver is first turned on.

Programming:

Turn the Rx Status Word switch S2 position 8 OFF (0) for the receiver Auto Alarm to be OFF.

Turn the Rx Status Word switch S2 position 8 ON (1) for the receiver to have Auto Alarm.

Additional wiring required: This only works for configurations that have an alarm relay and an external alarm connected. See Section 6 – Wiring for the wiring location of the alarm relay.

7-11.10. Tx Status Word S3-1, -2 and -3. (Transmitter Motion Switch Rearrangement). Normally All OFF.

Definition: Through this feature the conventional arrangement of transmitter motion switch pairs, Hoist at the top, Trolley in the middle and Bridge at the bottom, can be changed without rewiring the receiver.

Programming:

Turn TX Status switch S3 positions 1 through 3 ON or OFF to obtain the desired configuration. See the Table 7-3 for the arrangement of programming switches verses motion switch pairs on the transmitter.

Section 7 - programming (Continued)

S3-1	S3-2	S3-3	Hoist	Trolley	Bridge
0	0	0	Pair 1	Pair 2	Pair 3
1	0	0	Pair 1	Pair 3	Pair 2
0	1	0	Pair 2	Pair 3	Pair 1
1	1	0	Pair 2	Pair 1	Pair 3
0	0	1	Pair 3	Pair 1	Pair 2
1	0	1	Pair 3	Pair 2	Pair 1

Table 7-3. Tx Switch S3-1, -2 and -3 Programming, see diagram below for switch pair location.

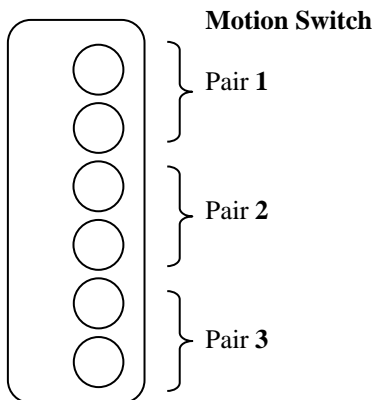

Figure 7-11. Transmitter Switch Pair Location.

7-11.11. Tx Status Word S3-5 through -8. (Pre-Configured Select for Custom Cranes Motors). Normally All OFF.

Definition: Certain types of cranes require custom relay programming; the most common variations of relay programming are preprogrammed into the *inteleSmart* receiver and are selectable through Tx Status Switch S3 positions 5 through 8. The available configurations are shown in Section 6 – Wiring.

Programming:

If a custom crane relay configuration is needed, locate the appropriate Table in the wiring diagrams in Section 6 – Wiring. Program all receiver switches and transmitter switches per the instructions under *RECEIVER And TRANSMITTER SWITCH SETTINGS* for that table.

Section 7 - programming (Continued)

7-11.12. Tx Status Word S4-1. (4/5 Motor Aux). Normally OFF.

Definition: The settings of this bit determine whether the receiver utilizes Select Bits or independent relay outputs for the Main/Aux Hoist, Main/Aux Trolley, and Main/Aux Bridge. Turning this bit to ON (1) activates Select Bits. Turning this bit to OFF (0) utilizes independent relay outputs and has no provision for an Aux Bridge.

Programming:

If independent relay outputs are desired, then refer to the wiring diagram in Section 6, pages 25 and 26. If select relay logic is needed, then refer to the wiring diagram in Section 6, pages 29 and 30. Program all receiver switches and transmitter switches per the instructions under *RECEIVER And TRANSMITTER SWITCH SETTINGS* per the application table.

Tx Status Word S4-2. (4 Motor). Normally OFF.

Definition: The settings of this bit disable the Auxiliary Trolley when independent relay outputs are selected. This feature cannot be used with select relay logic; therefore, S4-1 must remain OFF to utilize this function. Turning this bit ON (1) disables the Aux Trolley relay outputs.

Programming:

This setting uses the wiring diagram in Section 6, pages 25 and 26. When S4-2 is ON (1), then the “Aux Motor 2” outputs are not used. Program all other receiver switches and transmitter switches per the instructions under *RECEIVER And TRANSMITTER SWITCH SETTINGS*.

7-11.13. Tx Status Word S4-3. (Tandem Disable For Hoist, Trolley or Bridge). Normally OFF.

Definition: Normally for 4 or more motor operation, “Both A and B” operation is enabled (both MAIN and AUX motor or Select 1 and Select 2 can be ON at the same time). Turning ON (1) this feature disables the “Both” function. (“A” and “B” or Select 1 and Select 2 will not come on at the same time).

Programming:

Turn the TX Status Word S4 position 3 ON (1) to prevent both “A” and “B” or Select 1 and Select 2 from coming on at the same time. Tandem disable can also be set in the transmitter using the Palm. If the transmitter is set for tandem disable, then setting this receiver bit is optional, but not required. If the transmitter is NOT set for tandem disable, then this bit will cause the Aux Hoist/Aux Trolley to remain set in the receiver when the transmitter is in the “both” mode.

7-11.14. Tx Status Word S4-4. (Invert Crane Select Outputs). Normally OFF.

Definition: This feature is only for custom crane relay configurations using select relays. Turning this switch ON (1) reverses the select function operation so that the opposite relay closes for the selected function.

Programming:

Turn the Tx Status Word switch S4 position 4 ON (1) for to invert the operation of the Select 1 and Select 2 relays. With this switch ON (1) the “A” LED on the transmitter activates Select relay 1 and the “B” LED activates Select relay 2.

7-11.15. Tx Status Word S4-7. (By Pass Status Settings). Normally OFF.

Definition: This is used for 5 Speed configurations or to accommodate custom crane relay configurations when you wish to keep the custom crane relay configuration programming in the transmitter for transmitter compatibility with older systems. (Disabling and by passing receiver Tx Status switches S3-5 through -8).

Programming:

Turn Tx Status Word switch S4 position 7 ON (1) for 5-Speed applications or for older transmitters to generate crane configurations on this receiver as it does on the older 10K system. Refer to the older receiver manual custom crane configuration and look up the same crane configuration in this manual Section 6 – Wiring to determine the appropriate relay output in this receiver.

Section 7 - programming (Continued)

7-11.16. Tx Status Word S4-8. (User Configured). Normally OFF.

Definition: This is advanced programming that allows, through the PDA, custom output mapping of the relay closing per transmitter button activation. This is to be used only when the predefined custom crane configurations do not meet the requirements. If not familiar with this type of programming it might recommended that you contact your Telemotive representative.

Programming: Tx Status Word S4-8 Should be OFF (0) except for custom crane relay mapping. Custom relay mapping uses the boxes marked “Aux #” and “Motor #” at the bottom of the “Receiver Programmer”. These boxes become active when S4-8 is selected. **See Section 7-12. Using Custom Mapping for detailed instructions on custom mapping.**

7-12. Using Custom Mapping (For Advanced Programming Only):

Custom Mapping Step 1:

With the custom mapping determined that needed for your system, program in all other receiver parameters, frequency access code receiver type etc. Go to the “set Status” screen (if in the “Receiver Programmer” tap the button marked “Status”). Turn Receiver Status Word S4-8 ON (1). And tap the box marked “Save” taking you back to the “Receiver Programmer” screen. Load this program into the receiver following the procedure in Section 7-10. Loading The Program.

Custom Mapping Step 2:

At the bottom of the “Receiver Programmer” screen tap one of the screen buttons marked “Aux” to open the “Auxiliary Table” or “Motor #” to open the “Motor # Table”.

Custom Mapping Step 3:

With the appropriate Table open, rows of boxes marked Motor #, Dir 1 and Dir 2, 1st, 2nd and 3rd or Aux Motor #'s are seen. These labels identify the appropriate transmitter function buttons being mapped and their speed steps. The boxes number from 1 on the left to 12 on the right. These represent output relays-see diagram (Figure 7-12. Custom Mapping Diagram) below for the physical position of these relays. Output relays 13 through 24 can be found by tapping the box “Page 1” at the bottom of the screen. A zero (0) shown in a box, default condition, means the respective relay is open when this function button is energized. Tapping a single box will cause the box to darken and show a “1” this means this relay will close when this function is energized on the transmitter. Tap the appropriate relay(s) you wish to close for all shown functions and speeds. When completed doing all shown functions on the screen (All shown functions must be programmed or no relays will close for the missed function button) tap the button marked “Save”.

Custom Mapping Step 4:

Repeat Step 3 until all functions both “Aux’ and “Motor #” have been programmed and saved. (All function buttons must be programmed or no relays will close for the missed function button).

Custom Mapping Step 5:

Save the program on the PDA and load into the receiver following the procedure for loading in Section. 7-10, however only use the menu item “Send App Table” instead of “Send Settings”. The Comm Menu will also let you read the current mapping using “Receive App Table”. Sending the mapping functions does NOT set any frequency or access code parameters. They must be sent separately as described in Section 7-10 Loading The Program.

Custom Mapping Step 6:

With power applied to the receiver turn switch SW2 OFF (MR relay control) and SW1 ON (main power switch). Stand clear of the crane and apply AC power to receiver unit. WAIT TEN SECONDS. Check to see if at least the three green LEDs DS1, DS2 and DS3 are ON, as well the red RF Receiver ON LED (other LEDs may be ON also). If none are lit check AC power and power switch SW1. See Figure 8-1. Receiver Layout for switch and LED locations.

Custom Mapping Step 7:

Program the *tele*Pendant transmitter with matching frequency and Access Codes. Select under “Motor” the number “5”. For JLTX and SLTX transmitters, program in the receiver Rx S1 position 4 ON (1) and in the transmitter turn switches SW3 “C” positions 1 through 7 and SW4 “D” positions 1 through 8 OFF. If Tandem Disable is selected in the receiver programming Tandem Disable should also be set in the transmitter.

Section 7 - programming (Continued)

Custom Mapping Step 8:

Turn transmitter ON. Check to see if the red LEDs DS30 and DS32 are now ON. At this point the MR relay is disabled; the functions of the transmitter can be checked by noting the turning ON of the appropriate red LEDs next to the control relays (K1-K24). After checking out the functions, turn switch SW2 ON to enable the MR relay (red LED DS31 should now turn ON), check function and direction by jogging each motion. Installation should now be complete.

NOTE

When using Custom Mapping the following options are still active and programmable:

- Receiver time-out timer
- Latching Aux. relays (Up to 3, See Figure 7-12. for location)
- Auto Alarm (See Figure 7-12. for location)
- Alarm after ESTOP (See Figure 7-12. for location)
- Group Code
- Active ESTOP
- Tandem disable

For any of the above see the previous write-up in the section and follow the stated instructions.

The following should not be used, but be taken into account by the custom mapping:

- 4 /5 Aux
- 4 motor
- Invert crane select
- Custom crane configurations
- Transmitter button position

Section 7 - Programming (Continued)

Figure 7-12. Custom Mapping Diagram.

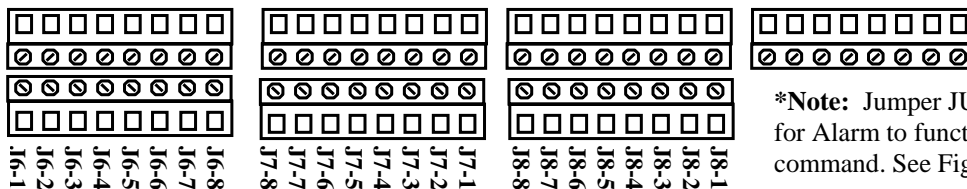
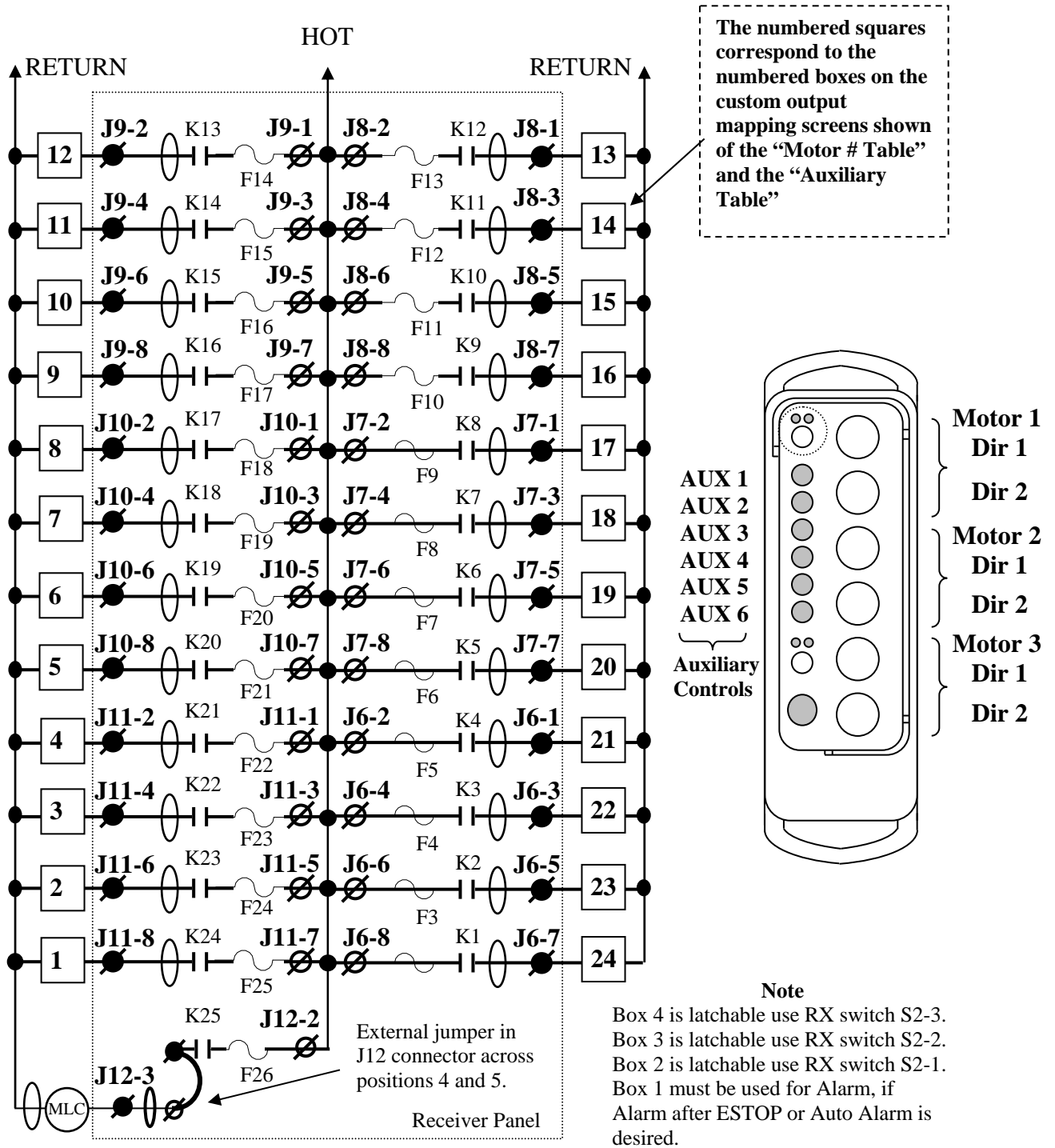

***Note:** Jumper JU1, Receiver Board for Alarm to function after an E-Stop command. See Figure 8-1.

Section 7 - Programming (Continued)

7-13. Access Codes.

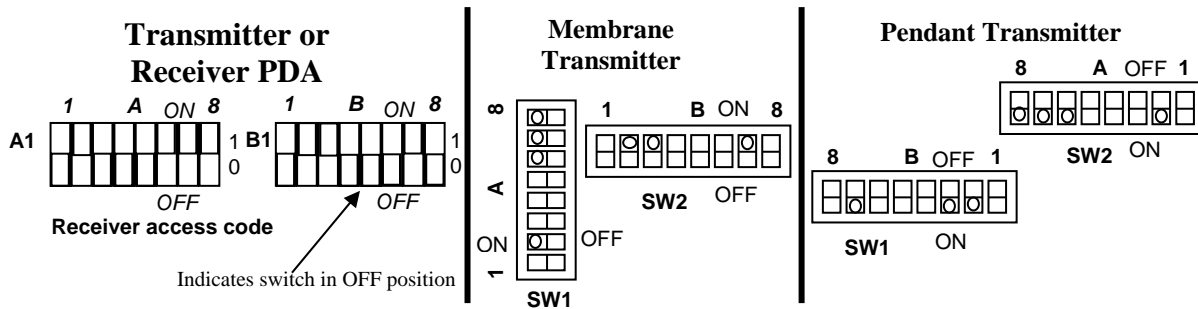

MODEL # -10KXXXXXXXXXX
 S/N=XXXXXXXXXXXXXXXXXXXX
 ACCESS CODE SETTING
1 A 8 1 B 8
 01000111 01100010
 FREQ: = AK01 J# = XXXXX

**Sample Membrane or Pendant Transmitter
 Access Code Label**
Sample access code only do not use

Figure 7-13. Access Code Setting.
 (A dot on a switch position or a "1" in the label is an indication that the respective switch position should be ON).

7-13.1. Access Code Programming.

The access code is set at the factory and should not be changed unless absolutely necessary. The programming in the receiver(s) must match the transmitter. If you are reprogramming a spare or new transmitter make sure the other transmitter is securely taken out of service.

For detailed instructions on setting Access Codes see Section 7-7. Programming Access Code.

After changing the access code, test the receiver with a matching transmitter. If the red LED DS6 comes ON in the receiver the code does not match, recheck the access code settings.

Section 7 – Programming (Continued)



WARNING

THE ACCESS CODES IN THE RECEIVER ARE UNIQUE AND FACTORY PRESET. DO NOT CHANGE THESE ACCESS CODES UNLESS YOU ARE REPLACING AN EXISTING RECEIVER AND ITS ACCESS CODE. CHANGING THIS CODE COULD MAKE IT COMMON WITH ANOTHER RECEIVER ACCESS CODE, WHICH COULD MOVE ANOTHER CRANE. NO TWO SYSTEMS IN ANY LOCATION SHOULD EVER HAVE THE SAME ACCESS CODES INDEPENDENT OF FREQUENCY.

TWO OPERATIONAL TRANSMITTERS WITH THE SAME ACCESS CODES OPERATING AT THE SAME TIME IS A DEFINITE SAFETY HAZARD.

AFTER CHANGING THE ACCESS CODES, TEST THE TRANSMITTER BY TURNING IT ON AND OFF NEAR THE RECEIVER. IF THE RECEIVER DOES NOT RESPOND, DO NOT ACTIVATE A FUNCTION BUTTON! THE TRANSMITTER MAY HAVE THE WRONG ACCESS CODE, WHICH COULD MOVE ANOTHER CRANE. RE-CHECK THE ACCESS CODE AND RETEST.

FAILURE TO FOLLOW THESE WARNINGS COULD RESULT IN SERIOUS INJURY OR DEATH AND DAMAGE TO EQUIPMENT.

7-14. Receiver Frequency Programming.

The receiver is equipped with a frequency synthesizer that allows frequencies to be easily changed without retuning. Normally the frequency does not have to be changed; the unit comes programmed to a specific frequency listed on the Frequency and Access Code Label on the receiver door. Programming is done with the PDA. See Section 7-4. Programming Frequency.

7-14.1. RF Receiver Board Frequency Synthesizer.

Located in the receiver is the RF Receiver Board. The circuitry on this board contains a digital oscillator and synthesizer that are controlled by a microprocessor. This eliminates the need for specific crystals to change frequencies. The onboard microprocessor automatically retunes the RF receiver when the channel is changed; no retuning or any other adjustment is required.

Section 7 – Programming (Continued)

7-14.2. Reprogramming The Synthesizer.

The RF Receiver is programmed in the unit by the *inteleSmart* logic. Frequencies are set by the PDA. See Programming Section. If the RF Receiver is changed and it needs to be programmed by the receiver, this can be done by reprogramming with the PDA or turning on the main power (S1) to the *inteleSmart* receiver while holding down the push button SW3. SW3 should be held down until DS13 goes out (approximately 10 seconds).

The frequency of the unit can be checked either with or without the PDA by checking the channel count to verify that the RF Receiver is programmed to the desired channel.

Channel and Frequency Designations by Count.

Indicator Count	Channel Designator	Actual Frequency
1.	AK01	439.8 MHz
2.	AK02	439.6 MHz
3.	AK03	439.4 MHz
4.	AK04	439.2 MHz
5.	AK05	439.0 MHz
6.	AK06	438.8 MHz
7.	AK07	438.6 MHz
8.	AK08	438.4 MHz
9.	AK09	438.2 MHz
10.	AK10	438.0 MHz
11.	AK11	437.8 MHz
12.	AK12	437.6 MHz
13.	AK13	437.4 MHz
14.	AK14	437.2 MHz
15.	AK15	437.0 MHz
16.	AK16	436.8 MHz
17.	AK17	436.6 MHz
18.	AK18	436.4 MHz
19.	AK19	436.2 MHz
20.	AK20	436.0 MHz
21.	AKA00	433.125 MHz
22.	AKA01	433.325 MHz
23.	AKA02	433.525 MHz
24.	AKA03	433.725 MHz
25.	AKA04	433.925 MHz
26.	AKA05	434.125 MHz
27.	AKA06	434.325 MHz
28.	AKA07	434.525 MHz
29.	AKA08	434.725 MHz
38.	AK38	432.4 MHz
50.	AK50	430.0 MHz

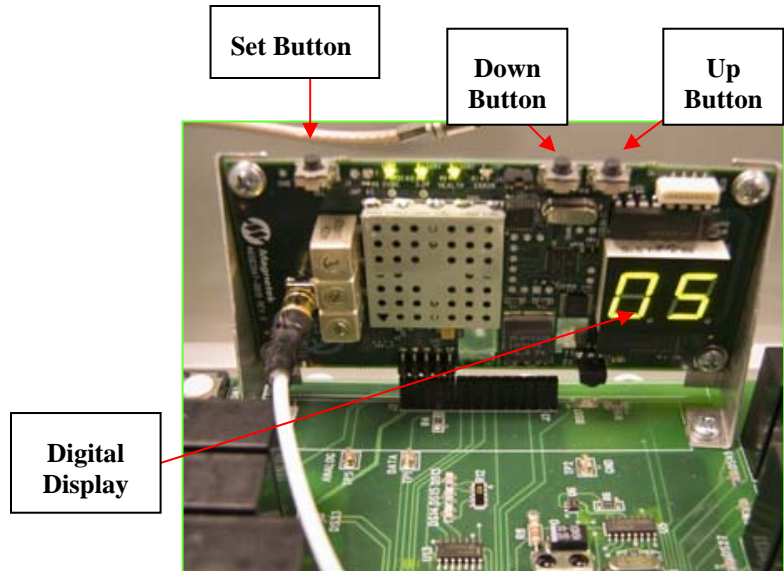

Section 7 – Programming (Continued)

7-14.3. Manually Reprogramming The Synthesizer.

NOTE

THE RF RECEIVER CAN BE REPROGRAMMED IN THE UNIT WITHOUT USING THE PDA. THIS SHOULD ONLY BE DONE ON AN EXCEPTION BASIS FOR INTELESMART RECEIVERS. PROGRAMMING THIS WAY DOES CHANGE THE RF FREQUENCY, BUT DOES NOT UPDATE THE PDA SETTING.

To change the frequency, find the indicator count on the “Channel and Frequency Designation by Count” for your desired frequency. To increase the Indicator count, press the up button until the proper indicator count is displayed. Then, press the set button.

To decrease the Indicator count, press the down button until the proper indicator count is displayed. Then, press the set button.

To reset the frequency to the PDA programmed value see Section 7-6. Programming Frequency.

7-14.4. Signal Strength Indicator Mode

The new RF Module is capable of measuring the signal strength for the selected channel. To set the RF Module to the signal strength indicator Mode, press and hold the set button until the digital display goes blank. Then, let off the set button. Now, the display will indicate the strength of a signal on that channel.

This feature can be helpful in identifying the best frequency for your Telemotive System. If your transmitter is off and the signal indicator shows a number, consider moving the system to another frequency.

Industry Canada Statement per Section 4.0 of RSP-100

The term "IC:" before the certification / registration number only signifies that the Industry Canada technical specifications were met.

Section 7.1.5 of RSS-GEN

Operation is subject to the following two conditions:

- 1) this device may not cause harmful interference, and
- 2) this device must accept any interference received, including interference that may cause undesired operation.

Section 8 – RCP Programming

8-1. Receiver Programming Overview.

Historically in Telemotive's 10K systems the user had to program the transmitter for frequency, access code plus all number of additional parameters for a special crane application. Special relay configurations were programmed in the transmitter for different types of crane motor, i.e., ACCO, Demag etc. Now with *inteleSmart* receiver these features only have to be programmed in the receiver once so that a basic configured transmitter (frequency, access code and number of motors) can properly operate any crane configuration. Also with *inteleSmart* the receiver's configurations are easily configured using Magnetek's Radio Control Programmer (RCP).

Magnetek RCP software is user friendly and is intended to provide plain language descriptions of all transmitter functions and options. Help is provided for each function at the bottom of the RCP screen. The RCP software allows you to select frequency, access code, time-out-timer settings, switch arrangement and crane configuration as in other Telemotive transmitter products. Follow the steps below:

Install the RCP software.



After installation of the RCP Software, double-click the RCP icon found on the desktop to launch the program. This will prompt you to enter an activation key. If an activation key is not entered at this time, the software can only be used 10 times before locking the user out. Contact customer service or your sales representative for an activation key.

A screenshot of a Windows-style dialog box titled "Activate Radio Control Programmer". The dialog box contains a message: "Please complete the information below. All fields marked with an asterisk (*) are required fields." Below the message are several input fields: "*First Name", "*Last Name", "*Organization", "*Email", "Phone (000) 000-0000", and "*Product Key" (with five separate boxes for digits and dashes). At the bottom of the dialog box are three buttons: "Cancel", "Activate Later", and "Activate Now".

Section 8 – RCP Programming (Continued)

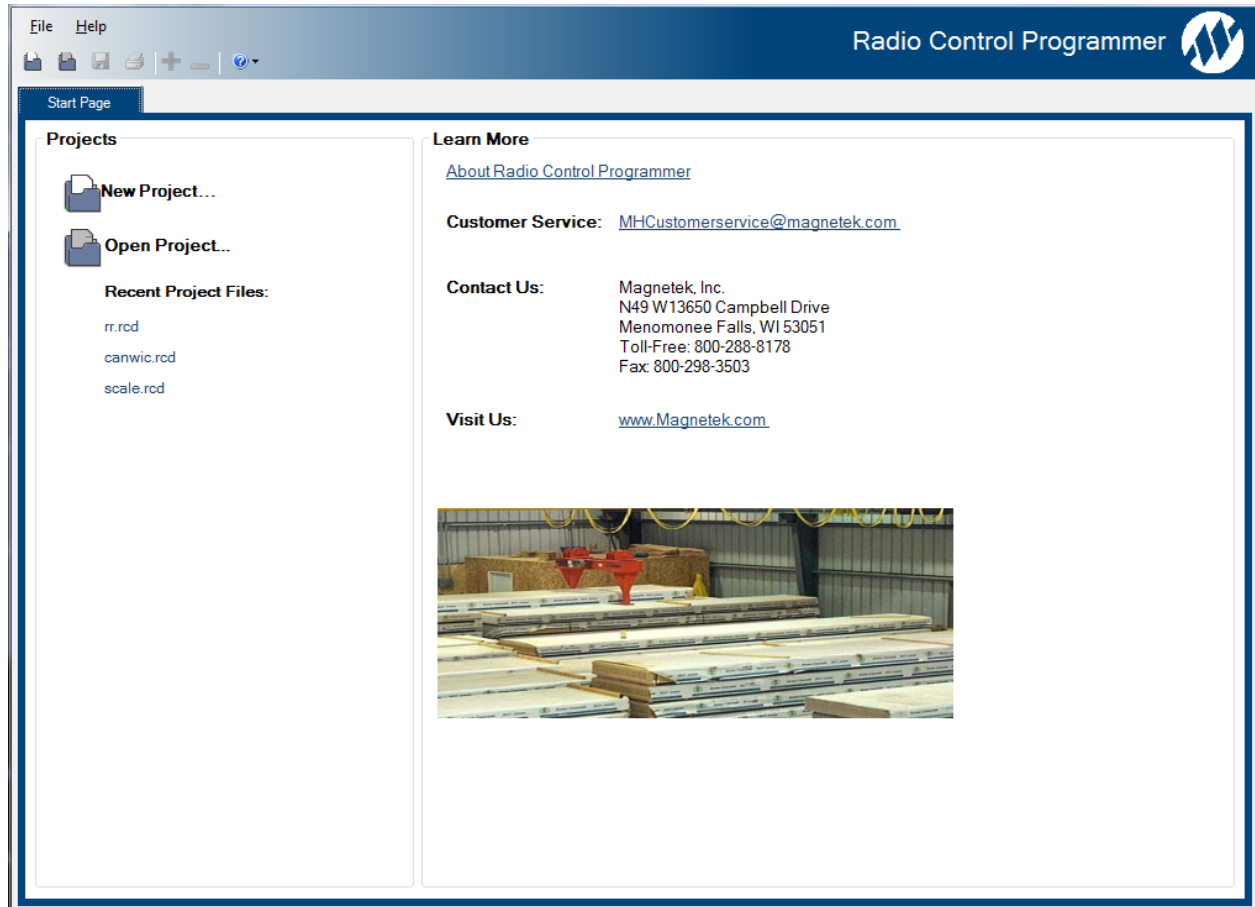

Click on New Project or Open Project

Select new project if you are creating a new program file. Select open project if you want to retrieve an existing program file. A list of recent projects will appear under Open Project. Clicking on one of these will open that project. It is recommended that you create a folder in which to save all programming files.

Select Project Type

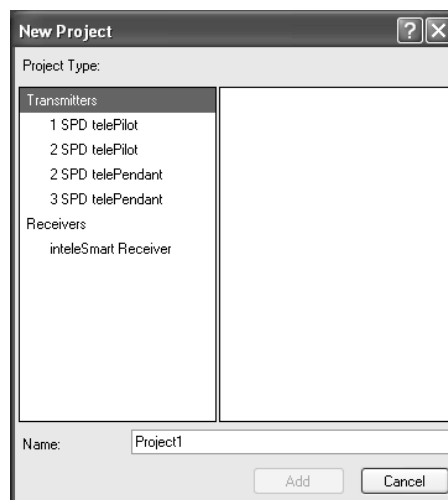

Section 8 – RCP Programming (Continued)

A menu will open listing the available project types. Select the one that matches the product you wish to program. (Selecting a project type will display a picture of the product for verification.)

Receiver Programming.

The *inteleSmart* receiver comes preprogrammed. Additional programming is not normally needed. After selecting *inteleSmart* receiver, the first screen is the initial setup screen. See Figure 8-1: Receiver Programming Screen.

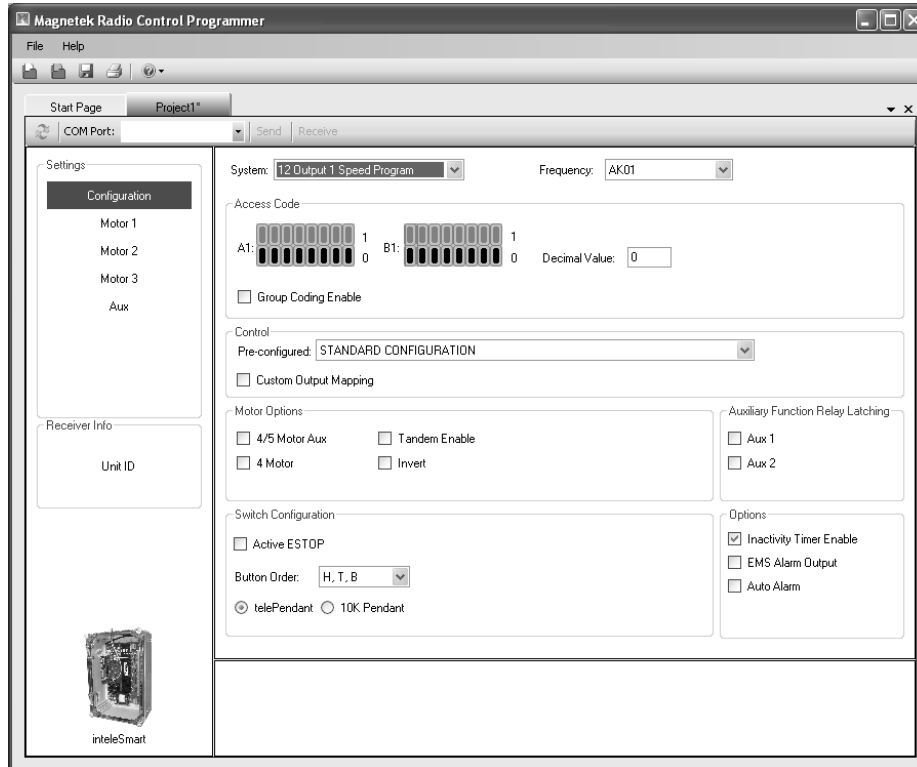
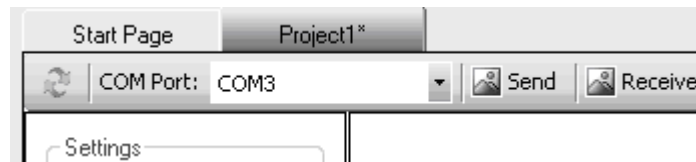

Figure 8-1: Receiver Programming Screen

8-2. Downloading Parameters from an *inteleSmart* receiver.

To read current programming, aim the IR adaptor at the upper left hand corner of the receiver, turn the receiver ON using switch S1 and within 5 seconds click the receive button. An acknowledgement message will be displayed confirming status down loading.



NOTE

THE RECEIVER IS IN THE PROGRAMMING MODE FOR ABOUT 10 SECONDS AFTER CYCLING THE POWER SWITCH. DURING THIS TIME LED DS13, GREEN, WILL BE ON SOLID AND LED DS15, RED, WILL FLASH. IF THE UNIT IS NOT PROGRAMMED OR DATA READ DURING THIS TIME THE POWER MUST BE RECYCLED TO RE-ENTER THE PROGRAMMING MODE.

Section 8 – RCP Programming (Continued)

This information can now be saved using the file menu. This menu allows you to create new files, open existing files, delete files, save files and rename existing files.

8-3. Saving Settings.

If the settings need to be changed, check the appropriate boxes for the changes, save the file and send it to the receiver using the same procedure as was used to download the settings, only click on send button instead of receive. Remember to cycle the ON/OFF switch S1 on the Receiver to put the unit in the programming mode.

8-4. Programming Frequency.

Select a Frequency (Must be inputted and match the respective transmitter for system to work):

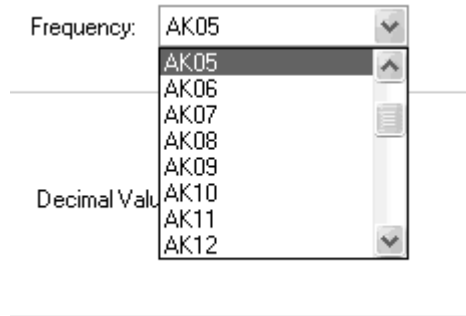

There should be a label either on the receiver or the transmitter being replaced listing frequency, it should be a channel number between AK01 and AK20, AKA00 to AKA08, AK38 or AK50. Find this number and use the pull down arrow to click that frequency.

For more details on receiver frequencies, reading or programming them without using RCP software see Section 7-13.

Programming Access Code.

Enter the Access Code (Must be inputted and match the respective transmitter for system to work):

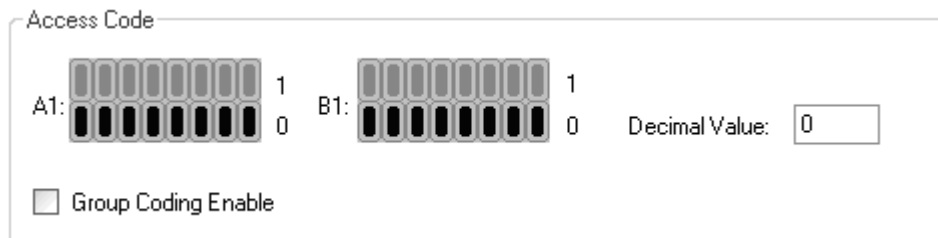

Enter the Access Code (Must be set for system to work):

Screen switch operation.

The screen switches are labeled from left to right “A”, and “B”. They are numbered from left to right 1 to 8. The black rectangle to the bottom is “OFF” or “0” the green rectangle to the top is “ON” or a “1”. Clicking the grey rectangle will cause the switch to toggle. There is also a box which shows the decimal value of the binary number entered. Some receiver types will show the access code as a decimal number. That number can be entered here.

See Section 7-13. Access Codes for important details on access code programming. There should be a label either on the receiver or the old transmitter showing the access code, it should be numbered A1 through A8 and B1 though B8. Find this number and tap the respective switches on the screen. If you cannot find a label with access code information, copy

Section 8 – RCP Programming (Continued)

directly from the access code dip switches in your transmitter or receiver, being careful to match the designation and switch position as they do vary from model to model.

8-5. Programming a Receiver Type. (This must be correctly inputted for the System to work properly).

The receiver is determined by the number of outputs 12 output 1 speed, 12 output 2 speed, 16 output and 24 output. Select the Type that matches your receiver.

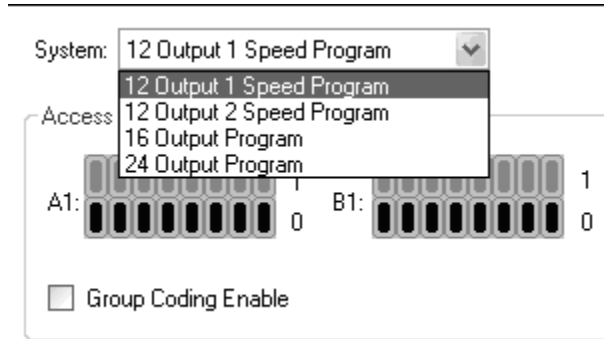

Programming Receiver Status Word.

The parameters formerly set using the status words have been changed to plain language selections on the main receiver programming screen. Descriptions of these parameters are shown below.

Group Code:

GROUP CODE DIFFERS FROM MULTIBOX IN THAT THE ACCESS CODES DO NOT HAVE TO BE SEQUENTIAL.

Definition: Group Code capability allows up to 8 transmitters to access a single receiver on a first come first served basis. Only one transmitter may control the receiver at a given time. Once a transmitter has gained control, another transmitter may not access the receiver until the controlling transmitter relinquishes control by transmitting an OFF command to the receiver or the receiver times out due to inactivity.



WARNING

IF YOU NEED TO ADD GROUP CODE OR ADD ADDITIONAL TRANSMITTERS PLEASE CONTACT TELEMOTIVE FOR ASSISTANCE WITH THIS FEATURE. FAILURE TO FOLLOW THIS WARNING COULD RESULT IN SERIOUS INJURY OR DEATH AND DAMAGE TO EQUIPMENT.

Checking the group code box will bring up a pull down to select the number of access codes the receiver should accept, from 1 to 8. Note that mini help will be displayed at the bottom of the screen for each option as you mouse over it.

Section 8 – RCP Programming (Continued)

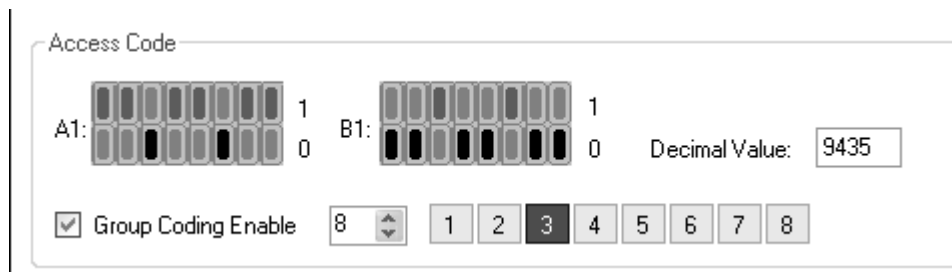
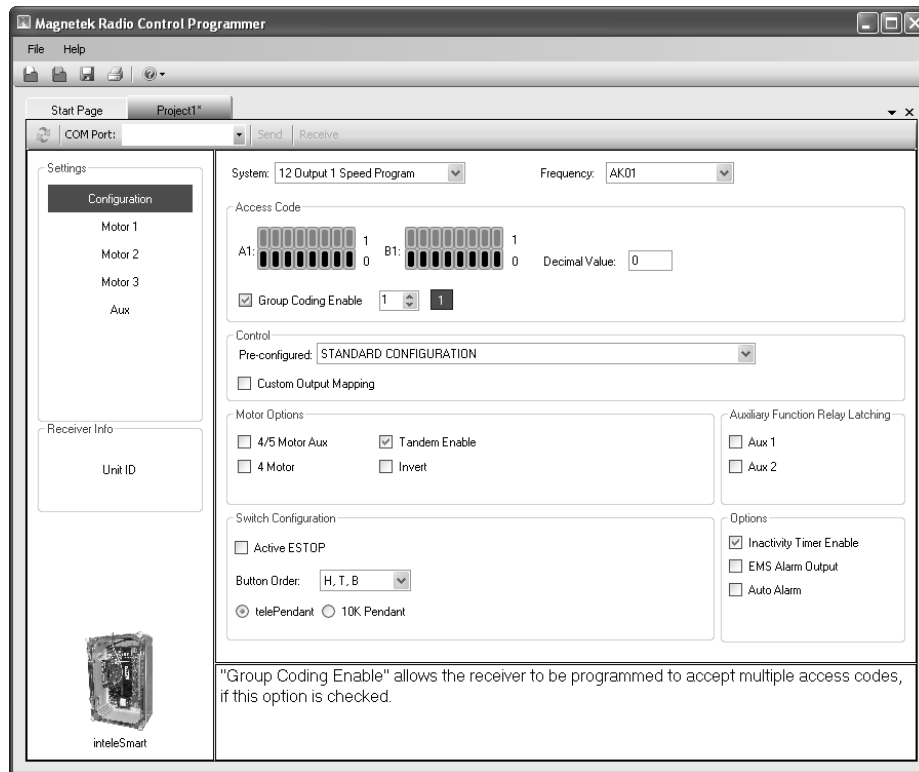

Enter each access code that the receiver should accept by clicking each number button and setting that access code as above.

telePendant/10KPendant selection:

Definition: This is **only** used for **3-Speed** receiver applications to allow a JLTX, SLTX or older style 10K 3-Speed pendant to be used. Activating this switch will prevent a 3-Speed *telePendant* from working properly on the receiver. This does not apply to 2-Speed applications.

Check the button for the transmitter type desired.

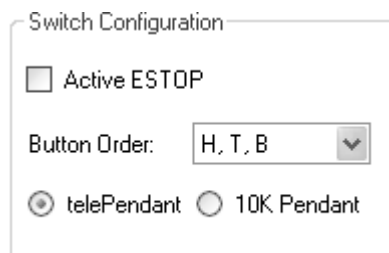

Section 8 – RCP Programming (Continued)

Active E-Stop:

Definition: This feature causes the Receiver to shutdown if the transmitter is out of range. For this to work the companion transmitter must have this feature also. Please check the appropriate transmitter manual to see if your transmitter has this capability. All *inteleSmart* receivers have this feature; both the receiver and the transmitter must have this box checked. DO NOT use this feature with non equipped transmitters. It is not recommended to have multiple systems in the same area (600 feet) on the same frequency/channel if Active ESTOP is used, due to the additional frequency/channel loading. Check the active E-Stop box if this feature is desired.

Inactivity Timer Enable: (normally checked)

Definition: The receiver has a 15 minute time out timer. If a receiver once turned ON by a transmitter does not receive a signal from any transmitter for a period of 15 minutes the receiver shuts down and opens the main line. Unchecking this box disables this feature.

Auxiliary Relay latching: (normally not checked)

Definition: Enables the appropriate auxiliary function relay to operate in a latched mode, ON or OFF, rather than as a momentary contact. Which function is latchable and which relay is latched depends on the particular receiver configuration used. See Section 6 – Wiring to determine location of Aux's. Check the box for each relay that needs to be latching. **This function is not to be used for critical latching functions such as magnets.**

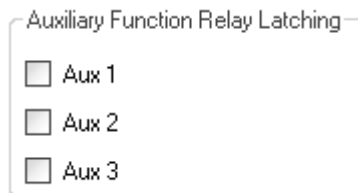

EMS Alarm Output:

Definition: Gives about 5 seconds of alarm when the Emergency Stop (ESTOP) is activated on the transmitter. This also allows the alarm button to function in the ESTOP mode. Check if desired.

Auto Alarm:

Definition: Auto Alarm closes the alarm relay for about 5 seconds when the receiver is first turned on.

Button Order: (12 and 16 output only)

Definition: Through this feature the conventional arrangement of transmitter motion switch pairs, Hoist (H) at the top, Trolley (T) in the middle and Bridge (B) at the bottom, can be changed without rewiring the receiver. To change simply select the desired order from the pull down menu.



Changes the functional position of the buttons controlling Hoist, Trolley and Bridge. This does not affect Receiver wiring. The Motor controlled by a set button pair will change as "S3-1", "S3-2" and "S3-3" are changed.

Section 8 – RCP Programming (Continued)

Preconfigured:

Definition: Certain types of cranes require custom relay programming; the most common variations of relay programming are preprogrammed into the *inteleSmart* receiver and are selectable using a plain language pull down menu. The available configurations are shown in Section 6 – Wiring. The selections match the title of the wiring diagrams.

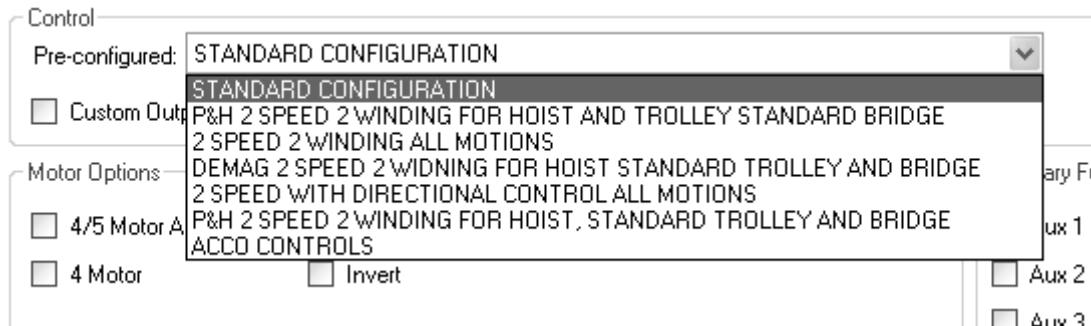

4/5 Motor Aux

Definition: The settings of this bit determine whether the receiver utilizes Select Bits or independent relay outputs for the Main/Aux Hoist, Main/Aux Trolley, and Main/Aux Bridge. Checking this box activates Select Bits. Unchecking this box utilizes independent relay outputs and has no provision for an Aux Bridge.

4 Motor

Definition: The settings of this bit disable the Auxiliary Trolley when independent relay outputs are selected. This feature cannot be used with select relay logic; therefore, box must remain unchecked to utilize this function. Checking this box disables the Aux Trolley relay outputs.

Tandem Enable:

Unchecking this box disables tandem operation.

Invert:

Definition: This feature is only for custom crane relay configurations using select relays. Turning this switch ON (1) reverses the select function operation so that the opposite relay closes for the selected function. This feature is most commonly used on European hoists.

Bypass: (24 output only)

Definition: This is used for 5 Speed configurations or to accommodate custom crane relay configurations when you wish to keep the custom crane relay configuration programming in the transmitter for transmitter compatibility with older systems. Used when operating the receiver with a 5 speed belly box transmitter. 10K Pendant option MUST be checked when using bypass.

Section 8 – RCP Programming (Continued)

Custom Output Mapping:

Definition: This is advanced programming that allows, through the RCP, custom output mapping of the relay closing per transmitter button activation. This is to be used only when the predefined custom crane configurations do not meet the requirements. If not familiar with this type of programming it is recommended that you contact your Magnetek representative.

When using Custom Mapping the following options are still active and programmable:

- Receiver time-out timer
- Latching Aux. relays (Up to 3, See Figure 7-12. for location)
- Auto Alarm (See Figure 7-12. for location)
- Alarm after ESTOP (See Figure 7-12. for location)
- Group Code
- Active ESTOP
- Tandem disable

For any of the above see the previous write-up in the section and follow the stated instructions.

The following should not be used, but be taken into account by the custom mapping:

- 4 /5 Aux
- 4 motor
- Invert crane select
- Custom crane configurations
- Transmitter button position

Loading the Program.

When done entering all the parameters on the RCP, save the project. Cycle the power to the *inteleSmart* receiver (switch SW1). Within the first 10 seconds of the receiver turning ON, the LEDs DS13, green, will turn ON and DS15, red, will flash. Point the IR adaptor at the receiver's IR port (see Figure 8-1. Receiver Layout for locations) and click "Send". All parameters will be downloaded. DS14 will turn ON indicating the program was successfully downloaded. If DS13 turns OFF before downloading, recycle the power switch SW1.

Section 9 – Servicing (Continued)

Table 8-1. Receiver Diagnostic LED Functions. (See Figure 8-1. Receiver Layout for LED locations).

LED	COLOR	FUNCTION
RF Receiver 5 V 3.3 V	Green	<p>Power is ON to the RF Receiver.</p> <p>Normally ON.</p> <p>Monitors power to the RF Receiver Board. If the main receiver is ON and the RF Receiver ON LED is OFF. Check to see if the RF Receiver Board is properly plugged in to the main board.</p>
DS1	Green	<p>Monitors regulated 5 VDC power.</p> <p>Normally ON when AC line is present.</p> <p>If 5 VDC power is present then the LED is ON. The LED is OFF if 5 VDC power is not present. Check the 5 VDC regulator and for shorts on the Board.</p>
DS2	Green	<p>Monitors the regulated 12 VDC power.</p> <p>Normally ON when AC line is present.</p> <p>If 12 VDC power is present then the LED is ON. The LED is OFF if 12 VDC power is not present. Check the 12 VDC regulator and for shorts on the Board.</p>
DS3	Green	<p>Monitors the unregulated DC power to the 12 volt regulator</p> <p>Normally ON when AC line is present.</p> <p>If AC Power is present and the AC to DC converter is working then the LED is ON. The LED is OFF if DC power is not present. Check power supply, fuses and if power is applied to the receiver.</p>
DS4	Yellow	<p>Monitors data synchronization. (Flashes when a properly formatted data signal is received from the transmitter).</p> <p>This LED will flash rapidly when data is transmitted. The LED can be used with DS6 to analyze incoming data. If DS6 is ON or flashing when DS4 also is flashing, another Transmitter Unit on the same frequency may be present. This is normal. As more Transmitter Units operated on the same frequency, LED will flash brighter and more often.</p>
DS5	Yellow	<p>Monitors continuity between receiver RF module and CPU module.</p> <p>Normally ON during transmit function from TX.</p> <p>OFF indicates an inactive transmitter.</p>
DS6 Check this first!	Red	<p>Monitors received data errors. Wrong Access Code.</p> <p>Normally OFF.</p> <p>If LED is ON continuously when data is transmitted and the system does not respond the Access Code of the Receiver and Transmitter Units may not match. A flashing LED during data transmission may indicate interference of the received data. If LED is ON when data is not transmitted, another Transmitter Unit may be present on the same frequency with a different Access Code. The presence of activity on this LED does not necessarily indicate a problem. It should be used with other indicators in analyzing system status.</p>

Section 9 – Servicing (Continued)

LED	COLOR	FUNCTION
DS7	Yellow	<p>Monitors system activity.</p> <p>Normally FLASHING.</p> <p>OFF indicates a malfunctioning CPU. Replace EPROM.</p>
DS8	Red	<p>Monitors the ON command from the Transmitter.</p> <p>LED will flash when an ON command is being received from the Transmitter.</p> <p>While pushing the ON button on the Transmitter this should light.</p>
DS9	Red	<p>Monitors the OFF command from the Transmitter.</p> <p>LED will flash when an OFF command is being received from the Transmitter Unit.</p> <p>While pushing the OFF button on the Transmitter this should light.</p>
DS10	Red	<p>Monitors ESTOP condition.</p> <p>Normally OFF.</p> <p>LED will flash when an ESTOP command is transmitted and illuminate continuously when the ESTOP condition is in effect. An ESTOP condition may be created when an ESTOP command is transmitted or when a microprocessor failure mode is detected.</p>
DS11	Green	<p>Monitors if the unit is programmed for the “telePendant” Mode.</p> <p>Normally ON when programmed for the “telePendant” Mode.</p> <p>Must be ON for the telePendant to work properly on the system. Should be OFF for JLTX, SLTX and older style 10K pendant operation. See Section 7-11.3 for details.</p>
DS12	Red	<p>Monitors the watchdog timer.</p> <p>Normally OFF.</p> <p>The LED will illuminate momentarily when power is applied to or removed from the system. If the LED is continuously flashing or ON, the computer is not working properly. If LED is ON constantly (no flashing), the +5 VDC is probably too low. This could be caused by shorts on the board or by a defective voltage regulator. If the LED flashes at a constant rate, the microcomputer chip or EPROM may be defective.</p>
DS13	Green	<p>Monitors if the unit is programming mode.</p> <p>Normally OFF. Is ON for the first 10 seconds the power to the receiver is turned on.</p> <p>Must be ON to use the PDA to download or upload a program. If OFF, recycle the power switch SW1.</p>
DS14	Green	<p>Monitors if the unit was successful in communicating with the PDA.</p> <p>ON if the unit was successful in communicating with the PDA.</p> <p>If during the current power up settings were successfully sent or received with the PDA this light turns ON and stays ON till the power is recycled.</p>

Section 9 – Servicing (Continued)

LED	COLOR	FUNCTION
DS15	Red	<p>Monitors if the unit is programming mode.</p> <p>Normally OFF. Flashes ON for the first 10 seconds the power to the receiver is turned ON.</p> <p>Must be flashing to use the PDA to download or upload a program. If OFF, recycle the power switch SW1. DS15 flashes 5 times before the receiver reverts to normal operation</p>
K1-K24	Red	<p>Monitors closure of the output relays (K1-K24).</p> <p>Normally ON for a function when that specific function is enabled.</p> <p>The LED will be ON when a specific relay has been enabled by the respective command received from the Transmitter Unit. The LED will extinguish, when the command is no longer detected.</p>
DS30	Red	<p>Monitors the input to the Security Relay (K26).</p> <p>Normally ON when the receiver is enabled.</p> <p>If the system is ON and the light is not lit there is a serious microprocessor error, try replacing the EPROM.</p>
DS31	Red	<p>Monitors closure of the Master Control Relay (MCR) relay.</p> <p>LED will be ON when the MCR relay has been enabled by an ON command received from the Transmitter Unit. LED will extinguish, when an OFF command has been transmitted, an ESTOP condition is present, or SW2 is set to OFF.</p> <p>The MCR controls the power to the Main Line Contactor. If it does not come ON in normal operation check that SW2 is ON and no ESTOP condition exists.</p>
DS32	Red	<p>Monitors closure of the Security Relay output (K26).</p> <p>The LED will be ON when the Security Relay has been enabled by an ON command received from the Transmitter Unit. LED will extinguish when an OFF command is transmitted, or an ESTOP condition is present.</p> <p>The Security Relay controls the 12 VDC power to the MCR relay (MR). If DS30 is ON and not DS32 check that switch SW2 is ON if SW2 is ON then try replacing the security relay K26.</p>

Section 10 – Spare Parts

RECEIVER

PART NUMBER

DESCRIPTION

E13158-D	RF SYNTHESIZED RECEIVER MODULE ASSEMBLY
H310-0	RF RECEIVER MODULE ASSEMBLY MOUNTING SCREWS (4)
MP18005-0	RF RECEIVER MODULE MOUNTING BRACKET TOP SIDE (LEFT)
MP18005-1	RF RECEIVER MODULE MOUNTING BRACKET TOP SIDE (RIGHT)
H906-0	RF RECEIVER MODULE MOUNTING BRACKET SCREW (2)
AN100-1	ANTENNA CONNECTOR PLUG IN:
TS1060-3	3 POSITION
TS1060-8	8 POSITION
CR260-0	MOV
K1304-0	RELAY (OUTPUT) (25)
WA12038-0	EXTERNAL ANTENNA CABLE (Does not include antenna).
A525-1	ANTENNA MOUNT ASSEMBLY.
WA104-20	CABLE ASSEMBLY, 20 FOOT (For remote antenna mounting requires WA12038-0 and A525-1).
E10134-0	MAIN MODULE
FW2926-1	FIRMWARE
178-01483-0010	STANDARD ENCLOSURE WITH ANTENNA HOLE
178-01483-0020	ENCLOSURE WITH ANTENNA AND PIGTAIL HOLES
178-01483-0030	ENCLOSURE WITH ANTENNA, PIGTAIL, AND TRANSFER SWITCH HOLES
178-01702-0100	RADIO CONTROL PROGRAMMER WITH IR ADAPTER COMMUNICATION