

# spacevector™

## SV100

## INSTALLATION, PROGRAMMING & SERVICE MANUAL

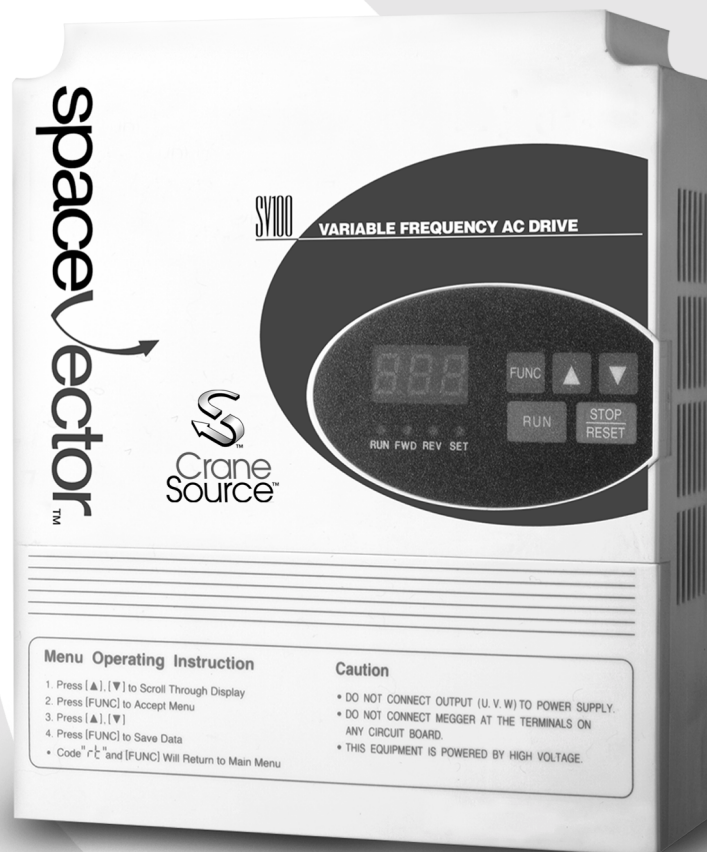

Crane  
Source™

COLUMBUS MCKINNON CORPORATION

Version 2

# SpaceVector™ Variable Frequency Drives

Congratulations on the purchase of a SpaceVector™ SV100 Series drive. This is the most advanced drive on the market today specifically designed and programmed for the overhead material handling industry by the leader in the industry, Columbus McKinnon Corporation.

SpaceVector™ drives have many advantages and features to meet the very specific and demanding needs of the crane and hoist industry. Features such as:

- An energy efficient drive, resulting in less heating of the motor.
- Cooler running motors last longer, saving on downtime and maintenance costs.
- Efficient utilization produces more torque, resulting in better load control.
- Reduced motor harmonics, which improve motor performance and lengthen life.
- Easy macro quick set programming for faster start-up and servicing.
- Plain English programming and service manual saves time.

## IMPORTANT! PLEASE READ!

Before proceeding any further, please read the following important information regarding the drive and its proper handling and use:

- **Please read this manual completely before working with the drive.**
- **The drive operates on and contains high voltage that can cause electric shock resulting in personal injury or loss of life. Handle the drive with the same care and caution as all other high voltage electrical components.**
- **Be sure to disconnect all AC input power to the drive before servicing. Lock and tag the main switch in the de-energized position per ANSI Z 244.1.**
- **Wait at least 3 minutes after disconnecting the AC input power to the drive. If the bus capacitor discharge circuit fails, high voltage can remain in the drive for a period of time after the AC power is disconnected.**
- **Do not perform high voltage tests such as Megger testing.**
- **Only qualified personnel should perform service.**
- **Ensure unit is properly grounded.**
- **Disconnect drive before performing any welding on the bridge crane structure. Do not weld the hook, to the hook or to a load suspended from the hook.**

On the following pages are specification and selection tables for the drives and dynamic braking resistors. Please check to insure you have the proper equipment for your application.

# SV100

## Table Of Contents

Introduction .....	2
<b>Chapter 1: Installation</b>	
Section 1.1: Inspection of Drive .....	6-9
Section 1.2: Mounting the Drive .....	10-14
Section 1.3: Wiring the Drive .....	15-20
<b>Chapter 2: Start Up Programming</b>	
Section 2.1: Keypad Layout .....	22
Section 2.2: Keypad Operation	
2.2.1: Definitions .....	23
2.2.2: Moving through the Program.....	23-29
2.2.3: Changing Control from Pendant to Keypad - Jog Mode .....	30
Section 2.3: Initial Setup Programming	
2.3.1: Programming for a Specific Application .....	31-32
2.3.2: Programming the Speed Selection .....	33-34
2.3.3: Drive Operation Checks .....	35
<b>Chapter 3: Programming</b>	
Section 3.1 Passwords and Group Access Levels	
3.1.1: Passwords .....	38
3.1.2: Entering a Password .....	38
3.1.3: Changing Passwords .....	38
Section 3.2 Programming Function Data .....	41-42
Section 3.3 Establishing Motor Parameters .....	43-44
<b>Chapter 4: Troubleshooting</b>	
Section 4.1 Monitoring Current and Error Codes	
4.1.1 Monitoring Current During Operation in <u>User Level</u> .....	46
Table 4.1.1: Error Code Troubleshooting Table .....	47-48
Section 4.2 Problem Flow Charts.....	49-52
Section 4.3 Testing Power Components .....	53
Section 4.4 Pushbutton Pendant Test .....	54

**Chapter 5: Function Code Information**

Section 5.1 User Level Functions ..... 57-59  
Section 5.2 Service Level Functions ..... 60-70  
Section 5.3 Advanced Level Functions ..... 71-88

**Chapter 6: Maintenance**

Section 6.1 Maintenance ..... 90  
Section 6.2 Precaution ..... 90  
Section 6.3 Routine Inspection ..... 90  
Section 6.4 Visual Inspection ..... 90

**Appendix** ..... 91-93

# **Chapter 1: Installation**

**Section 1.1: Inspection of Drive**

**Section 1.2: Mounting the Drive**

**Section 1.3: Wiring the Drive**

## Section 1.1: Inspection of the Drive

 <b>WARNING</b>
Working in or near exposed energized electrical equipment presents a danger of electric shock.
<b>To Avoid Injury:</b> <ul style="list-style-type: none"><li>• Disconnect and lockout power to the drive per ANSI Z 244.1</li><li>• Wait 3 minutes after disconnecting power for capacitor discharge before entering drive.</li></ul>

1. Inspect the drive for any physical damage that may have occurred during its shipment. If any parts of the drive are missing or damaged, contact your SpaceVector™ distributor immediately.
2. Verify the nameplate of the SV100 drive. Verify that the drive part number matches your order and packing slip.
3. Verify that the Dynamic Braking Resistor part number matches your order and packing slip.
4. If there are any questions reference Tables 1.1.1, 1.1.2, 1.1.3, 1.1.4 for Drive and Resistor specifications.

Table 1.1.1: SV100 Drive Specifications for 230 Volts

<b>SpaceVector™ Drive Specifications (230 V)</b>					
<b>Drive Part No.</b>		<b>446485-01</b>	<b>446485-02</b>	<b>446485-03</b>	<b>446485-04</b>
<b>Drive Model No.</b>		<b>1.2</b>	<b>2.2</b>	<b>3.2</b>	<b>5.2</b>
<b>Rating</b>	Ref.	1 HP	2 HP	3 HP	5 HP
<b>Output Rating</b>	Power	1.9 kVA	2.9 kVA	4.2 kVA	6.1 kVA
	Current	5 Amp	7.5 Amp	11 Amp	16 Amp
	Max. Frequency	120 Hz			
	Voltage	200 - 230 V			
<b>Input Rating</b>	Voltage	200 - 230 V ( $\pm 10\%$ ) - 3 phase			
	Frequency	50 or 60 Hz ( $\pm 5\%$ )			
<b>Control</b>	Method	Space Vector PWM			
	Frequency Resolution	0.01 Hz			
	Frequency Accuracy	Digital setting: 0.01% of Maximum Frequency Analog setting: 0.1% of Maximum Frequency			
	V/F Ratio	Linear and User programmable			
	Braking Torque with DB Resistor	150%			
	Overload Capacity	150% for 1 minute			
	Torque Boost	0 - 20% programmable			
<b>Operation</b>	Method	Key-pad / Terminal Selective			
	Frequency Selection	Keypad / Analog: 0 ~ 10 VDC, 4 ~ 20 mA			
	Accel. /Decel. time	0.1 - 999 sec.			
	Speed Selection	Up to 3 steps, programmable			
<b>Programmable Input</b>	Programmable Input	Three inputs - 2, 3, P			
<b>Protection</b>	Fault Indication	Overload, Overvoltage, Undervoltage, Overcurrent, Inverter overheat, Motor overheat, CPU error, Phase loss			
	Stall Prevention	Overcurrent prevention			
	Instantaneous Power Failure	Under 15 msec: continuous operation Over 15 msec: automatic restart (selective)			
<b>Environmental Conditions</b>	Ambient Temperature	-10° to 40°C (14° to 104°F)			
	Humidity	Under 90% (non-condensing)			
	Altitude	Under 1,000 m (3280 feet)			
	Cooling System	Forced Air			

Table 1.1.2: SV100 Drive Specifications for 460 Volts

<b>SpaceVector™ Drive Specifications (460 V)</b>					
Drive Part No.		446485-05	446485-06	446485-07	446485-08
Drive Model No.		1.4	2.4	3.4	5.4
<b>Rating</b>	Ref.	1 HP	2 HP	3 HP	5 HP
<b>Output Rating</b>	Power	1.9 kVA	3 kVA	4.2 kVA	6.1 kVA
	Current	2.5 Amp	4 Amp	5.5 Amp	8 Amp
	Max. frequency	120 Hz			
	Output volts	380 - 460 V			
<b>Input Rating</b>	Voltage	380 - 460 V (± 10%) - 3 phase			
	Frequency	50 or 60 Hz (± 5%)			
<b>Control</b>	Method	Space Vector PWM			
	Frequency Resolution	0.01 Hz			
	Frequency Accuracy	Digital setting: 0.01% of Maximum Frequency Analog setting: 0.1% of Maximum Frequency			
	V/F Ratio	Linear and User programmable			
	Braking Torque with DB Resistor	150%			
	Overload Capacity	150% for 1 minute			
	Torque Boost	0 - 20% programmable			
<b>Operation</b>	Method	Keypad / Terminal Selective			
	Frequency Selection	Keypad / Analog: 0 ~ 10 VDC, 4 ~ 20 mA			
	Accel. / Decel. time	0.1 - 999 sec.			
	Speed Selection	Up to 3 steps, programmable			
<b>Programmable Input</b>	Programmable Input	Three inputs - 2, 3, P			
<b>Protection</b>	Fault Indication	Overload, Overvoltage, Undervoltage, Overcurrent, Inverter overheat, Motor overheat, CPU error, Phase loss			
	Stall Prevention	Overcurrent prevention			
	Instantaneous Power Failure	Under 15 msec: continuous operation Over 15 msec: automatic restart (selective)			
<b>Environmental Conditions</b>	Ambient Temperature	-10° to 40°C (14° to 104°F)			
	Humidity	Under 90% (non-condensing)			
	Altitude	Under 1,000 m (3280 feet)			
	Cooling System	Forced Air			



Table 1.1.3: 230 V Class Dynamic Braking Resistors

H.P.	Class A, B, C or D Service			Class E Service
	Hoist with MLB*	Hoist without MLB*	Traverse	Hoist without MLB*
1	446485-A1 100 Ω	446485-A1 100 Ω	446485-A1 100 Ω	446485-A1 100 Ω
2	446485-A2 50 Ω	446485-A8 60 Ω	446485-A2 50 Ω	446485-A8 60 Ω
3				
5	446485-A4 33 Ω	446485-B3 30 Ω	446485-A4 33 Ω	446485-B3 30 Ω

\*MLB = Mechanical Load Brake

Table 1.1.4: 460 V Class Dynamic Braking Resistors

H.P.	Class A, B, C or D Service			Class E Service
	Hoist with MLB*	Hoist without MLB*	Traverse	Hoist without MLB*
1	446485-A0 200 Ω	446485-A0 200 Ω	446485-A0 200 Ω	446485-A0 200 Ω
2		446485-A5 200 Ω		446485-A5 200 Ω
3		446485-B0 200 Ω		446485-B0 200 Ω
5	446485-A1 100 Ω	446485-B2 120 Ω	446485-A3 130 Ω	446485-B2 120 Ω

\*MLB = Mechanical Load Brake

## Section 1.2: Mounting the Drive

### 1.2.1 Environmental Conditions

1. Verify the ambient condition of the drive mounting location. The ambient temperature range should be 14° to 104°F (-10° to 40°C) for NEMA 1 and or NEMA 4/12 enclosures.
2. The relative humidity should be less than 90% (non-condensing), below the altitude of 3280 ft or 1000 m.
3. Do not mount the drive in direct sunlight. The drive should also be isolated from excessive vibration.
4. The drive should be protected from moisture, dust, metallic particles, corrosive gases and liquids.
5. Consult Factory for severe environments.

### 1.2.2 Electrical Conditions

1. Verify that Input voltage is within drive nameplate +/- 10%. If input line voltage varies due to sags and / or surges input line reactors are recommended.
2. Analog input requires individually shielded twisted pair cable for installations where the cable leaves the control cabinet.
3. If length of motor leads between drive and motor exceed 100 ft. (30 m) a load reactor between drive and motor is recommended.

### 1.2.3 Mounting

The SV100 must be mounted vertically with sufficient space (horizontally and vertically) between adjacent equipment. See Figure 1.2.1. See Figures 1.2.2 – 1.2.4 for actual drive dimensions.

Fig. 1.2.1: Recommended Clearances for Drive Mounting

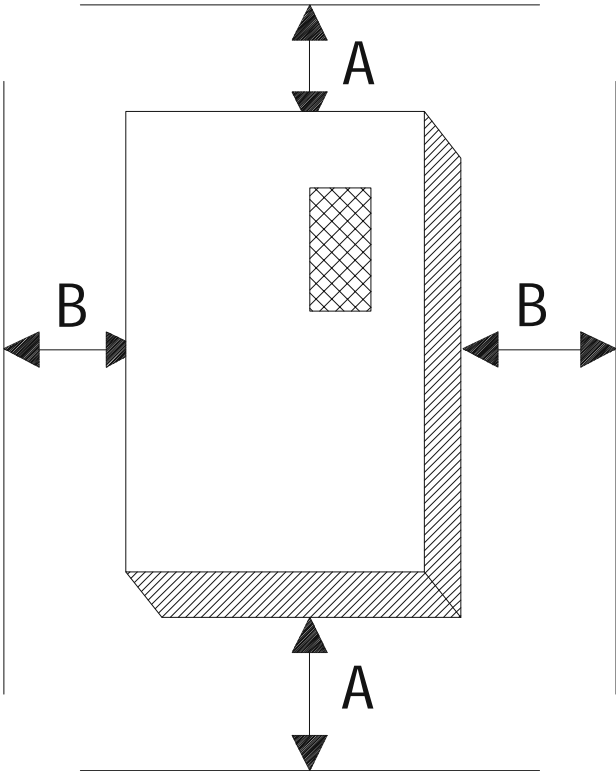

A: over 6.0" (15cm)  
B: over 2.0" (5cm)

**Note:** Allow more room between drive and other heat producing components (such as transformers and drive ballast resistors) than shown in Fig. 1.2.1. These components radiate enough heat to damage the drive and its internal components.

## Drive Dimensions and Weights

Fig. 1.2.2: SV100 Part Nos. 446485-01 / 446485-02 4.6lbs/5.1lbs  
(2.1kg/2.3kg)

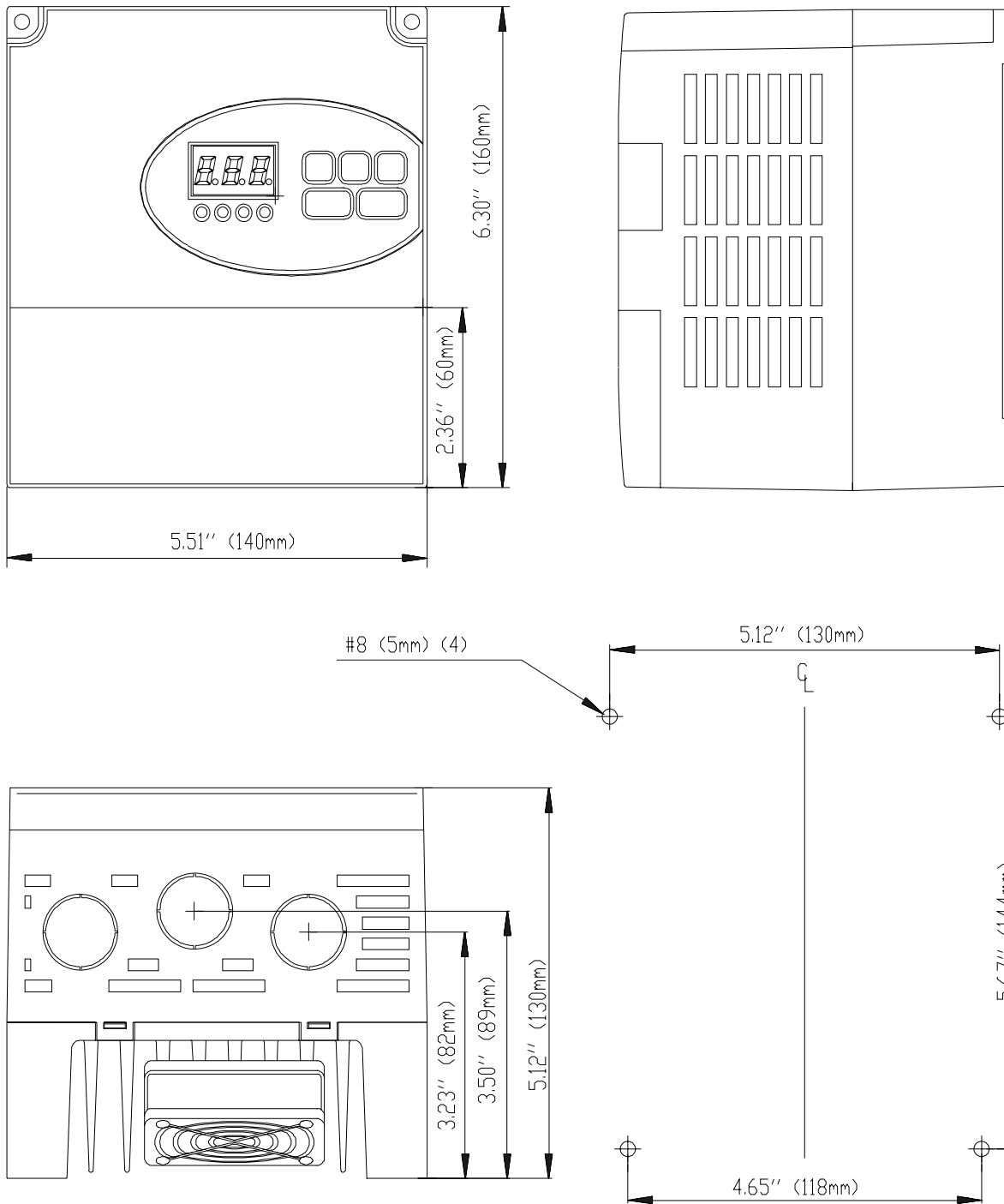

Fig. 1.2.3: SV100 Part Nos. 446485-03 / 446485-04 7.1lbs / 7.7lbs  
 446485-05 / 446485-06 (3.2kg/3.5kg)

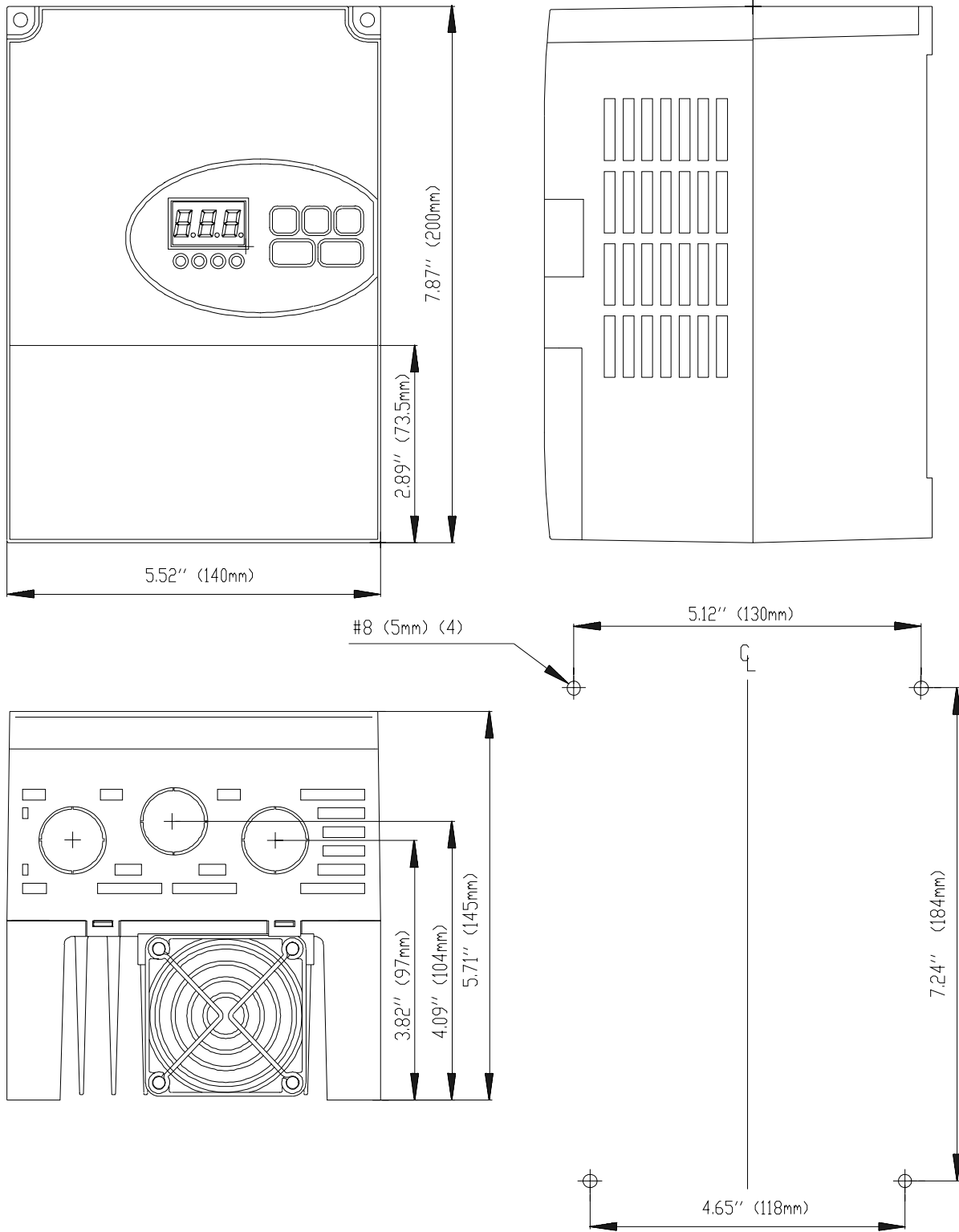
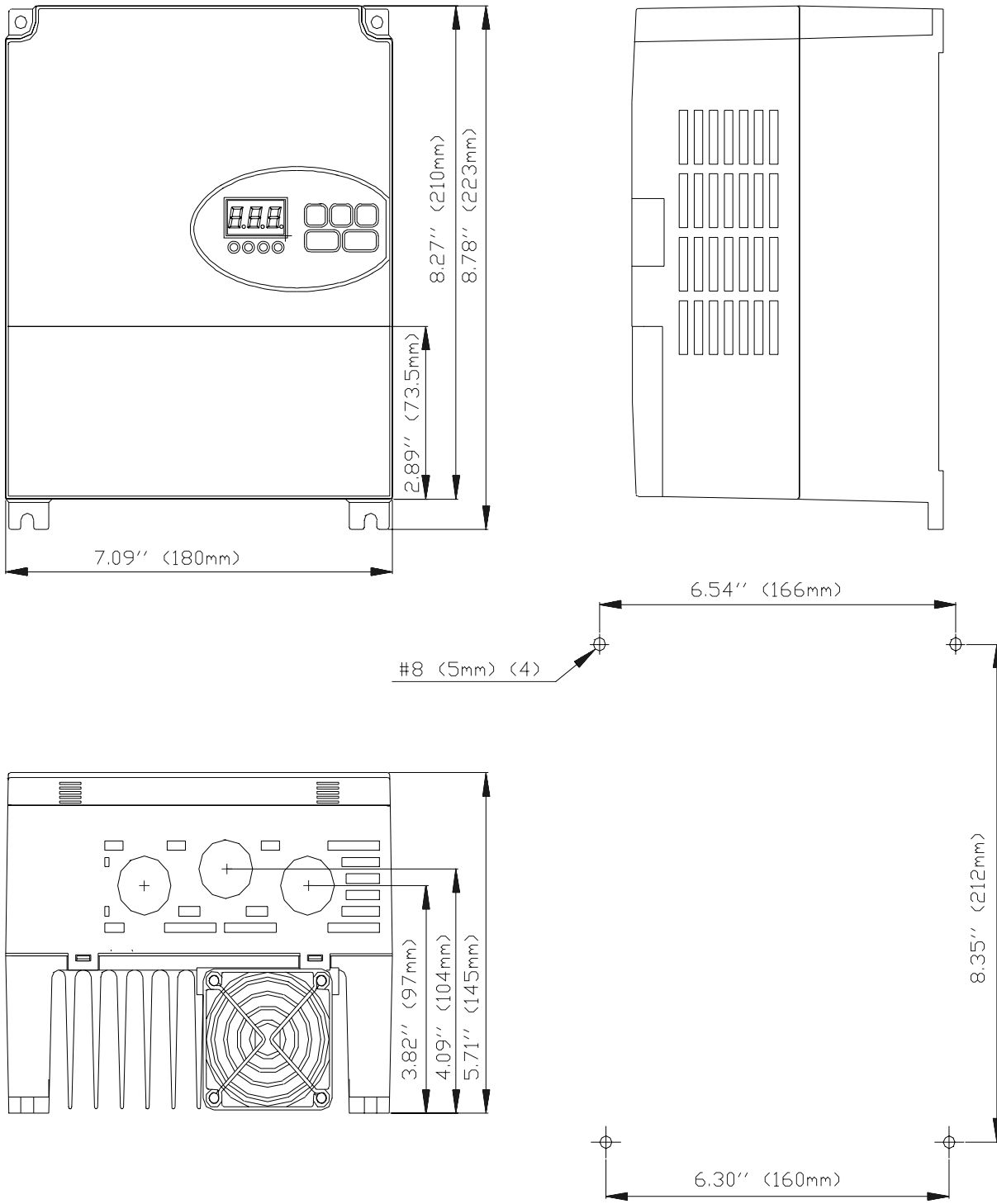

Fig. 1.2.4: SV100 Part Nos. 446485-07 / 446485-08 7.7lbs(3.5kg)



## Section 1.3: Wiring the Drive

### 1.3.1 Remove Cover From Drive

Figure 1.3.1 below is a reference for the basic Input / Output Terminals of a 460 VAC SV100 drive. 230 VAC Models are wired the same.

Fig. 1.3.1: SV100 Layout For Basic Wiring

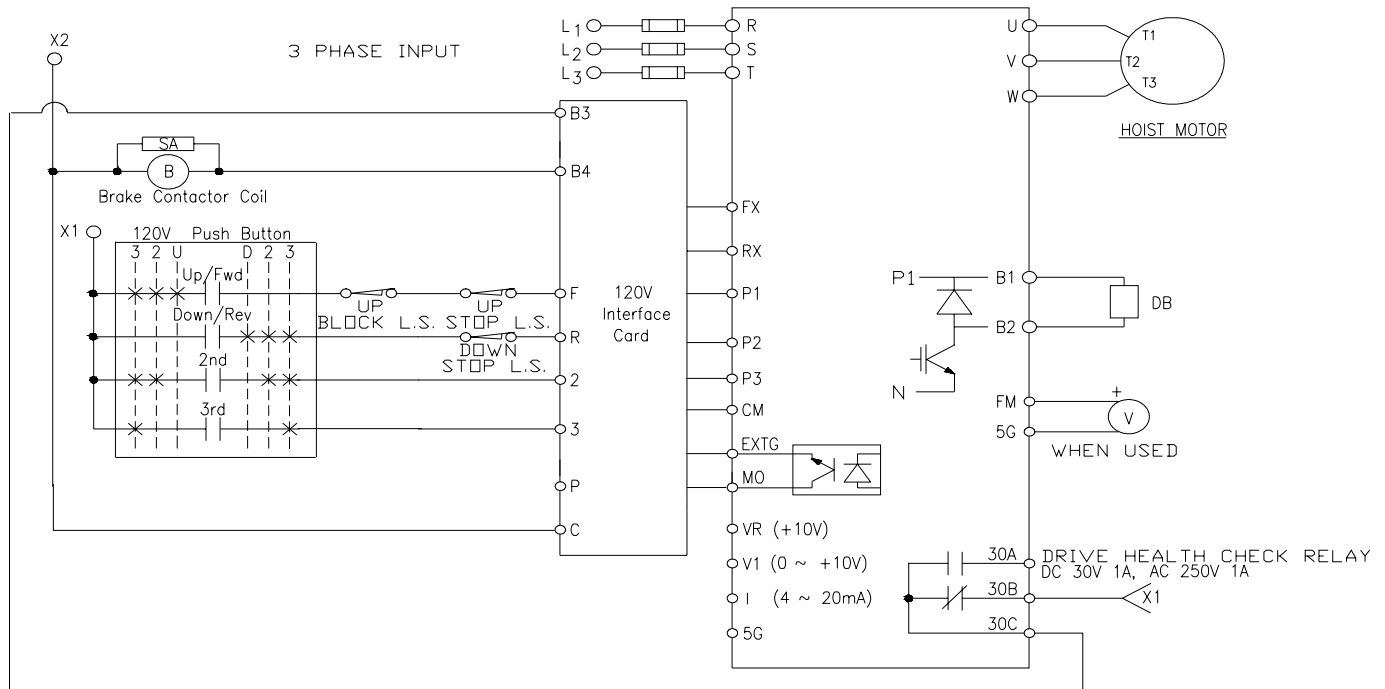

Drawings representative of other configurations are located in the Appendix.

### 1.3.2 Check For Correct Wire Gauges

Insure the correct wire gauges for the input and output power leads are being used before wiring the drive. Use Table 1.3.1 for reference.

Table 1.3.1: Wire Gauge Reference Table.

SV100 Drive Class	Drive Rated Amp.	Input AWG	Output AWG	Ground AWG	DB Resistor AWG	Control AWG
230V Class	5.0	12	12	12	12	16
	7.5					
	11			10	10	
	16					
460V Class	2.5	12	12	12	12	16
	4					
	5.5					
	8					

### 1.3.3 Fuse and Circuit Breaker Selection

Reference Table 1.3.2 to properly apply fuses and circuit breakers to the drive.

Table 1.3.2: Fuse and Circuit Breaker Selection

SV100 Drive Voltage	Ref. HP	SV100 Part Number	Fuse Rating Class (J)	Molded Case Circuit Breaker
230V	1	446485-01	10 A	15 A
	2	446485-02	10 A	15 A
	3	446485-03	20 A	25 A
	5	446485-04	25 A	30 A
460V	1	446485-05	5 A	5 A
	2	446485-06	8 A	10 A
	3	446485-07	10 A	15 A
	5	446485-08	15 A	20 A

### 1.3.4 Power Lead Wiring

Use Figure 1.3.2 as shown below to assist in wiring the power leads to the drive.

Fig. 1.3.2: Input / Output Power and Dynamic Braking Resistor Wiring Diagram.

#### Arrangement of Power Terminal Strip

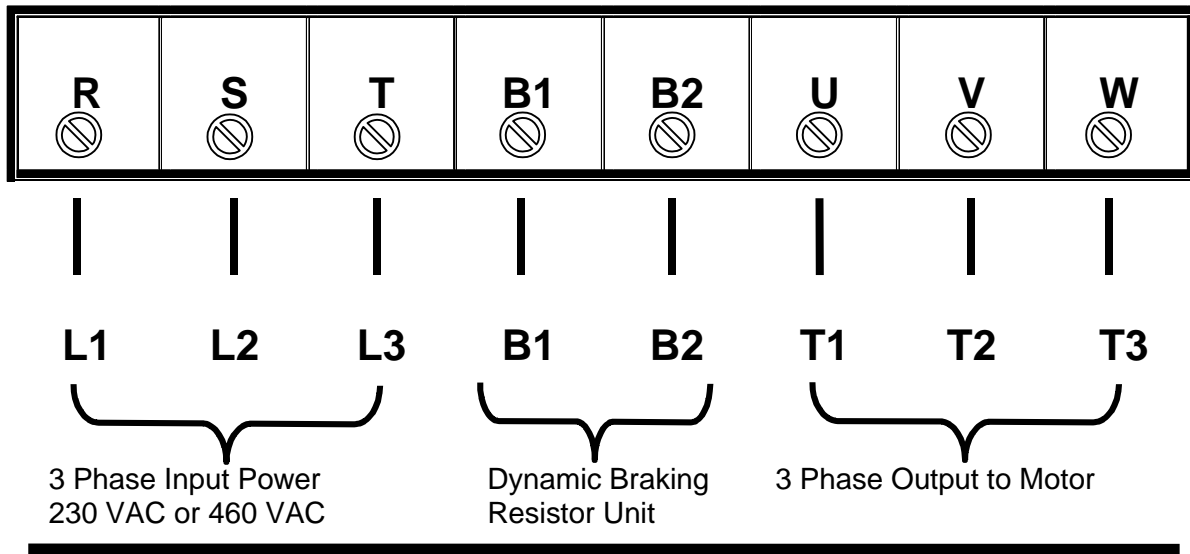

**Note 1:** Slotted Tongue Terminals are recommended for connections shown in Figure 1.3.2.

**Note 2:** Use drive chassis to ground the drive to the panel.



### 1.3.5 Wire the Dynamic Braking Resistor

Use Figure 1.3.3 as shown below to assist in wiring the dynamic braking resistor to the power terminal strip.

Fig. 1.3.3: Power Terminal Strip Connection for the Dynamic Braking Resistor

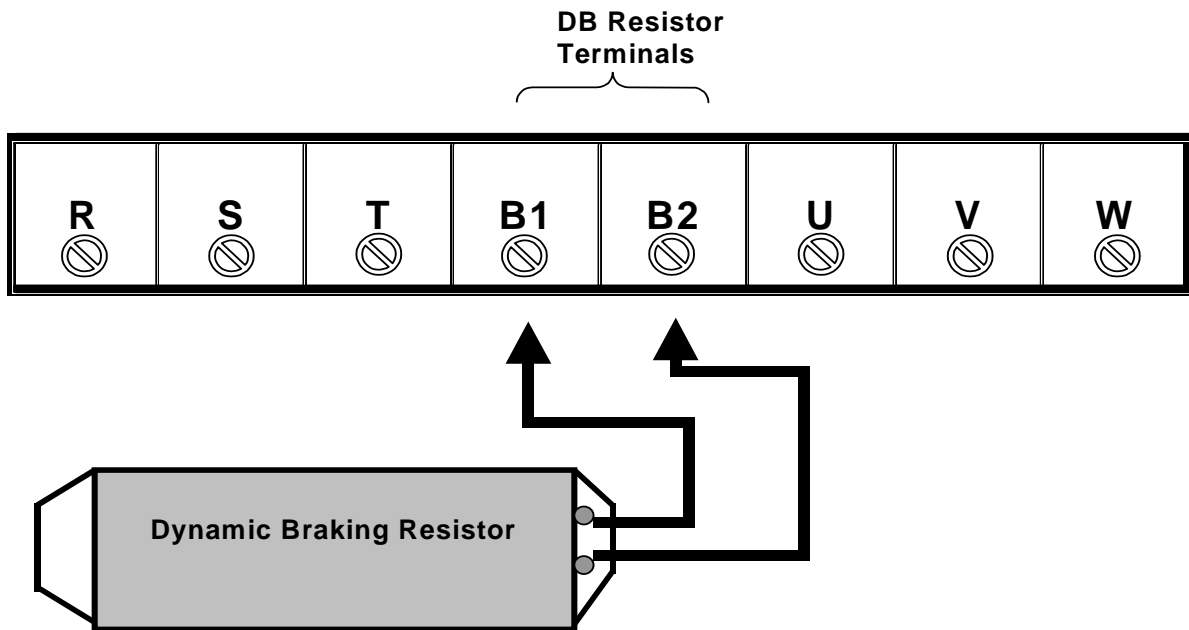

#### **CAUTION! OBSERVE CAUTION AS RESISTOR MAY BE HOT!**

- The Dynamic Braking Resistors dissipate the motor rotational energy in the form of heat. They are required for all hoist and traverse applications.
- If the dynamic braking resistor has a bad connection or is missing, the drive DC Bus voltage may increase, resulting in an overvoltage fault.
- The dynamic braking resistor generates a lot of heat during its operation. Place the resistor where it may dissipate this energy without damaging other components.

### 1.3.6 Interface Card Connection

The SV100 SpaceVector™ Drive comes equipped with the 120 VAC Interface Card installed. Fig. 1.3.4 below shows the connection of the interface card to the control terminal strip.

Fig. 1.3.4: Interface Card Connection to the Control Terminal Strip

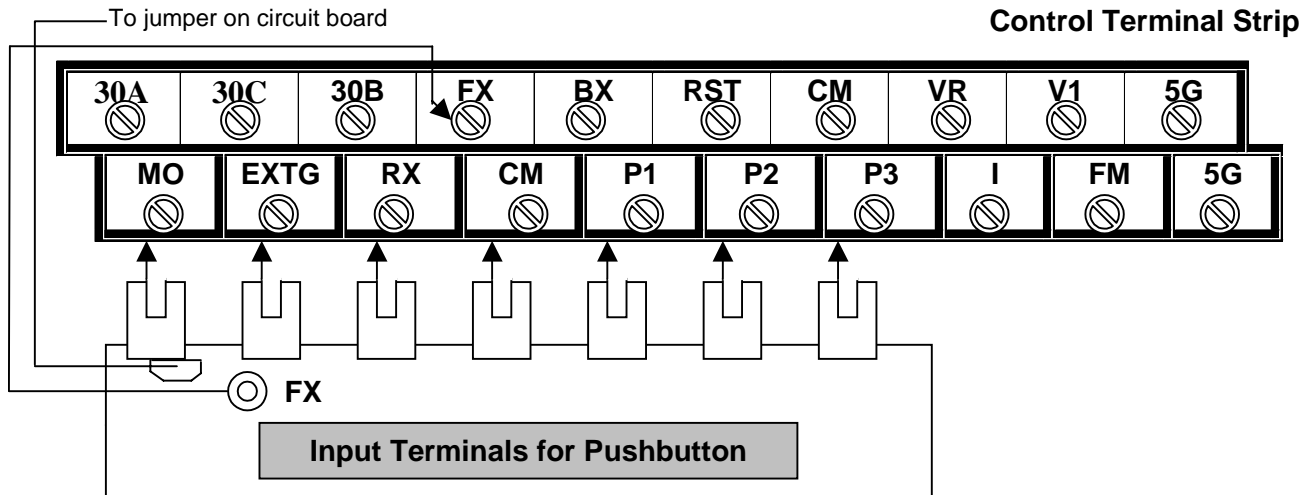

### 1.3.7 Connect the Pushbutton Pendant Control Wires

Wire the pushbutton pendant control to the pendant input terminals. See Fig. 1.3.5 below for wiring diagram. Once the pendant is wired, check to determine that the motor turns in the correct direction with respect to the pendant button pressed. Consult Chapter 4 Troubleshooting for help if there is a problem.

**Note:** The Interface Card requires 120 VAC input signal from your external pushbutton.

Fig. 1.3.5: Pushbutton Wiring Diagrams for the Original and Revised Versions

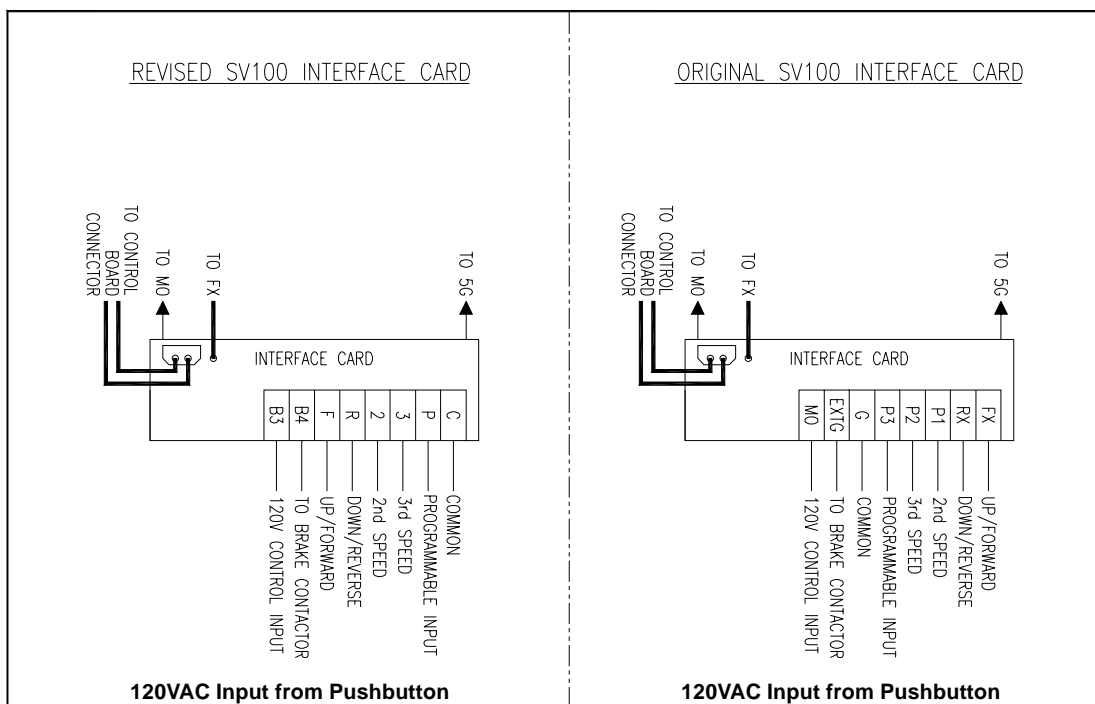

### 1.3.8 Control Wire Description

Reference the control wiring terminal in Figure 1.3.6 below and the descriptions of each terminal listed in Tables 1.3.4 and 1.3.5.

Fig. 1.3.6: Control Wiring Terminal

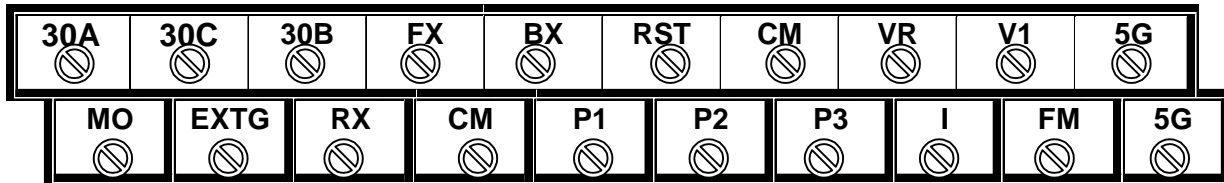

Table 1.3.4: Most common drive control terminals used.

Symbol	Function
<b>FX</b>	Up / Forward direction command terminal Speed 1 [F on 120VAC Interface Card Input Terminal]
<b>RX</b>	Down / Reverse direction command terminal Speed 1 [R on 120VAC Interface Card Input Terminal]
<b>MO</b>	Multifunction output terminal for brake release [B3 on 120VAC Interface Card Input Terminal]
<b>EXTG</b>	Common terminal for [MO] [B4 on 120VAC Interface Card Input Terminal]
<b>P1</b>	Speed 2 [2 on 120VAC Interface Card Input Terminal]
<b>P2</b>	Speed 3 [3 on 120VAC Interface Card Input Terminal]
<b>P3</b>	Programmable Input [P on 120VAC Interface Card Input Terminal]
<b>CM</b>	Common terminal for [FX], [RX], [BX], [P1], [P2], [P3], [RST] [120VAC Interface Card Input Terminal]

Table 1.3.5: Drive control terminals used for special applications.

Symbol	Function
<b>V1</b>	Analog Speed Reference Input Terminal (0 ~ +10 VDC) (Potentiometer connection terminal)
<b>VR</b>	Voltage power supply for V1 terminal (+11 VDC) (Potentiometer connection terminal)
<b>I</b>	Current speed reference input terminal (4 ~ 20 mA)
<b>FM</b>	Multi-Meter Output Terminal for External Current, Voltage, Frequency Monitoring. [+24 VDC Max. 50mA Max.]
<b>5G</b>	Common terminal for [V1], [I], [FM], [Potentiometer connection terminal]
<b>BX</b>	Emergency stop command terminal
<b>RST</b>	Fault reset command terminal
<b>30A</b>	Relay output terminal (Normal open contact) [DC 30V, AC 250V, 1A]
<b>30B</b>	Relay output terminal (Normal close contact) [DC 30V, AC 250V, 1A]
<b>30C</b>	Relay output terminal (Common terminal) [DC 30V, AC 250V, 1A]

### 1.3.9 Make Precautionary Checks Before Operation

1. Make sure the input voltage level to the drive is correct. Refer to the Drive Specification Tables 1.1.1 and 1.1.2.
2. Check the power and control connections. All wires should be connected tightly to the terminal.
3. Check the 120VAC source for the control push button.
4. The length of the output wires between the SV100 and the motor must not exceed 100 feet.
5. Check the drive and motor ground and make sure there is no ground loop problem. Ensure that all motors and drives connected from a common panel are connected to a single ground point. See Fig. 1.3.7 for an example.

Fig. 1.3.7 Ground Connection Comparison

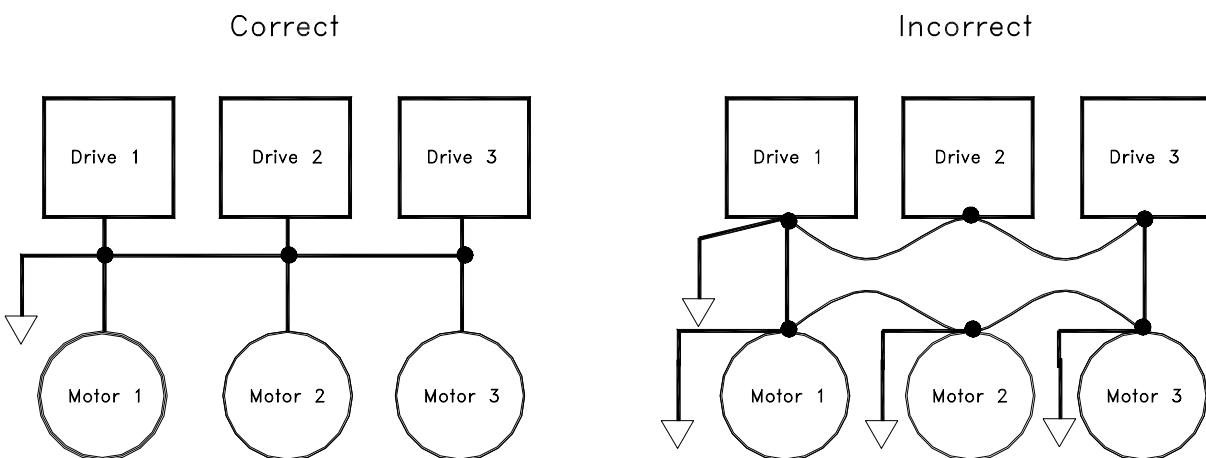

# **Chapter 2: Start Up Programming**

## **Section 2.1: Keypad Layout**

## **Section 2.2: Keypad Operation**

### **2.2.1: Definitions**

### **2.2.2: Moving Through the Program**

### **2.2.3: Changing Control from Pendant to Keypad**

## **Section 2.3: Initial Setup Programming**

### **2.3.1: Programming for a Specific Application**

### **2.3.2: Programming the Speed Selection**

### **2.3.3: Drive Operation Checks**

## Section 2.1: Keypad Layout

The SV100 keypad consists of an LED display, status lights, and keys for easy programming. Fig. 2.1.1 below illustrates the layout of the SV100 keypad.

Figure 2.1.1 – SV100 keypad layout

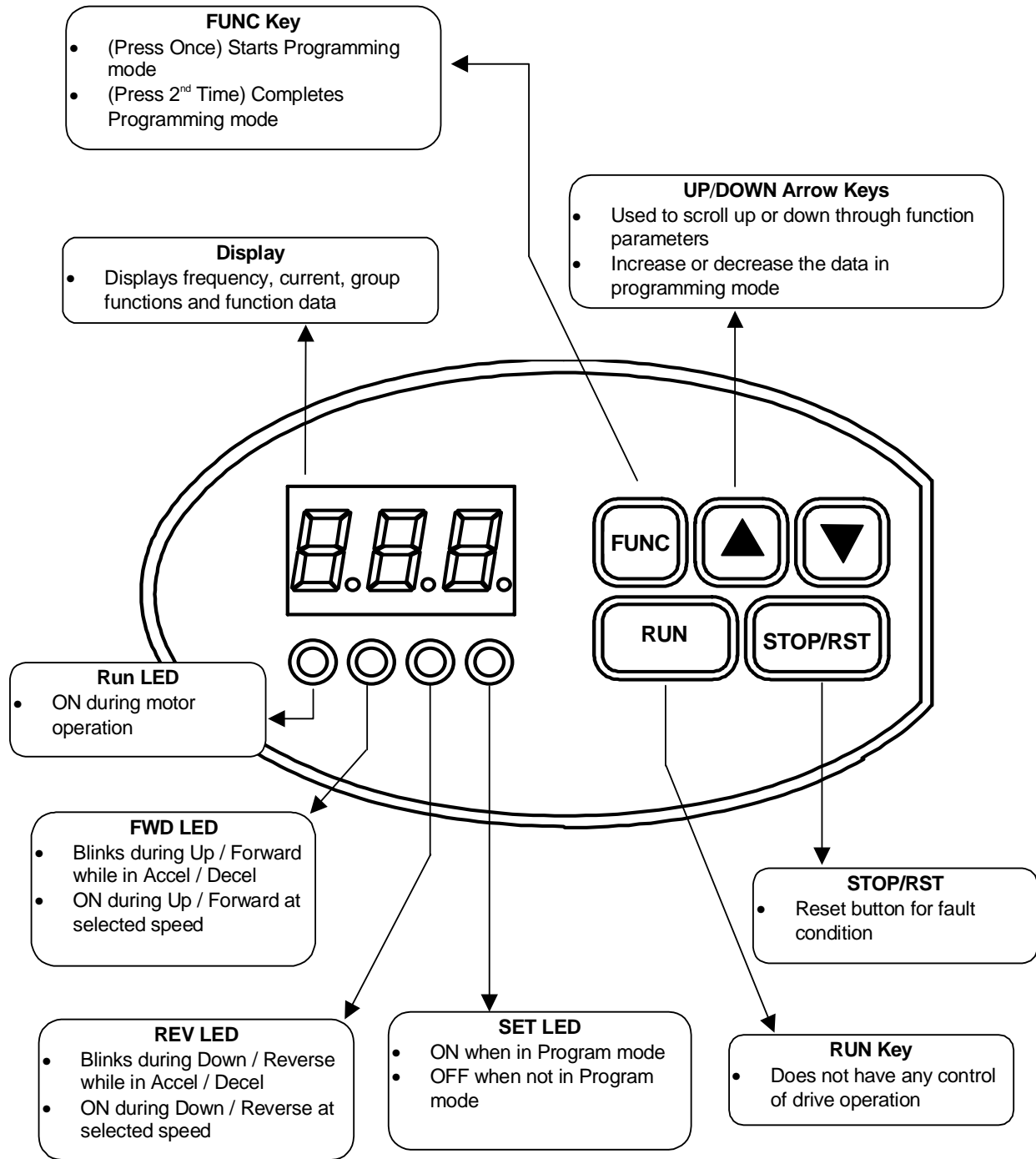

## Section 2.2: Keypad Operation

Keypad operation and moving through the parameters of each access level is a straightforward process. First read the definitions below.

### 2.2.1 Definitions

**Levels** – The SV100 program consists of three levels. The levels are the User, Service, and Advanced. Each level consists of different function commands which control how the drive operates, senses, and performs.

**User Level** – This level allows programming speed, passwords, and the motion application desired. You can also monitor motor current draw and system faults in this level.

**You are automatically in the User level upon power up of your drive.**

**Service Level** (FU1 on SV100 Display) – The functions within this group primarily set how the drive will perform, sense problems, and set parameters catered to your motor for peak operation.

**Advanced Level** (FU2 on SV100 Display) – Functions within this level are reserved for special performance characteristics and consists of advanced performance parameters.

### 2.2.2 Moving Through The Program

When the drive is first powered up, the first Function Code of the User Level is displayed. Please follow the keypad button prompts illustrated in Fig. 2.2.1: Programming Flowchart and use Table 2.2.1: Function Code List for all levels to help follow program flow.





Table 2.2.1: Function Code List For All Levels

Level	Func. No.	Display	Description	Range	Default
User	1	0	Speed 1 frequency displayed when in stop mode Actual frequency output displayed during run mode	0 - F9 Hz	10.0 Hz
	2	mac (Mac)	Motion Define 0: Traverse 1: Hoist with Load Brake 2: Hoist without Load Brake	0 - 2	1
	3	sos	Speed Selection 0: 2 Speed 1: 2 Step Infinitely Variable 2: 3 Speed 3: 3 Step Infinitely Variable	0 - 3	1
	4	cur	Displays Output RMS Current		
	5	sp2	Speed 2	0 - F9 Hz	60.00 Hz
	6	sp3	Speed 3		0.00 Hz
	7	acc	Acceleration Time	0 - 999 sec.	3.0 sec.
	8	dec	Deceleration Time		
	9	lsp	Low Speed when Limit Switch NC Contact is Open	0 - User Fcn. 1	5.0 Hz
	10	f1 (Ft1)	Fault Display	OC, Ov, OLt, OH, EtH, PHF, Lv, bX, CPU	
	11	f2 (Ft2)	Displays Previous Fault to [User No. 10]		
	12	f3 (Ft3)	Displays Previous Fault to [User No. 11]		
	13	inp	Displays Status of Input Terminal R, F, B4, P, 3 and 2		
	14	acl	Displays Permitted Access Level USr: User level SEr: Service Level Adv: Advanced Level		
	15	pas	Enter Password	0 - 999	0
	16	pa1	Change Service Level Password		
	17	pa2	Change Advanced Level Password		
	18	fu1	Service Level Function Codes		
	19	fu2	Advanced Level Function Codes		
	20	jog (JOG)	Jog is displayed only when F1 (Run/Stop Command) is set to "0" (Keypad)	Step, Up, Dn	
	21	ver (VER)	Software Version		H2C
Service	1	f1	RUN/STOP Mode 0: Keypad 1: Terminal	0 or 1	1
	2	f2	Acceleration Pattern 0: Linear 1: S Curve	0 or 1	1

Table 2.2.1: Function Code List For All Levels (cont.)

Level	Func. No.	Display	Description	Range	De fault
Service	3	F3	Deceleration Pattern 0: Linear 1: S Curve	0 or 1	0
	4	F4	Define Multi-Function Input, [2] NOTE: Macro Setup for Speed Step sets these inputs automatically. 0: Speed 2 1: Speed 3 2: Reserved 3: Frequency Increasing (UP) 4: Fequency Hold 5: Immediate Stop Limit Switch (LS) Input 6: Ramp to Stop LS - Not recommended for hoist motion 7: Low Speed LS (User Function No. 9)	0 - 7	3
	5	F5	Define Multi-Function Input, [3] NOTE: Macro Setup for Speed Step sets these inputs automatically. 0: Speed 2 1: Speed 3 2: Reserved 3: Frequency Increasing (UP) 4: Fequency Hold 5: Immediate Stop Limit Switch (LS) Input 6: Ramp to Stop LS - Not recommended for hoist motion 7: Low Speed LS (User Function No. 9)	0 - 7	2
	6	F6	Define Multi-Function Input, [P] NOTE: Macro Setup for Speed Step sets these inputs automatically. 0: Speed 2 1: Speed 3 2: Reserved 3: Frequency Increasing (UP) 4: Fequency Hold 5: Immediate Stop Limit Switch (LS) Input 6: Ramp to Stop LS - Not recommended for hoist motion 7: Low Speed LS (User Function No. 9)	0 - 7	2
	7	F7	Multi-Function Output 0: Frequency reaching time (Normally Closed) 1: Frequency reaching time (Normally Open) 2: Stall Operation Signal (H26, H27) 3: Overload Signal (H28, H29) 4: Under-voltage (LV fault) Signal 5: Run/Stop Signal	0 - 5	1
	8	F8	Drive model selection preset at factory. If reference horse power setting change is necessary, see Section 5.2.5 for the cross reference between drive models and drive part numbers		Drive Model No.
	9	F9	Maximum Frequency of Operation	40.0 - 120 Hz	60.0 Hz
	10	F0	Rated Frequency of Motor (Base Frequency)	40.0 - F9 Hz	60.0 Hz
	11	F11	Drive Cutoff Frequency	0.01 - 5.0 Hz	0.5 Hz
	12	F12	Starting Dwell Frequency	0.0 - F9 Hz	3.0 Hz
	13	F13	Starting Dwell Time Initial Values: Hoist = 0.5 sec. Traverse = 0.1 sec.	0.1 - 10.0 sec.	0.5 sec.
	14	F14	V/F Pattern Selection 0: Linear 1: Reserved - <b>Do not use.</b> 2: User V/F	0 or 2	0

Table 2.2.1 - Function Code List For All Levels (cont.)

Level	Func. No.	Display	Description	Range	Default
Service	15	F5	Set Torque Boost during Up / Forward Run	0 - 20%	5%
	16	F6	Set Torque Boost during Down / Reverse Run	0 - 20%	2%
	17	F7	Output Voltage Adjustment	50 - 110%	100%
	18	F8	Brake Release Frequency - Frequency Reaching Signal Setting (FDT Frequency) FDT Freq. = Starting Dwell Freq. + 0.01 Hz. (Default)	0.01 - F9 Hz	3.01 Hz
	19	F9	Frequency Reaching Signal Band Setting	0.0 - 30.0 Hz	0.0 Hz
	20	F20	Stop Mode 0: Ramp to Stop - Not recommended for hoist motion 1: DC Injection Braking 2: Immediate Stop 3: Delay on Brake	0 - 3	2
	21	F21	Brake Delay Time	0.0 - 25.0 sec.	0.0 sec.
	22	F22	Parameter Read from Main Memory to Keypad	0 or 1	0
	23	F23	Parameter Write from Keypad to Main Memory	0 or 1	0
	24	F24	Set Parameters to Default Factory Setting 0: Inactive 1: Active	0 or 1	0
	25	F25	Lock Changing Parameters	U0 - U99	
	26	F26	Return to User Group		
	Advanced Warning: This level is Recommended for Trained SpaceVector™ Service personnel only.	1	H1	Command Frequency Selection Method 0: Keypad 1: Analog	0 or 1
2		H2	User V/F Frequency 1 (See Service Function F14)	0.0 - F9 Hz	5.0 Hz
3		H3	User V/F Voltage 1 (See Service Function F14)	0 - 100%	16%
4		H4	User V/F Frequency 2 (See Service Function F14)	0.0 - F9 Hz	30.0 Hz
5		H5	User V/F Voltage 2 (See Service Function F14)	0 - 100%	50%
6		H6	Analog Input Mode 0: Voltage Input (0 ~ 10V) 1: Current Input (4 ~ 20mA) 2: Voltage + Current Input	0 - 2	0
7		H7	Analog Input Filter Gain	1 - 200%	100%
8		H8	Analog Input Gain	50 - 100%	
9		H9	Analog Input Bias	0 - 100%	5%
10		H0	Analog Input Direction 0: Direct 1: Inverse	0 or 1	0
11		H11	Maximum Operating Frequency	0.0 - F9 Hz	60.0 Hz
12		H12	Minimum Operating Frequency		
13		H13	Frequency to Bypass	0.0 - F9 Hz	0.0 Hz
14		H14	Frequency Band to Bypass	0.0 - 30.0 Hz	
15		H15	DC Braking Frequency	0.0 - 20.0 Hz	5.0 Hz
16		H16	DC Braking Voltage	0 - 20.0%	5%
17		H17	DC Braking Block Time	0.0 - 5.0 sec.	0.5 sec.
18		H18	DC Braking Time	0.0 - 20.0 sec.	2.0 sec.
19		H19	Slip Compensation 0: Inactive 1: Active	0 or 1	0
20		H20	Rated Motor Slip (See Section 3.3)	0.0 - 5.0 Hz	3.0 Hz

Table 2.2.1 - Function Code List For All Levels (cont.)

Level	Func. No.	Display	Description	Range	Default
<b>Advanced</b> Warning: This level is Recommended for trained SpaceVector™ Service personnel only.	21	H21	Rated Motor Current (See Section 3.3)	0.1 - 60.0 A	See Table 5.2.2
	22	H22	No Load Motor Current (See Section 3.3)		
	23	H23	Retry Number	0 - 10	0
	24	H24	Retry Time	0.0 - 10.0 sec.	0.5 sec.
	25	H25	Retry Mode 0: Non-operation during LV Fault and Retry 1: Non-operation during LV Fault 2: Non-operation during Retry 3: Driving in all Faults	0 - 3	0
	26	H26	Stall Prevention Mode <b>DO NOT USE ON HOIST MOTION. FOR TRAVERSE MOTION WITH DB RESISTOR DO NOT USE VALUES 4 THROUGH 7.</b> Hoist Initial Value = 0 Traverse Initial Value = 1 0: Disable 1: During Acceleration 2: During Steady Speed 3: During Acceleration and Steady Speed 4: During Deceleration 5: During Acceleration and Deceleration 6: During Deceleration and Steady Speed 7: During Accel, Decel, and Steady Speed	0 - 7	0
	27	H27	Stall Level	30 - 150%	150%
	28	H28	Over-load Level (see Service Function F7)	30 - 150%	150%
	29	H29	Over-load Time (see Service Function F7)	0.1 - 30.0 sec.	10.0 sec.
	30	H30	Over Current Limit Time (OLT) Hoist Initial Value = 0.1 sec. Traverse Initial Value = 30.0 sec.	0.0 - 60.0 sec.	0.1 sec.
	31	H31	EtH (Motor Electronic Thermal Detection) 0: Inactive 1: Active	0 or 1	0
	32	H32	EtH Level	30 - 150%	150%
	33	H33	Motor Type 0: General 1: Special (Forced Air Cooling)	0 or 1	0
	34	H34	IPF (Instantaneous Power Failure) Restart Hoist Initial Value = 0 Traverse Initial Value = 1 0: Inactive 1: Active	0 or 1	0
	35	H35	Speed Search Acceleration Time	0.1 - 10.0 sec.	2.0 sec.
	36	H36	Speed Search Deceleration Time		
	37	H37	Speed Search Block Time	0.0 - 5.0 sec.	0.0 sec.
	38	H38	Reset Restart 0: Inactive 1: Active	0 or 1	0
	39	H39	Power On Start 0: Inactive 1: Active	0 or 1	1
	40	H40	Carrier Frequency	3 - 15 kHz	3 kHz
	41	H41	Reserved		0
	42	H42	Reserved		0
	43	H43	Reserved		0
	44	H44	Reserved		0
	45	H45	Reserved		0
	46	H46	Multi-Meter Mode 0: Frequency 1: Output Voltage 2: Output Current	0 - 2	0
	47	H47	Multi-Meter Adjustment	0 - 120%	100%

Table 2.2.1 - Function Code List For All Levels (cont.)

Level	Func. No.	Display	Description	Range	Default
<b>Advanced</b> Warning: This level is Recommended for trained SpaceVector™ Service personnel only.	48	H48	AVR (Automatic Voltage Regulator) 0: Inactive 1: Active	0 or 1	0
	49	H49	Phase Loss Check Time (0 msec. to disable Phase Loss Check)	0 - 5000 msec.	50 msec.
	50	H50	Reverse Plugging Enable - <b>DO NOT USE ON HOIST MOTION</b> 0: Inactive 1: Active	0 or 1	0
	51	H51	Reverse Plugging Acceleration Time	0.0 - 999 sec.	1.5 sec.
	52	H52	Reverse Plugging Deceleration Time		
	53	i e	Return to User Level		

### 2.2.3 Changing Control from Pendant to Keypad - Jog Mode

The SV100 comes preset with pendant control. If the user wishes to change to keypad control, refer to Figure 2.2.2 below. Use Table 2.2.1: Function Table for All Levels for reference.

Fig. 2.2.2 – Flowchart showing how to change from pendant control to keypad control.

- Changing control mode from pendant to keypad is done in F1 of the **Service Level**. Assuming you are in the **User Level**, follow the flowchart.

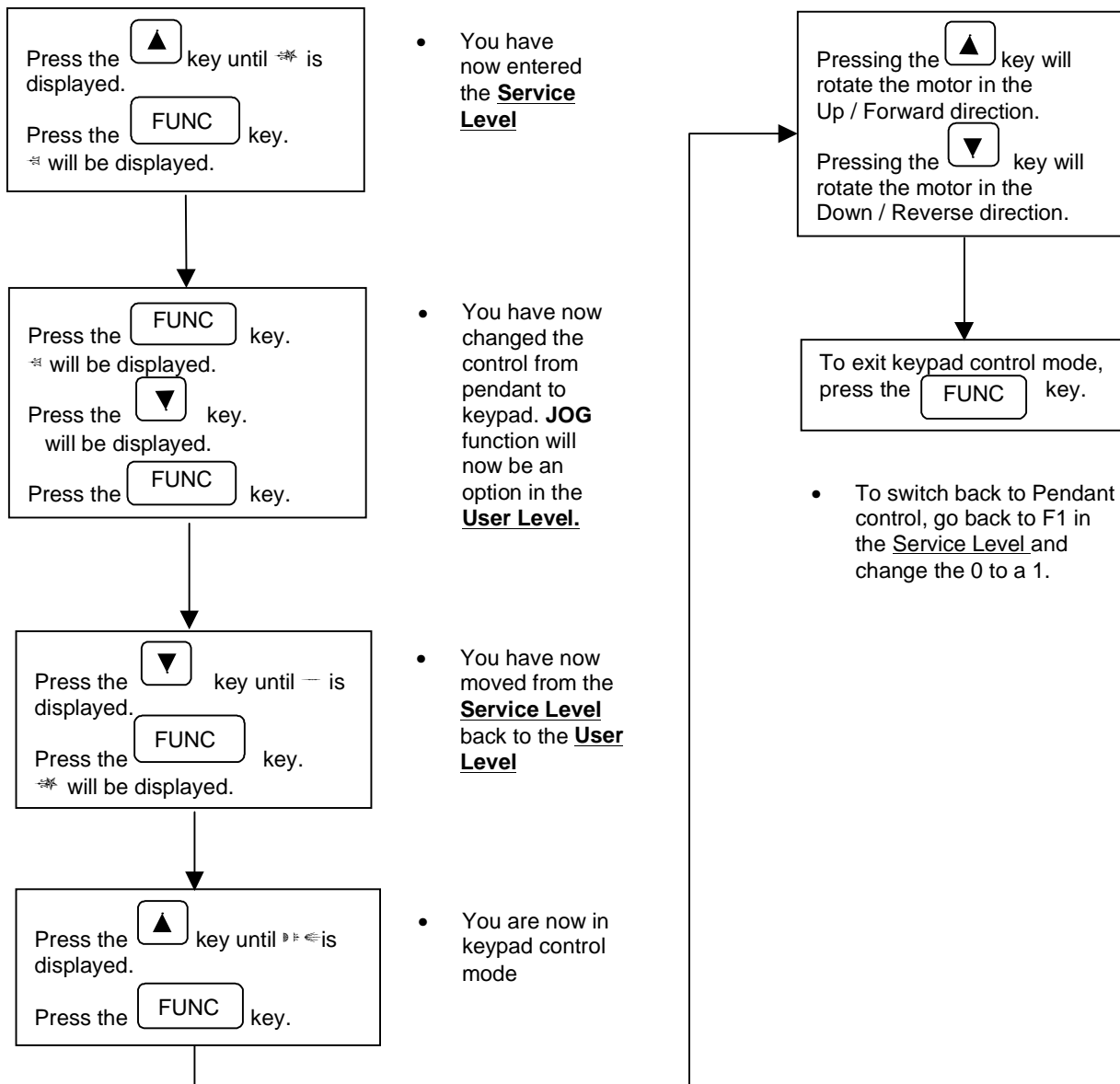

## Section 2.3: Initial Setup Programming

### 2.3.1 Programming the Drive for a Specific Application

Initial setup programming involves a few easy steps. Follow the instructions shown in Figure 2.3.1 below and your drive will be ready for operation.

Fig. 2.3.1: Programming Application Flowchart

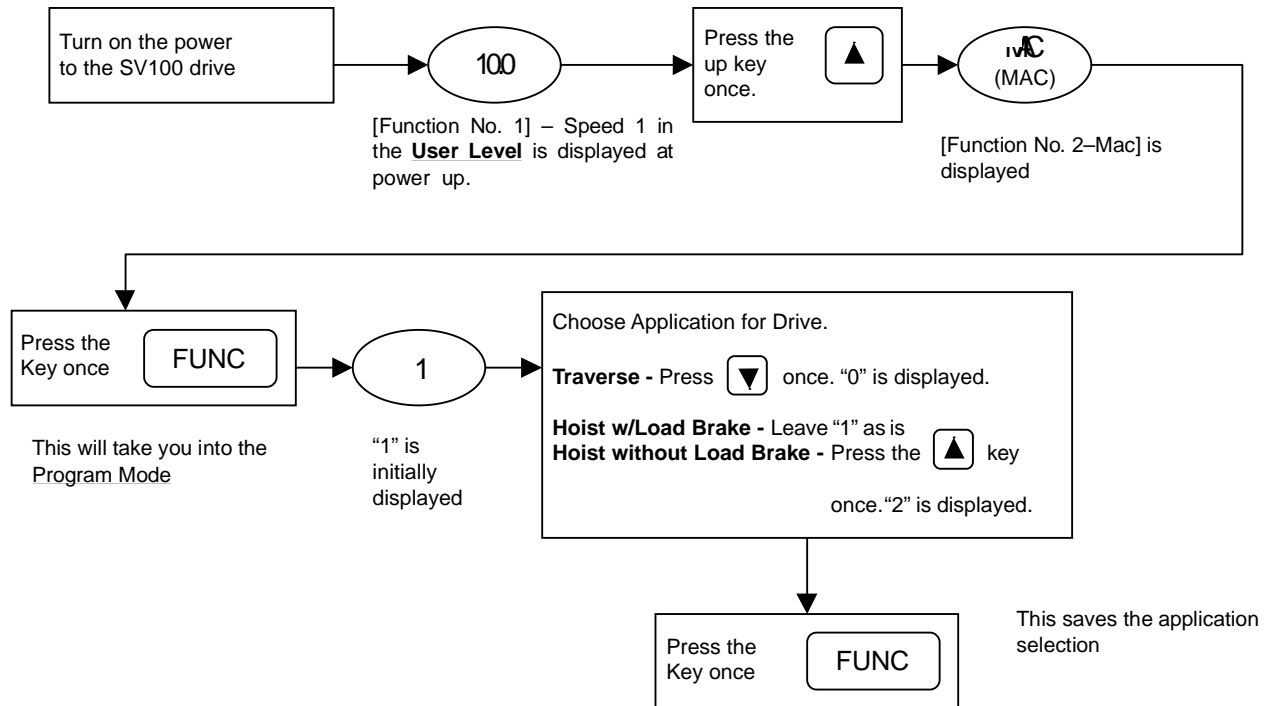

\* The drive has now been programmed for its appropriate application. According to your new selection, other related drive parameters have conveniently changed automatically for quick programming.

See Table 2.3.1 for the function parameters that are affected by the above Macro Quick Set procedure.

**Note:** If so desired, these values can be changed individually by entering the respective access level and changing the function data to customize the drive to your specific application.

Table 2.3.1: Automatic Macro Settings For Application Selection (User Function 2)  
**Macro Set-Up for Traverse (Motion Definition “0”)**

Access Level	Code No.	Display	Description	Initial Data
User	3	S&S	Speed Selection	1: 2 Step Infinitely Variable
	7	ACC	Acceleration Time	3.0 sec.
	8	ΔEC	Deceleration Time	3.0 sec.
Service	2	F2	Acceleration Pattern	1: S Curve
	3	F3	Deceleration Pattern	1: S Curve
	12	F2	Starting Dwell Frequency	3.0 Hz
	13	F8	Starting Dwell Time	0.1 sec.
	18	F8	Brake Release Frequency	3.01 Hz
	20	F20	Stop Mode	0: Ramp to Stop
Advanced	26	H26	Stall Prevention Mode	1: During Acceleration
	30	H80	Overcurrent Limit Time	30.0 sec.
	34	H84	IPF Restart	1: Active
	50	H50	Reverse Plugging Enable	0: Inactive

**Macro Set-Up for Hoist W/ Load Brake (Motion Definition “1”)**

Access Level	Code No.	Display	Description	Initial Data
User	3	S&S	Speed Selection	1: 2 Step Infinitely Variable
	7	ACC	Acceleration Time	3.0 sec.
	8	ΔEC	Deceleration Time	3.0 sec.
Service	2	F2	Acceleration Pattern	1: S Curve
	3	F3	Deceleration Pattern	0: Linear
	12	F2	Starting Dwell Frequency	3.0 Hz
	13	F8	Starting Dwell Time	0.5 Hz
	15	F5	Forward Torque Boost	5%
	16	F6	Reverse Torque Boost	2%
	20	F20	Brake Release Frequency Stop Mode	3.01 Hz 2: Immediate Stop
Advanced	26	H26	Stall Prevention Mode	0: Disable
	30	H80	Overcurrent Limit Time	0.1 sec.
	34	H84	IPF Restart	0: Inactive
	50	H50	Reverse Plugging Enable	0: Inactive

**Macro Set-Up for Hoist W/O Load Brake (Motion Definition “2”)**

Access Level	Code No.	Display	Description	Initial Data
User	3	S&S	Speed Selection	1: 2 Step Infinitely Variable
	7	ACC	Acceleration Time	3.0 sec.
	8	ΔEC	Deceleration time	3.0 sec.
Service	2	F2	Acceleration Pattern	0: Linear
	3	F3	Deceleration Pattern	0: Linear
	12	F2	Starting Dwell Frequency	3.0 Hz
	13	F8	Starting Dwell Time	0.5 sec.
	15	F5	Forward Torque Boost	5%
	16	F6	Reverse Torque Boost	2%
	20	F20	Brake Release Frequency Stop Mode	3.01 Hz 2: Immediate Stop
Advanced	26	H26	Stall Prevention Mode	0: Disable
	30	H80	Overcurrent Limit Time	0.1 sec.
	34	H84	IPF Restart	0: Inactive
	50	H50	Reverse Plugging Enable	0: Inactive

**NOTE:** Typically, these settings will be appropriate for most applications however, they may be customized by using the functions of the User, Service and Advanced Levels.



### 2.3.2 Programming the Speed Selection

The last step for initial setup programming is selecting the speed for the respective application. Follow the flowchart shown in Figure 2.3.2 below.

Fig. 2.3.2: Speed selection flowchart

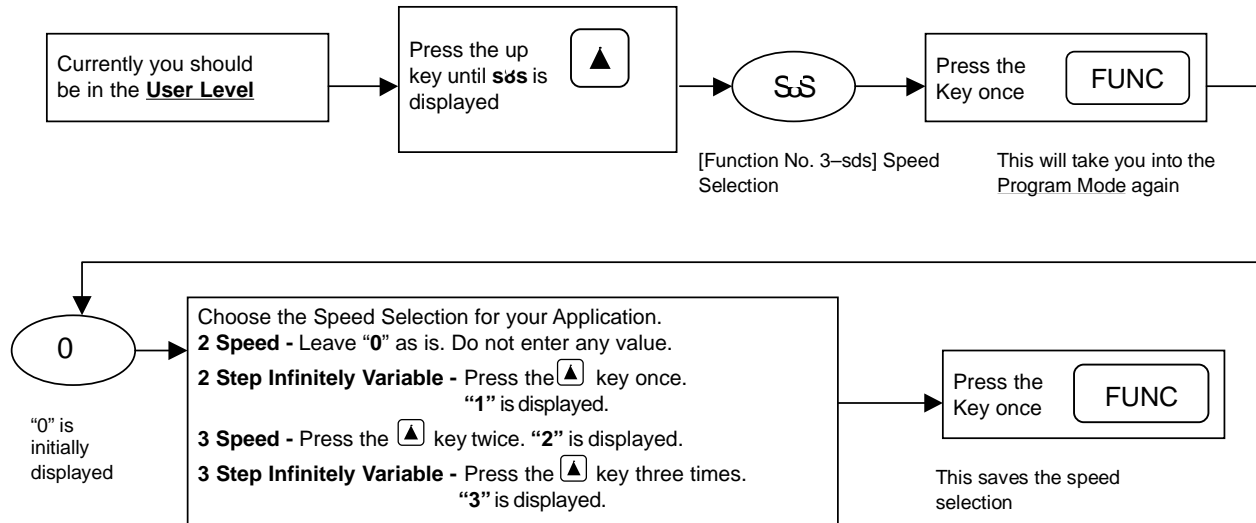

\* The drive has now been programmed for its push button speed command. According to your new selection, other related drive parameters have also changed automatically for quick programming. See Table 2.3.2 for a list of parameters that have automatically changed.

Table 2.3.2: Parameters Affected With Speed Selection Programming.

## 2 Speed

Access Level	Code No.	Display	Description	Initial Data
User	1	0	Speed 1	10 Hz.
	5	SP2	Speed 2	60 Hz.
	6	SP3	Speed 3	0 Hz.
Service	4	F4	Multi-Function Input "2"	0: Speed 2
	5	F5	Multi-Function Input "3"	2: Reserved
	6	F6	Multi-Function Input "P"	2: Reserved
	7	F7	Multi-Function Output	1: Freq. Reaching Time (N.O.)

## 2 Step Infinitely Variable

Access Level	Code No.	Display	Description	Initial Data
User	1	0	Speed 1	10 Hz.
	5	SP2	Speed 2	60 Hz.
	6	SP3	Speed 3	0 Hz.
Service	4	F4	Multi-F unction Input "2"	3: Freq. Increasing
	5	F5	Multi-F unction Input "3"	2: Reserved
	6	F6	Multi-Function Input "P"	2: Reserved
	7	F7	Multi-Function Output	1: Freq. Reaching Time (N.O.)

## 3 Speed

Access Level	Code No.	Display	Description	Initial Data
User	1	0	Speed 1	10 Hz.
	5	SP2	Speed 2	30 Hz.
	6	SP3	Speed 3	60 Hz.
Service	4	F4	Multi-Function Input "2"	0: Speed 2
	5	F5	Multi-Function Input "3"	1: Speed 3
	6	F6	Multi-Function Input "P"	2: Reserved
	7	F7	Multi-Function Output	1: Freq. Reaching Time (N.O.)

## 3 Step Infinitely Variable

Access Level	Code No.	Display	Description	Initial Data
User	1	0	Speed 1	10 Hz.
	5	SP2	Speed 2	30 Hz.
	6	SP3	Speed 3	60 Hz.
Service	4	F4	Multi-F unction Input "2"	4: Freq. Hold
	5	F5	Multi-F unction Input "3"	3: Freq. Increasing
	6	F6	Multi-Function Input "P"	2: Reserved
	7	F7	Multi-Function Output	1: Freq. Reaching Time (N.O.)

**NOTE:** The three speeds may be changed individually in the **User level** if so desired.

\*The drive is now ready to run.

In the Appendix are timing graphs representing the different speed control options. To set up the drive operation for Analog control see section 5.3.3.

### **2.3.3 Drive Operation Checks**

1. Test drive with an unloaded hoist.
2. Make sure the hoist electric motor brake is operating properly.
3. Run the hoist or traverse, and verify its correct operation in relation to direction of movement versus pendant button pressed.
4. Check all limit switches for correct operation.

If the drive operates incorrectly please follow the troubleshooting charts of this manual, or contact your SpaceVector™ Dealer for further assistance.

This page intentionally left blank.

# **Chapter 3: Programming**

## **Section 3.1: Passwords and Group Access Levels**

### **3.1.1: Passwords**

### **3.1.2: Entering a Password**

### **3.1.3: Changing Passwords**

## **Section 3.2: Programming Function Data**

## **Section 3.3: Establishing Motor Parameters**

## Section 3.1: Passwords and Group Access Level

### 3.1.1 Passwords

The SV100 allows you to program up to two passwords. The purpose of a password is to prevent people from inadvertently changing important parameters found in the **Service and Advanced Levels**. In order to change parameters in the **Service or Advanced Levels**, you must first enter a password designated to the respective level. The **User Level** does not require a password to change parameters.

When you first receive your drive, the programming permission level is initially setup for the **Advanced Level**. This means you can program parameters in all levels. The initial password for all levels is (0). To help explain how passwords affect programming permission levels, see Figure 3.1.1.

### 3.1.2 Entering a Password

When you first receive the SV100 drive, the initial password for all levels is (0). To help explain how specific passwords affect each permission level of programming, follow Figure 3.1.1. It is assumed that the initial password of (0) has been changed to a (1) for **Service Level** and a (2) for **Advanced Level**. If a password change is desired, see Changing a Password, in Section 3.1.3 of this manual.

### 3.1.3 Changing a Password

If a password change is desired in either the **Service Level** or the **Advanced Level**, reference Figure 3.1.2.

**Caution:** Once you change your password, make sure it is written down where it can be referenced at a later time if necessary.

Fig. 3.1.1: Flowchart explanation for entering a password and its affect on programming permissions.

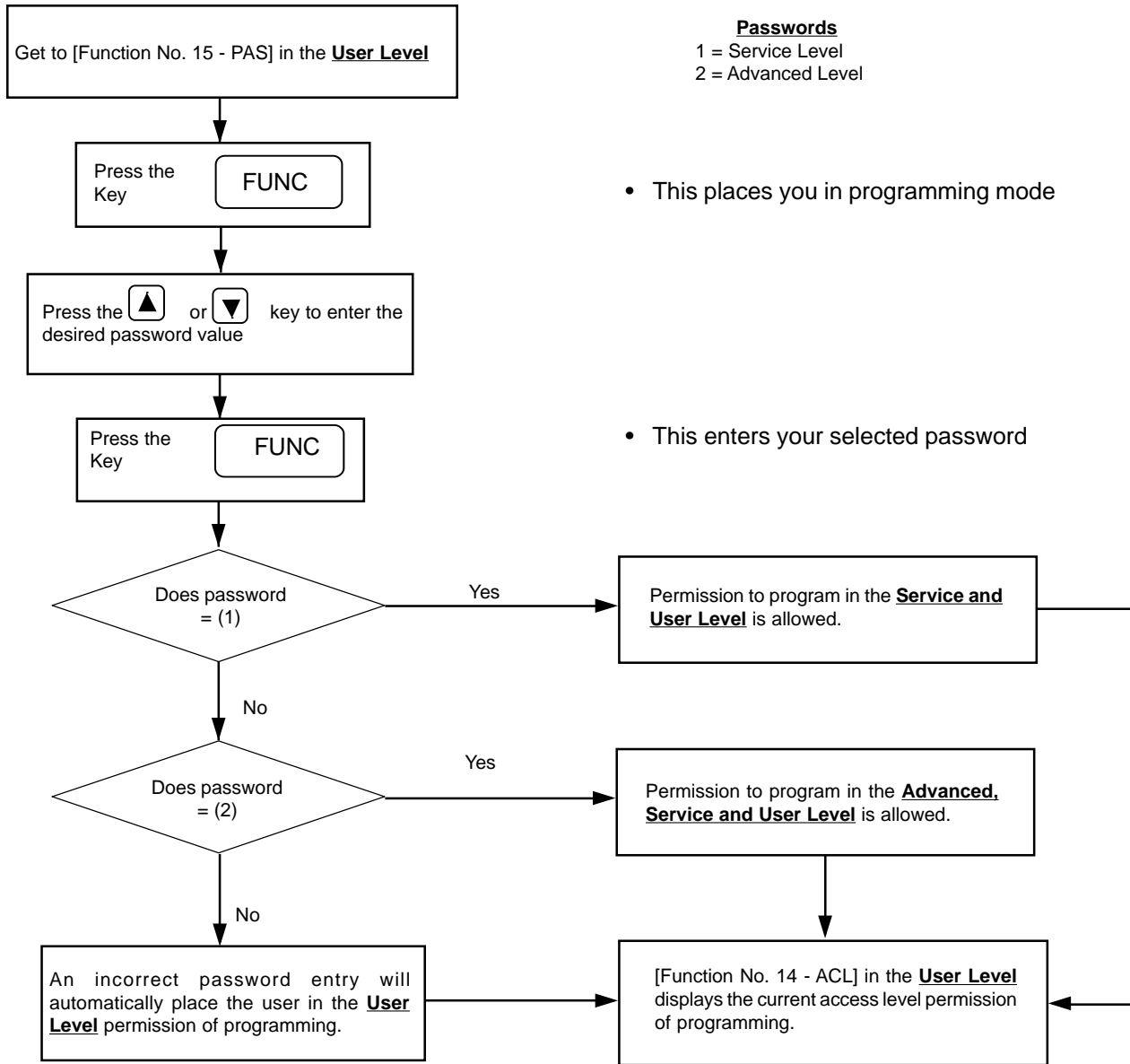
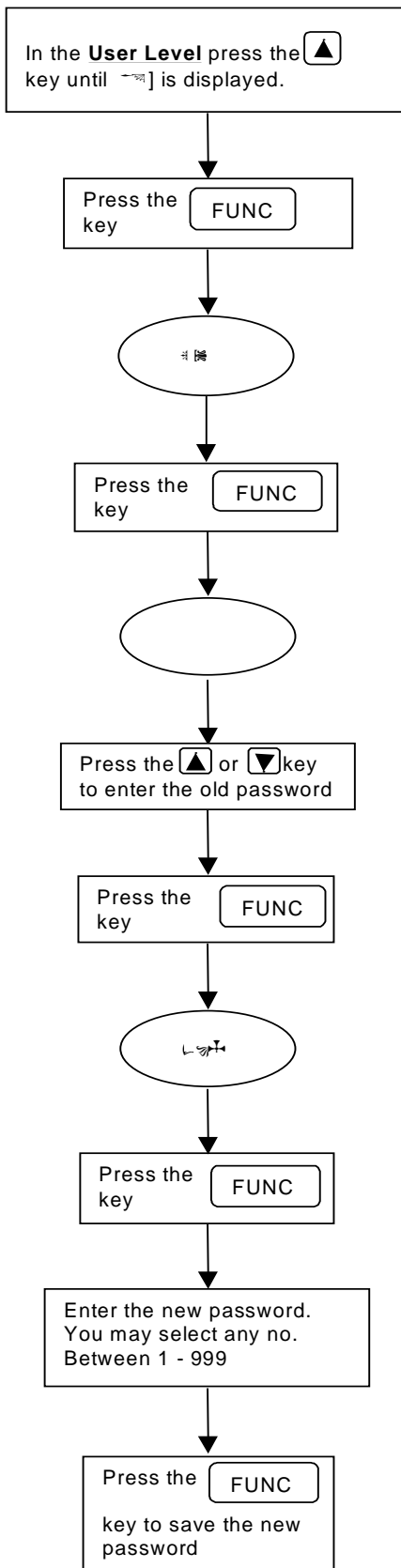
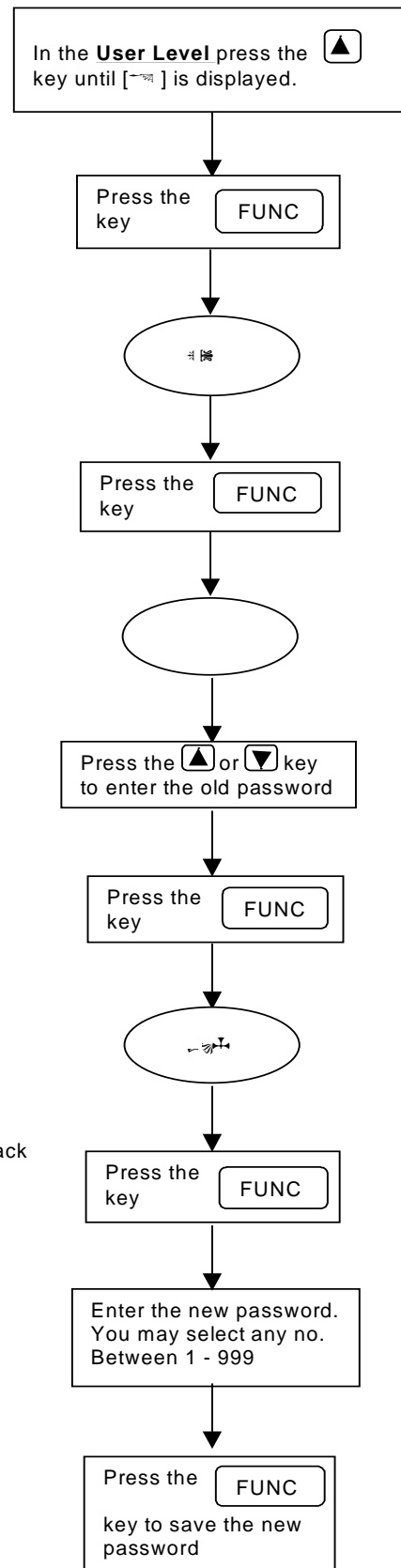

Fig. 3.1.2: Flowchart for changing passwords.

Changing the **Service Level** Password



Changing the **Advanced Level** Password



If you enter the wrong password, you will go back to [PA1] or [PA2], depending on which function you are in.



## Section 3.2: Programming Function Data

### 3.2.1 Customizing the Programming

Changing function data requires a few short steps. A password is required for changing any function data in the **Service** or **Advanced Levels**. Changing data in the **User Level** does not require a password. Figure 3.2.1 demonstrates how to change function data in all levels.

Fig. 3.2.1: Changing function data in all levels.

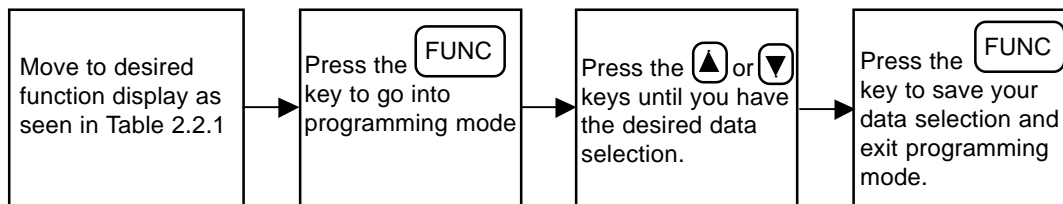

Below are a few examples of how to change function data. Use Table 2.2.1 for reference.

#### Example 1:

Fig. 3.2.2: Change Speed 2 from 60.0 Hz. to 40.2 Hz.

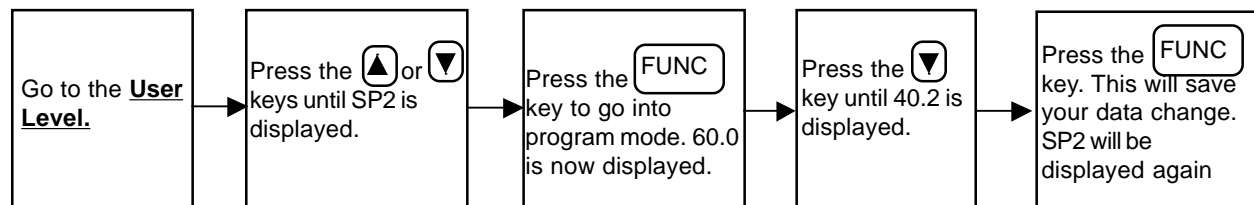

#### Example 2:

Fig. 3.2.3: Store drive parameters into keypad.

Assume that you are currently in the **User Level** and you have not entered a password.

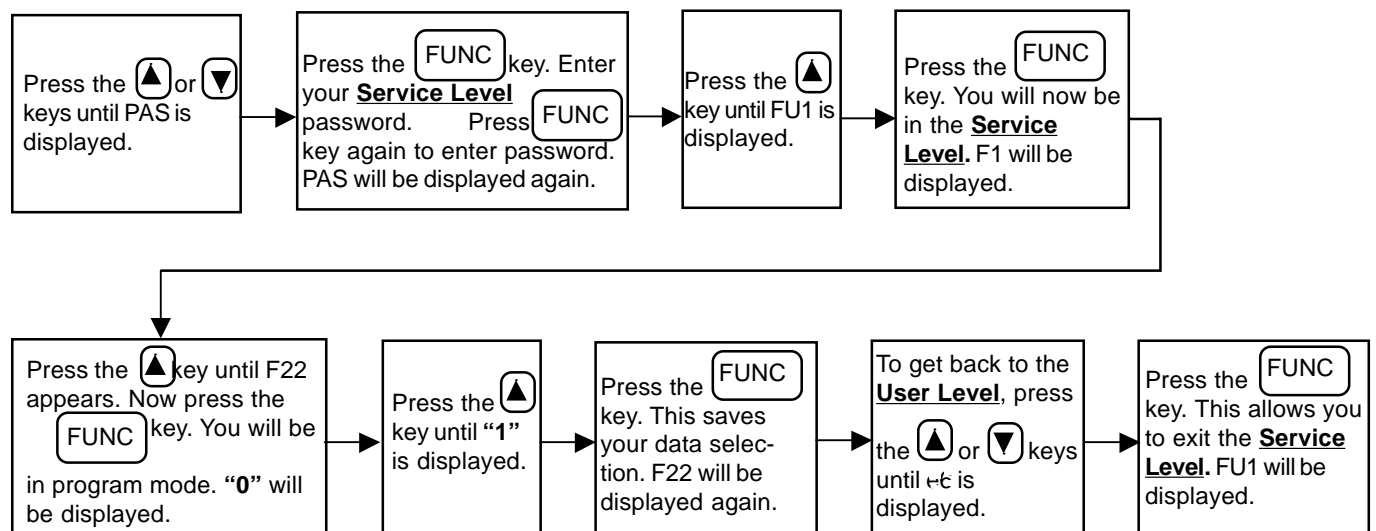

**Caution:** The next example shows how to change data in the Advanced Level. It is recommended that only trained SpaceVector™ service personnel change data in this level.

**Example 3:**

Fig. 3.2.4: Change the rated slip of the motor from 3.0 Hz to 2.5 Hz.

Assume that you are currently in the **User Level** and you have not entered any password.

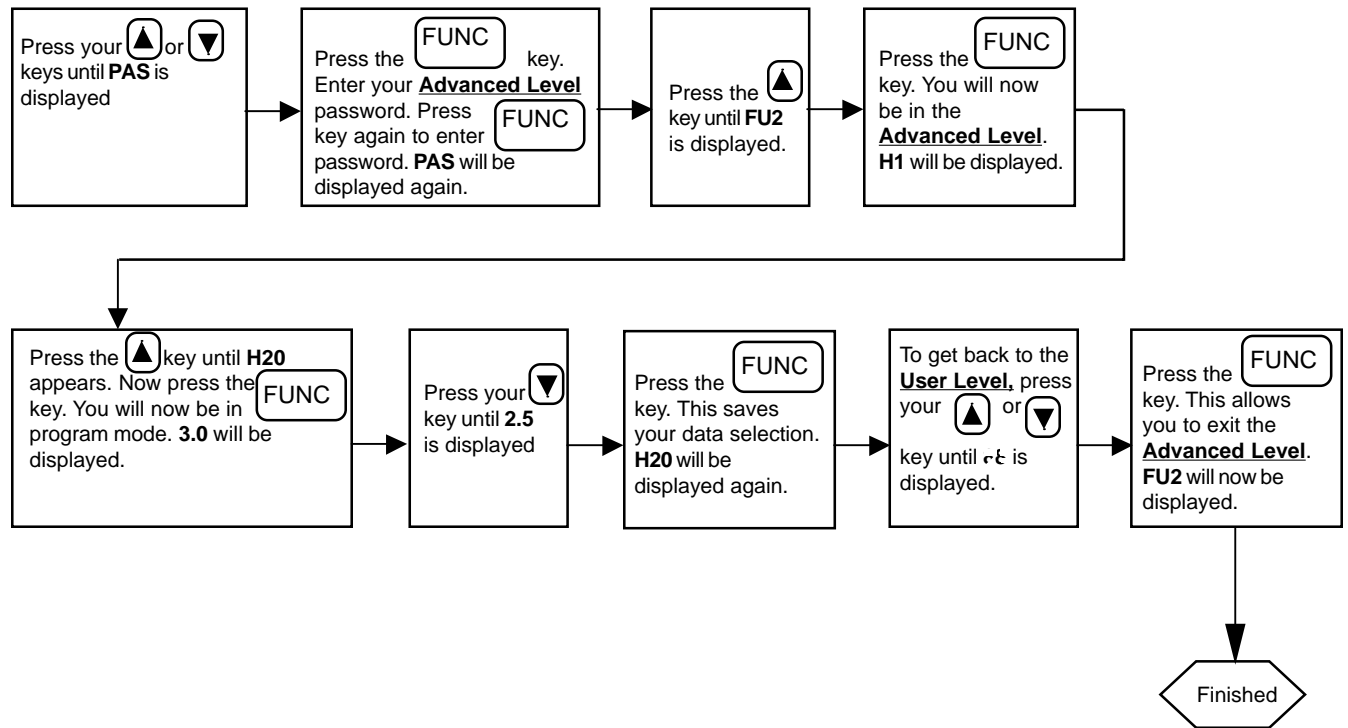

## Section 3.3: Establishing Motor Parameters

When establishing the motor parameters, assure the motor rated current does not exceed the drive current rating. The default values for the Advanced Level functions number 20, 21, and 22 may be set to values more closely representing the motor being used with the drive. This is accomplished as follows:

1. Determine the motor synchronous speed and full load speed in revolutions per minute.
2. Calculate the rated motor slip in Hertz using the following equations.

$$\text{Rated Motor Slip (rpm)} = [\text{motor sync speed (rpm)} - \text{motor rated speed (rpm)}]$$

$$\text{Rated Motor Slip (Hertz)} = \frac{60 \text{ Hz.} \times [\text{rated motor slip (rpm)}]}{\text{motor sync speed (rpm)}}$$

3. Set Advanced Level function number 20 to the rated motor slip value calculated in Hertz in step 2.
4. Obtain the motor rated current in amperes from the motor nameplate.
5. Obtain the drive current rating in amperes.
6. If the motor rated current obtained in step 4 is greater than the drive current rating obtained in step 5, use a larger drive having a current rating equal to or greater than that of the motor.
7. If the motor rated current obtained in step 4 is less than the drive current rating obtained in step 5, set Advanced Level function number 21 to the motor rated current obtained in step 4.
8. Calculate the minimum drive phase loss detection current.

$$\text{Minimum Drive Current (Amperes)} = 0.15 \times [\text{drive rated current (Amperes)}]$$

9. Calculate the motor no load current.

$$\text{Motor No Load Current (Amperes)} = 0.30 \times [\text{motor rated current (Amperes)}]$$

10. If the motor no load current calculated in step 9 is less than the minimum drive phase loss detection current calculated in step 8, the drive cannot detect phase loss and phase loss protection is no longer guaranteed. Consult the factory.

11. If the motor no load current calculated in step 9 is greater than the minimum drive current calculated in step 8, set Advanced Level function number 22 to the motor no load current value calculated in step 9.

EXAMPLE:

5 HP drive having rated current of 8 ampere used with 1 HP motor having rated current of 1.3 amp

$$\text{Minimum drive current} = 0.15 \times 8 \text{ amp} = 1.2 \text{ amp}$$

$$\text{Motor no load current} = 0.3 \times 1.3 \text{ amp} = 0.39 \text{ amp}$$

The no load motor current is less than the minimum phase loss detection current. If the no load motor current is less than 15% of the drive rated current, the drive may detect an erroneous phase loss and phase loss protection is no longer guaranteed.

# Chapter 4: Troubleshooting

## Section 4.1: Monitoring Current and Error Codes

### 4.1.1 Monitoring Current During Operation in User Level

### 4.1.2 Error Code Monitoring

#### Table 4.1.1: Error Code Description

#### Table 4.1.2: Error Code Troubleshooting

## Section 4.2: Problem Flowcharts

## Section 4.3: Testing Power Components

## Section 4.4: Pushbutton Pendant Test

## Section 4.1: Monitoring Current and Error Codes

### 4.1.1 Monitoring Current During Operation in User Level.

Go to [Function No. 4 - CUr] in the User Level. Use Table 2.2.1 for reference.

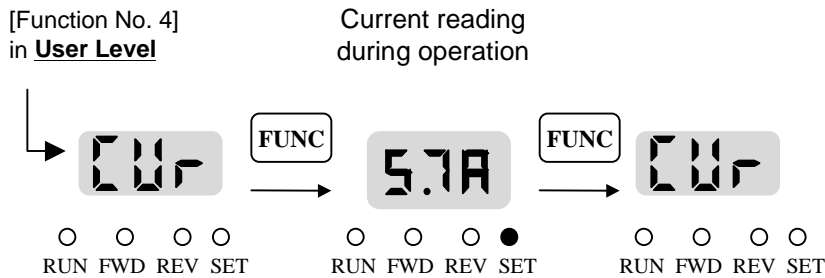

### 4.1.2 Error Code Monitoring when Fault Takes Place in User Level

In this example, the fault reading is **OC** (Over Current).

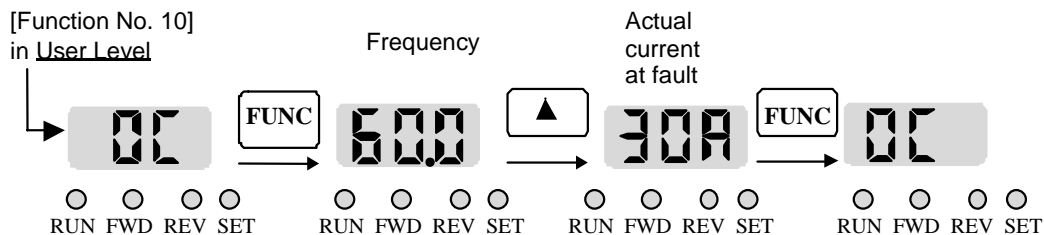

Pressing the STOP/RESET key at any point in the Fault Monitoring sequence will clear the fault and allow the drive to be run again.

- When a fault occurs the display automatically shifts to [**User Function 10**] which displays the fault code. It is possible to monitor the frequency and current at the time of the fault. To read this information, press the **FUNC** key, then the **UP** arrow key once. This shows the frequency at the time the fault occurred. Press the **UP** arrow key again, the current at the time of the fault occurred is displayed. This information is very helpful for troubleshooting the cause of the fault, and will be requested if help from the factory is sought. Press the **FUNC** key to go back to the fault display. While monitoring the fault information, the 4 LED's will flash.
- It is possible to clear the fault by pressing the STOP/RESET key.
- If there are no faults in the history, all three functions [**User Functions 10, 11 and 12**] will display **Ft1** until a fault occurs.

Table 4.1.1: Fault Code Description











Protective function	Description
<p><b>Over-current protection</b></p> 	<p>Drive automatically cuts off its output, if the output current is over 200% of the drive's rated current.</p> <p>Caution: Since there is a possibility of damage in the power module (IGBT), <b>DO NOT</b> restart the drive until properly checked. See <a href="#">Testing Power Components</a> in Chapter 4 for checking power modules.</p>
<p><b>Over-voltage protection</b></p> 	<p>Drive automatically cuts off its output if the regenerative energy from the motor deceleration or generative load makes the DC voltage (DC Link voltage) of the drive over 400V for 230V applications, or over 800V for 460V applications.</p>
<p><b>Current limit protection</b></p> 	<p>Drive automatically cuts off its output if the current has over 180% of the drives rated current during the current limit time setting. This fault is affected by the value set in parameter H30 of the <b>Advanced Level</b>.</p>
<p><b>Heat-Sink overheat</b></p> 	<p>When the drive heat-sink overheats, the temperature detection element triggers the drive to automatically cut off its output. A failed cooling fan or a foreign substance in the cooling fan can cause this.</p>
<p><b>EtH</b></p> 	<p>Automatically shuts off the output of the drive if the condition meets the function settings made in H31 and H32 of the <b>Advanced Level</b>. Under the default settings, an ETH fault would occur if there is any over-current 100% greater than the rated current and/or an overload capacity of 150% / 1 min.</p>
<p><b>Phase fault</b></p> 	<p>Occurs when one (1) or more output leads to the motor are opened. Parameters H22 and H49 of the <b>Advanced Level</b> affect how the drive responds to a phase loss.</p>
<p><b>Low Voltage protection</b></p> 	<p>A voltage drop to the drive can cause a lack of torque and/or motor overheating. This fault automatically shuts off the output of the drive when the DC voltage (DC Link Voltage) of the control circuit is below 200V for 230VAC applications or 400 volts for 460VAC applications.</p>
<p><b>BX protection</b></p> 	<p>This fault occurs if the BX terminal is being used. A BX fault shuts off the output of the drive when the BX terminal is ON in the driving mode and restarts when it is OFF.</p>
<p><b>CPU error</b></p> 	<p>Drive shuts off its output when there is an error in main CPU caused by system noise. It is possible to clear the error by pressing STOP/RESET key.</p>
<p><b>Communication Error</b></p> 	<p>Displays the error in the communication between the main unit and the <u>keypad</u>, which has no influence on drive operation. It may be cleared by removing the <u>keypad</u>.</p>

Table 4.1.2: Error Code Troubleshooting

Protective Functions	Causes	Solutions
<b>Over-Current Protection</b>	<ol style="list-style-type: none"> <li>1. Faster acceleration and deceleration time than load inertia requirements.</li> <li>2. Larger load than the rated capacity of the drive.</li> <li>3. Driving while motor coasting.</li> <li>4. Traverse worm gear speed reducer using default stop mode, <b>F20</b> (1: Ramp to Stop)</li> </ol>	<ol style="list-style-type: none"> <li>1. Extend acceleration and deceleration time (User Function 7 &amp; 8).</li> <li>2. Upgrade the drive capacity.</li> <li>3. Start driving after motor stops.</li> <li>4. Set <b>F20</b>, Stop Mode to (2: Immediate Stop).</li> </ol>
<b>Over-Voltage Protection</b>	<ol style="list-style-type: none"> <li>1. Too short of deceleration time compared to load inertia.</li> <li>2. Excessive regenerative energy on the load side of drive.</li> <li>3. Excessively high input voltage.</li> <li>4. Noisy electrical environment.</li> </ol>	<ol style="list-style-type: none"> <li>1. Extend deceleration time (User Function 8).</li> <li>2. Check Dynamic Braking Resistance.</li> <li>3. Check the input power supply.</li> <li>4. Correct input power or add 3% impedance line reactor.</li> </ol>
<b>Current Limit Protection (OLt)</b>	<ol style="list-style-type: none"> <li>1. Larger load than the drive's rated capacity.</li> <li>2. Incorrect setting of the drive capacity.</li> <li>3. Incorrect setting of V/F pattern.</li> <li>4. Bumping fixed objects.</li> </ol>	<ol style="list-style-type: none"> <li>1. Upgrade the motor and the drive capacity in accordance with the load.</li> <li>2. Reset the drive capacity (F8).</li> <li>3. Adjust V/F pattern (F14 and/or H2 – H5).</li> <li>4. Verify OLt time duration is adequate for application.</li> </ol>
<b>Heat-Sink Overheat</b>	<ol style="list-style-type: none"> <li>1. Failed cooling fan or foreign object in the fan.</li> <li>2. An abnormal condition in the cooling system.</li> <li>3. High ambient temperature.</li> </ol>	<ol style="list-style-type: none"> <li>1. Remove the foreign object, or replace the cooling fan.</li> <li>2. Check the heat-sink fins.</li> <li>3. <ol style="list-style-type: none"> <li>a. Lower the ambient temperature below 104° F (40° C)</li> <li>b. Ventilate or air condition control enclosure</li> </ol> </li> </ol>
<b>Electronic Thermal Detection (EtH)</b>	<ol style="list-style-type: none"> <li>1. Larger load than the rated current of the drive.</li> <li>2. Low ETH level.</li> <li>3. Error in setting the drive capacity.</li> <li>4. Error in setting the V/F pattern.</li> </ol>	<ol style="list-style-type: none"> <li>1. Replace drive, or upgrade the capacity.</li> <li>2. Adjust EtH level (H32). See Section 5.3.10.</li> <li>3. Reset the drive capacity (F8).</li> <li>4. Adjust V/F pattern (F14 and/or H2 – H5).</li> </ol>
<b>Phase Fault</b>	<ol style="list-style-type: none"> <li>1. One of the output wires from (U, V, W) to motor is open.</li> <li>2. Setpoint of Motor No Load Current is too high.</li> </ol>	<ol style="list-style-type: none"> <li>1. Make sure the motor leads are connected tightly at drive terminals (U, V, W) and at motor.</li> <li>2. Verify motor data and adjust H20, H21 and H22 as necessary. See Section 3.3.</li> </ol>
<b>Low Voltage Protection</b>	<ol style="list-style-type: none"> <li>1. Low voltage input supply.</li> <li>2. Larger load than the rated power capacity of the drive.</li> <li>3. Faulty magnetic mainline contactor in power circuit.</li> </ol>	<ol style="list-style-type: none"> <li>1. Check the input power voltage.</li> <li>2. Upgrade power capacity.</li> <li>3. Replace magnetic mainline contactor.</li> </ol>



## Section 4.2: Problem Flowcharts

Fig. 4.2.1: Motor Does not Run

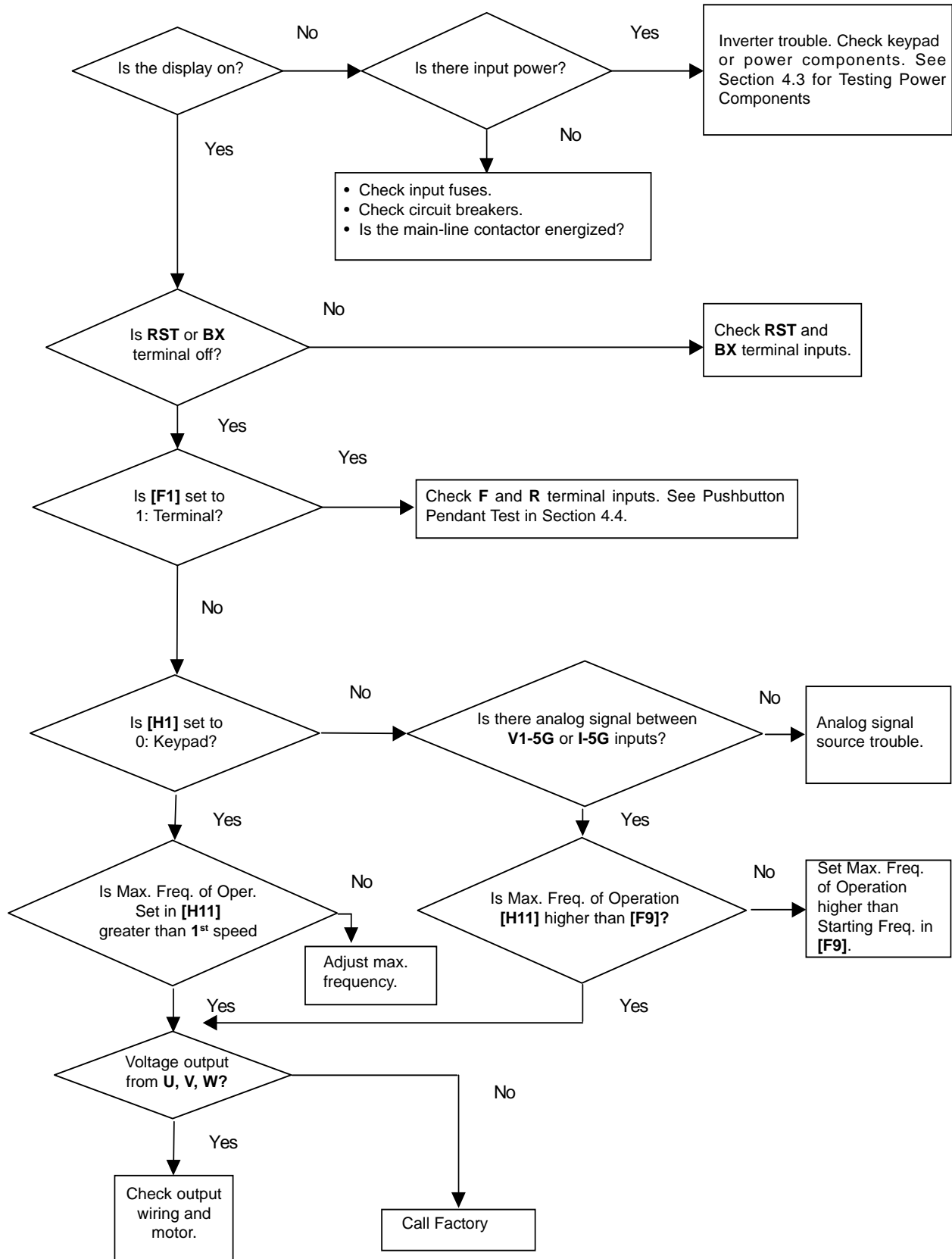

Fig. 4.2.2: Motor Speed is not equal to the Maximum Operational Frequency

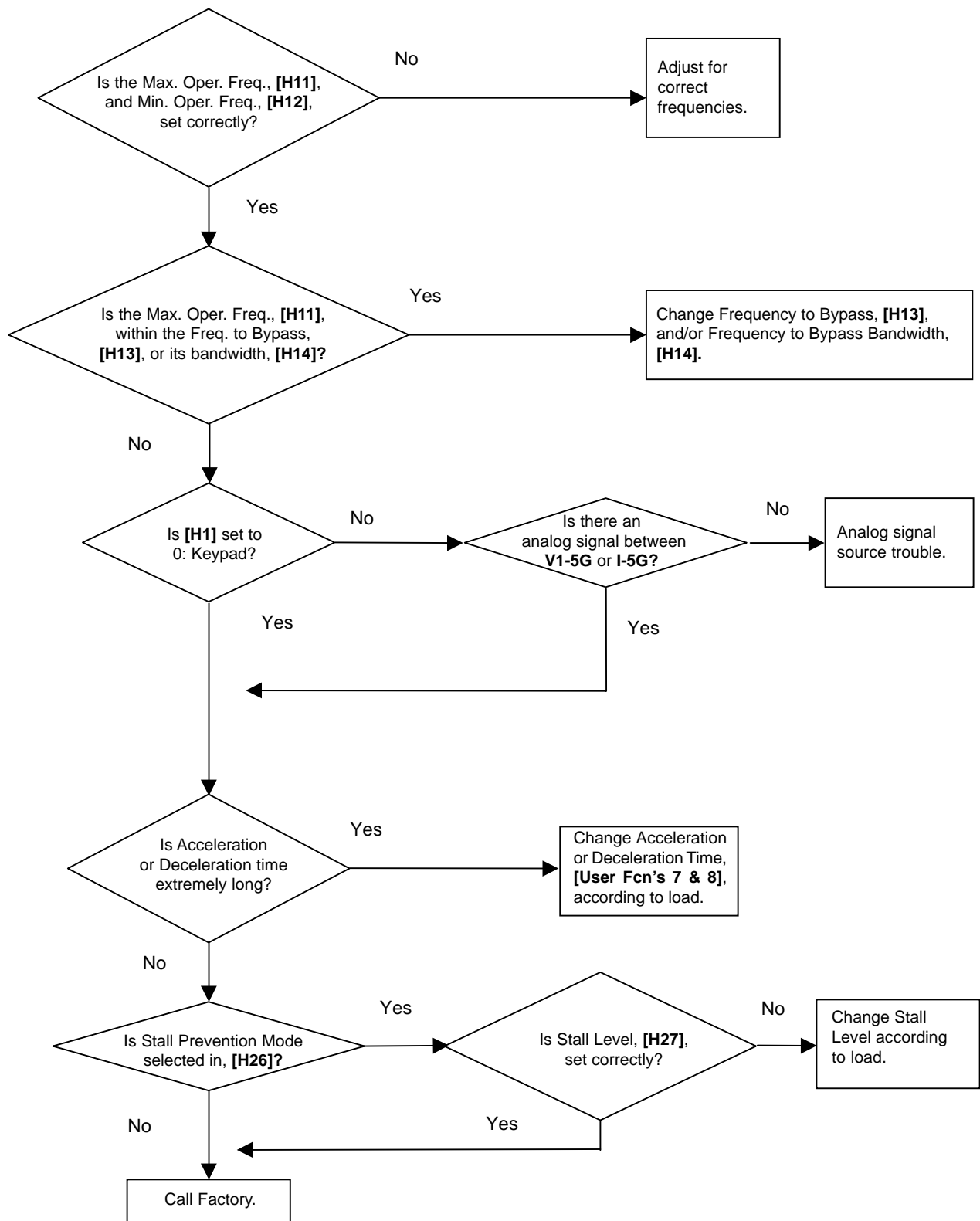

Fig. 4.2.3: Motor does not run smoothly

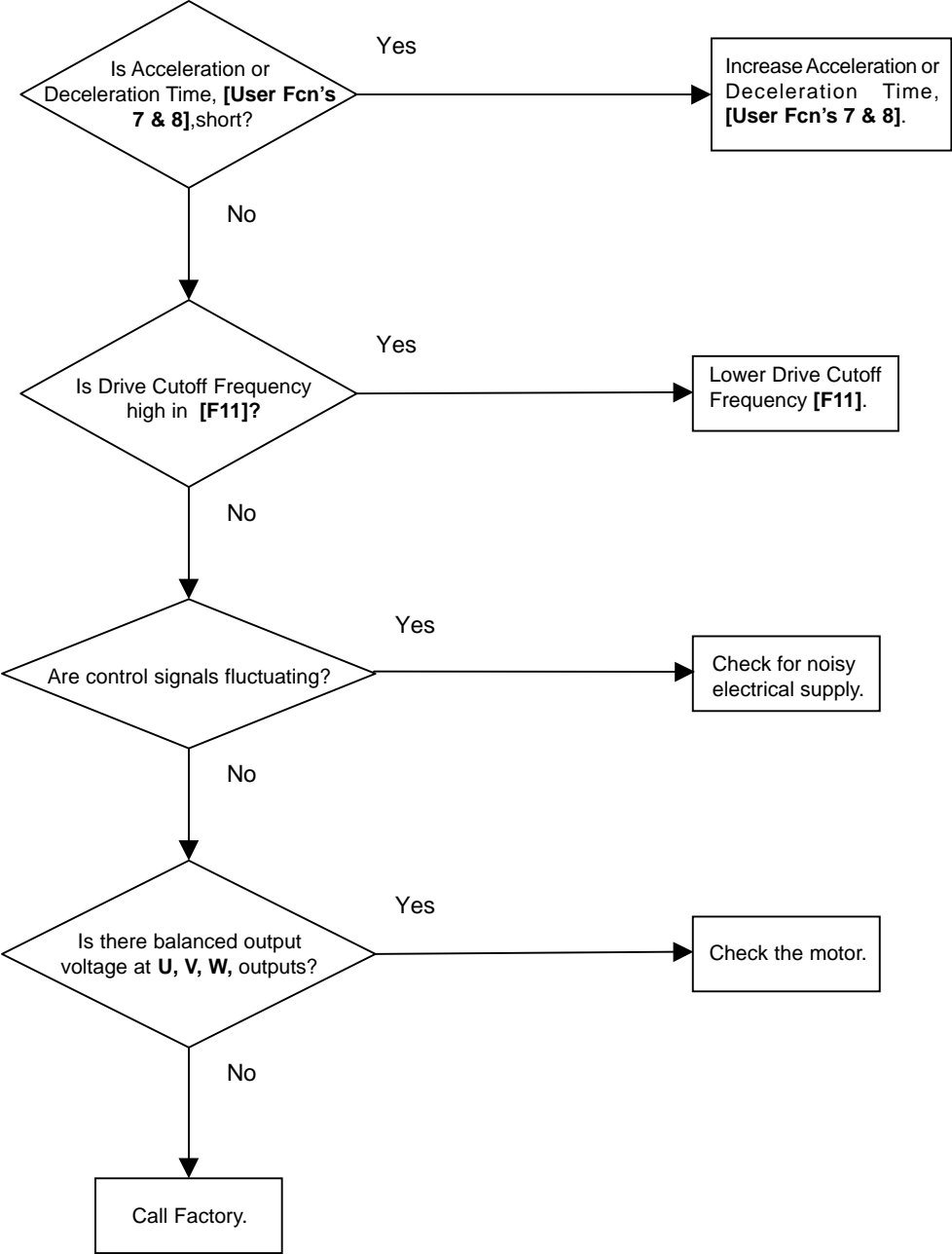
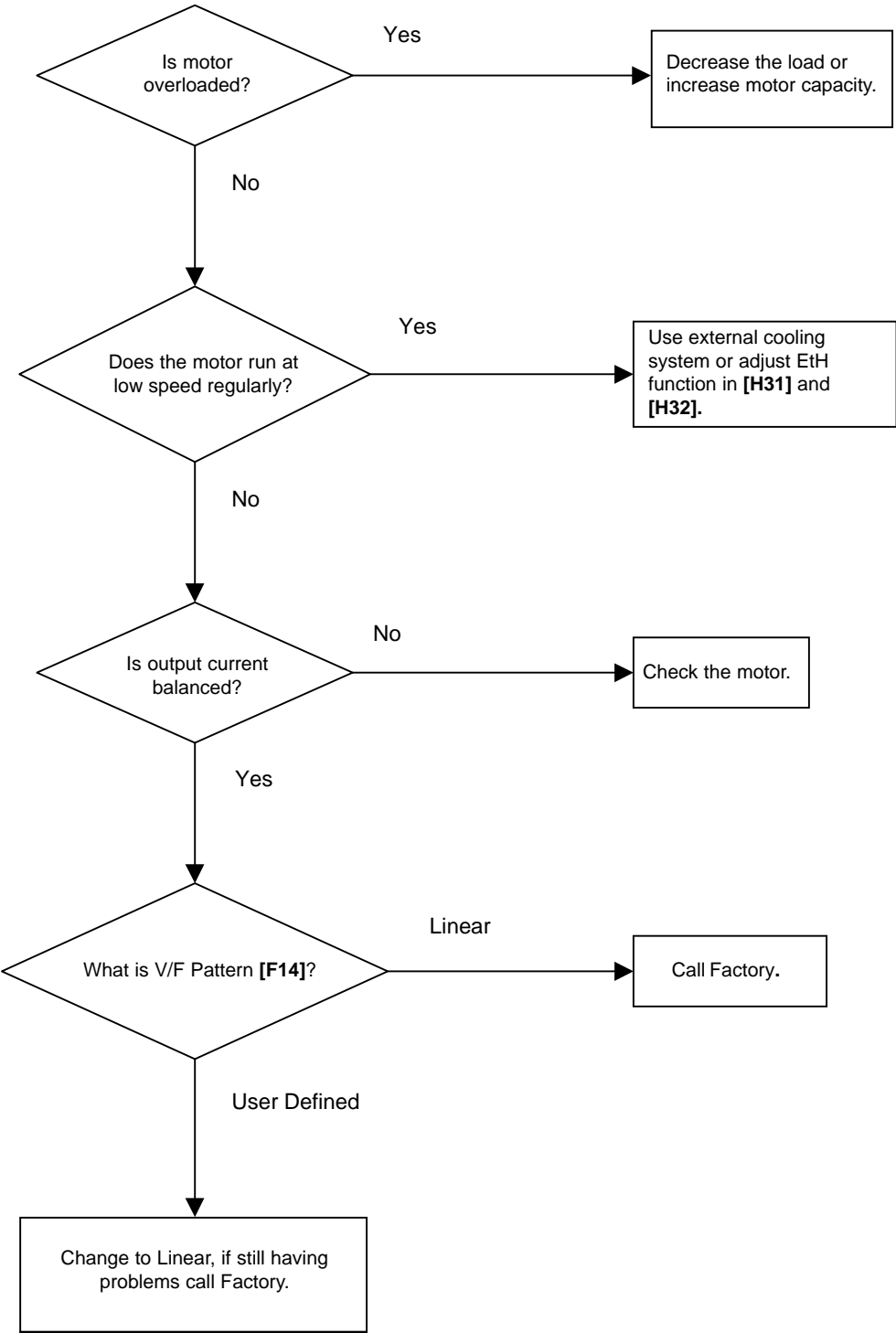

Fig. 4.2.4: Motor is abnormally hot



## Section 4.3: Testing Power Components

### 4.3.1 How to Check Power Components

Before checking the power components, be sure to disconnect the AC input supply and wait until the main electrolytic capacitor (P1-N) discharges. This may take several minutes.

Fig. 4.3.1: SV100 Power Components Functional Diagram

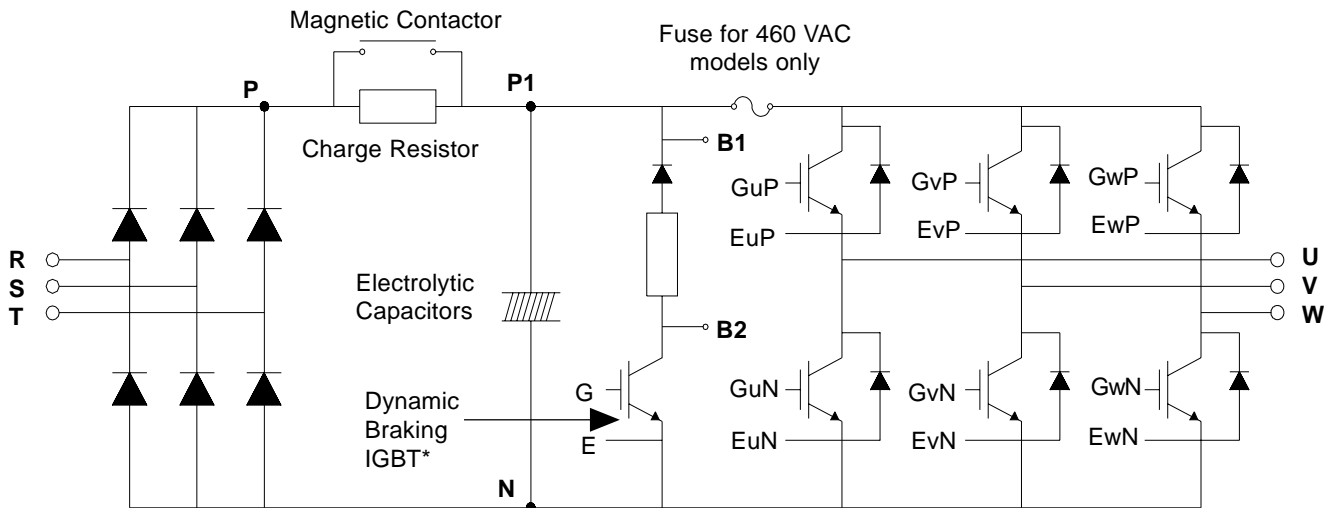

Table 4.3.1: Power Component Test Values - All resistance values measured with multi-meter leads From + to -.

#### Input Diode Module Check

Check Points	Resistance to be Good
From R, S, or T to P	50k ohms or more
From R, S, or T to N	50k ohms or more

#### Charge Resistor Check

Check Points	Resistance to be Good
From P to P1	Resistance depending on Models. Models 446485-07/08 50 $\Omega$ All other models 100 $\Omega$

#### DB (Dynamic Braking) IGBT\*

Check Points	Resistance to be Good
From B2 to N	50k ohms or more
From G to N	A few kilo ohms

#### Output Diode Module Check

Check Points	Resistance to be Good
From U, V, or W to P1 and U, V, or W to N	50k ohms or more
Between Gate and Emitter of each IGBT	A few kilo ohms

\*IGBT = Isolated Gate Bipolar Transistor

## Section 4.4: Pushbutton Pendant Test

### 4.4.1 Interface Card Input and Output Test

The condition of the interface card can be monitored by using the 7-segment keypad display. You must first go to **Status of Input Terminal** located in the **User Level** [Function No.13 – InP]. Press the **FUNC** key and monitor the 7-segment display as you press the respective pushbuttons. B4 is an dry contact output used for brake control and indicates when the drive has activated the brake release. **Example:** If F and 3 terminals are energized, Figure 4.4.1 shows the lights are ON for those respective terminals. R, B4, P and 2 indicator lights are lit in the OFF row signifying that they are not energized.

Fig. 4.4.1: LED display for interface card test.

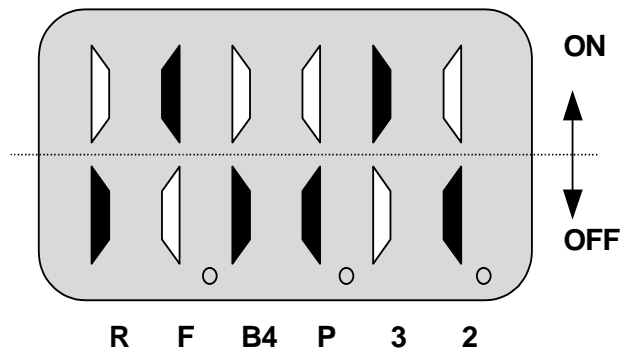

- Each column represents an input terminal of your interface card.

### 4.4.2 Control Board Input and Output Test

The condition of the input terminals and brake control output can be monitored by using the 7-segment keypad display. Remove the interface card. Go to **Status of Input Terminal** located in the **User Level** [Function No.13 – InP]. Press the **FUNC** key and monitor the 7-segment display as you close the connection between the respective inputs and CM on the main control board. The inputs are sinking type DC inputs, so using a jumper wire between the input and CM should cause the input to be on. MO is an open collector output used for brake control and indicates when the drive has activated the brake release. **Example:** If FX and P3 terminals are jumpered, Figure 4.4.2 shows the lights are ON for those respective terminals. RX, MO, P3 and P1 indicator lights are lit in the OFF row signifying that they are not energized.

Fig. 4.4.2: LED display for Control Board Input test.

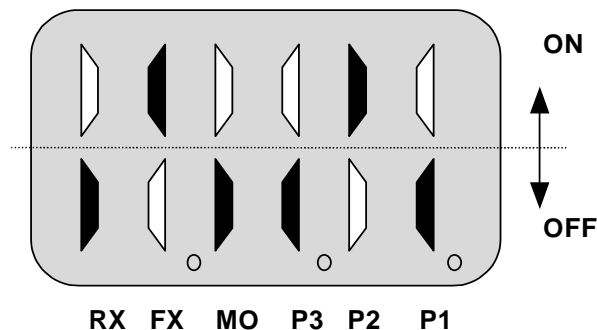

# **Chapter 5: Function Code Information**

## **5.1: User Function Levels**

**5.1.1 Frequency Output Monitor**

**5.1.2 Frequency Reference**

**5.1.3 Accel / Decel**

**5.1.4 Drive Operation Monitoring**

## **5.2: Service Level Functions**

**5.2.1 Command Reference (RUN /STOP Selection)**

**5.2.2 Accel / Decel Patterns**

**5.2.3 Multi-Function Inputs**

**5.2.4 Multi-Function Output**

**5.2.5 Drive Model Selection**

**5.2.6 Frequency Settings**

**5.2.7 Brake Release Timing (Dwell Function)**

**5.2.8 V / F Pattern**

**5.2.9 Torque Boost**

**5.2.10 Output Voltage Adjustment**

**5.2.11 Frequency Detection**

**5.2.12 Braking**

**5.2.13 Upload / Download from Keypad and Set Defaults**

## **5.3: Advanced Level Functions**

**5.3.1 Frequency Reference Source**

**5.3.2 User V / F Frequency**

**5.3.3 Analog Frequency Control**

**5.3.4 Operational Maximum / Minimum Frequency**

**5.3.5 Frequency to Bypass**

**5.3.6 DC Braking**

**5.3.7 Motor Data**

**5.3.8 Auto Restart**

**5.3.9 Stall Prevention**

**5.3.10 Drive and Motor Protections**

**5.3.11 Instantaneous Power Failure and Speed Search**

**5.3.12 Restart After Reset**

**5.3.13 Carrier Frequency**

**5.3.14 Multi-Meter Output for Current, Voltage and Frequency**

**5.3.15 Motor Phase Loss**

**5.3.16 Reverse Plugging**



## Section 5.1: User Level Functions

### 5.1.1 Frequency Output Monitor

The drive frequency can be monitored via Keypad and Multifunction output terminals.

VIA KEYPAD

**User Level** [Function No. 1]: Displays Drive Frequency Output

The Keypad displays the drive frequency output to the motor once the RUN command is initiated.

When the drive is not in RUN mode, the frequency display indicates the programmed speed 1 frequency.

VIA FREQUENCY METER TERMINAL (See Section 5.3.14)

### 5.1.2 Frequency Reference

**User Level** [Function No. 1] Speed 1 (Factory Default: 10.0 Hz.)

Range: 0.0 – F9 Hz.

**SP2** (User Level): Speed 2 (Factory Default: 60.0 Hz.)

Range: 0.0 – F9 Hz.

**SP3** (User Level): Speed 3 (Factory Default: 0.0 Hz.)

Range: 0.0 – F9 Hz.

**SdS** (User Level): Speed Mode Macro (Factory Default: 1: 2 Step Infinitely Variable)

Range: 0: 2 Speed

1: 2 Step Infinitely Variable

2: 3 Speed

3: 3 Step Infinitely Variable

The hoist speed references are set in the **User Level**. **Speed 1 and 2** will be applied when **SdS** is set to 0 or 1. **Speed 1, 2, and 3** will be applied when **SdS** is set to 2 or 3. The value of these speed points will be limited depending on the value **Maximum Frequency** set in **F9**. Generally, the maximum frequency is set to the maximum motor allowed output speed. The **Rated Frequency of Motor** (Base Frequency) **F10** is the motor rated speed in constant torque range. This base frequency value should not be set higher than that of **F9**.

For frequency settings of **F9**, **F10** and **F11** see Section 5.2.6.

### 5.1.3 Accel / Decel

**User** [Function No. 7] - Acceleration Time (Factory Default: 3.0 sec.)

Range: 0.0 – 999 sec.

**User** [Function No. 8] - Deceleration Time (Factory Default: 3.0 sec.)

Range: 0.0 – 999 sec.

Operator can program acceleration and deceleration times via keypad of the SV100 drive through the above parameters.

Fig. 5.1.1: Acceleration/Deceleration Time

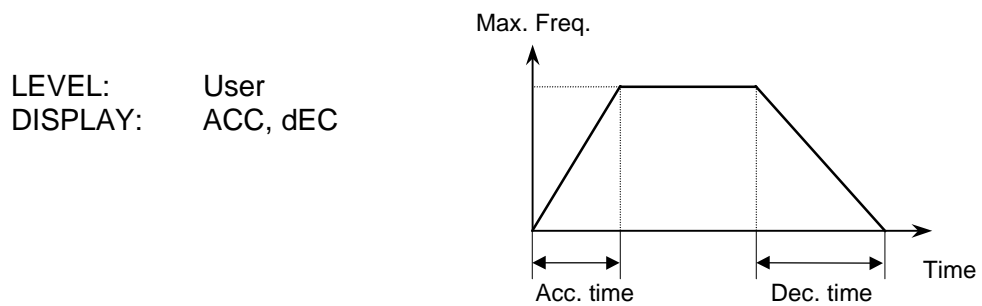

### 5.1.4 Drive Status Monitoring

The drive operational status can be monitored via the drive keypad and Multi-Meter output terminal.

#### FAULT HISTORY

**User** [Function Nos. 10, 11, 12]

Ft1 is the current fault if the drive is faulted and is not used when the drive is not faulted. Drive keeps detailed fault information in two fault history parameters, plus a memory location for the current fault, if there is one. Each fault history parameter contains a fault code with drive status, drive output current and the frequency output at the time of the fault. These conditions can be viewed by the using up and down arrow keys of the keypad. See Section 4.1.2 for detailed instructions on all fault code locations.

#### RESETTING A FAULT

The SV100 drive fault can be reset either from the keypad STOP/RESET button or from the external fault reset terminal RST, or by turning power off, and back on after approximately 3 min.

For the keypad reset, please refer to Section 4.1.2.

#### STATUS OF INPUT AND OUTPUT TERMINAL

Drive input terminal status and brake control output status can be monitored in User Function No. 13 [**InP**]. This feature is a useful feature for drive trouble-shooting. The status of selected terminals are displayed on the LED display. See Section 4.4 for a description of this feature.

#### SOFTWARE VERSION

**vEr:** Software Version

Example: H2C: Lift-Tech Software Version #2,  
This is the software version of the SV100 drive

#### PASSWORDS

See Section 3.1 for an explanation of this feature.

## Section 5.2: Service Level Functions

### 5.2.1 Command Reference (RUN/STOP Selection)

The drive can receive its command sequence (RUN, STOP, FWD, REV), via external terminals.

**F1:** Run/Stop Mode (Factory Default: 1: Terminal)  
 Range: 0: Keypad  
 1: Terminal

#### KEYPAD

The JOG function works via the keypad only. See Section 2.2.3 for instructions on use.

#### TERMINAL

Each of the sequence commands can be initiated via external controls, such as pushbuttons.

Table 5.2.1: Drive Input Terminals

Drive Control Board Input Terminals		Interface Card	
Fx	Up / Forward Direction Command Terminal. 24 VDC Sinking.	F	Up / Forward Direction Command Terminal. 120 VAC Sourcing.
Rx	Down / Reverse Direction Command Terminal. 24 VDC Sinking.	R	Down / Reverse Direction Command Terminal. 120 VAC Sourcing.
RST	Fault Reset Reset. 24 VDC Sinking.		
P1	Multi-Function Input 24 VDC Sinking.	2	Multi-Function Input 120 VAC Sourcing.
P2	Multi-Function Input 24 VDC Sinking.	3	Multi-Function Input 120 VAC Sourcing.
P3	Multi-Function Input 24 VDC Sinking.	P	Multi-Function Input 120 VAC Sourcing.
CM	Common Terminal for 24 VDC Sinking Inputs.	C	Common Terminal for 120 VAC Sourcing Inputs

### 5.2.2 Accel / Decel Patterns

**F2:** Acceleration Pattern (Factory Default: 1: S Curve)  
 Range: 0: Linear  
 1: S Curve

**F3:** Deceleration Pattern (Factory Default: 0: Linear)  
 Range: 0: Linear  
 1: S Curve

These values are set with Motion Definition Macro, see Table 2.3.1. The user can select different acceleration and deceleration patterns for smoother hoist or traverse ramping.

## LINEAR

The linear pattern is generally good for hoists without a mechanical load brake with sufficient output torque.

Fig. 5.2.1: Linear Acceleration/Deceleration Curve

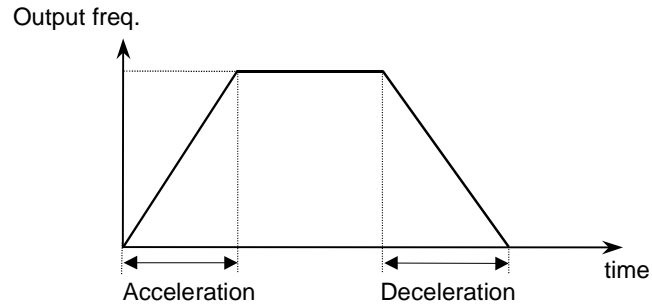

## S-CURVE

This pattern is used to initiate smooth ramping during an Acceleration or Deceleration sequence. This pattern is suitable for hoists with a mechanical load brake, creating less brake wear.

Fig. 5.2.2: S-Curve Acceleration/Deceleration Curve

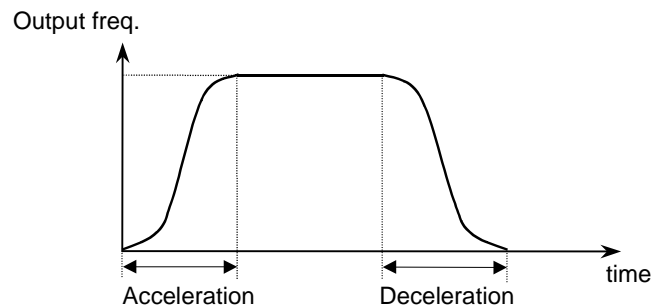

## 5.2.3 Multi-Function Inputs

The SV100 drive is equipped with 3 Multi-Function Inputs, which determine how the drive reacts to inputs from the controls. They can be configured to be Speed 2, Speed 3, Frequency Increasing, Frequency Hold, Immediate Stop, Ramp to Stop, or Low Speed.

**F4, F5, F6:** Multi-function Input

(Factory Default: See Section 2.3.2)

Range: 0: Speed 2

1: Speed 3

2: Reserved

3: Frequency Increasing

4: Frequency Hold

5: Immediate Stop

6: Ramp to Stop

7: Low Speed Limit Switch

**Speed 2:** With an input of either run command (F or R) the drive will run at the programmed speed of SP2 [User Function 5].

**Speed 3:** With an input of either run command (F or R) and input SP2 the drive will run at the programmed speed of SP3 [User Function 6].

**Reserved:** Reserved for future use.

**Frequency Increasing:** For use with either 2 Step Infinitely Variable or 3 Step Infinitely Variable, causes drive output to increase when there is a run command (F or R). If 3 Step Infinitely Variable then Frequency Hold is required also.

**Frequency Hold:** Used as the second detent on a pushbutton for 3 Step Infinitely Variable control. Causes the drive frequency output to hold at last value.

**Immediate Stop:** When a Multi-Function Input is programmed for this operation and the Normally Closed input opens, the drive output immediately stops. (Default for hoist control).

**Ramp to Stop:** When a Multi-Function Input is programmed for this operation and the Normally Closed input opens, the drive output ramps to a stop. (Default for traverse control). NOT RECOMMENDED FOR HOIST MOTION.

**Low Speed Limit Switch:** When a Multi-Function Input is programmed for this operation and the Normally Closed input opens, the drive output ramps to the value in User Function 9 (LSP).

## 5.2.4 Multi-Function Output

The SV100 drive is equipped with a Normally Open contact between B3 and B4 on the interface card. It can be configured to be frequency detection, motor stall, overload, low voltage indicator, and Run /Stop indication.

<b>F7:</b> Multi-function Output	(Factory Default: 1:Freq. Reach N.O.)
Range: 0: Frequency Reaching Time (Normally Closed)	(See Section 5.2.11)
1: Frequency Reaching Time (Normally Open)	(See Section 5.2.11)
2: Stall Operation Signal	(See Section 5.3.9)
3: Overload Signal	(See Section 5.3.10)
4: Low Voltage (LV fault) Signal	
5: Run/Stop Signal	

### STALL OPERATION SIGNAL

Multi-Function Output terminals B3 and B4 programmed to 2: Stall Operation Signal will close when the drive's Stall Prevention control is activated. As there is only one Multi-Function Output available, there will be no brake control, therefore it is advised this output function NOT be used in hoist applications, this has no effect on the drive Stall Response.

## LOW VOLTAGE SIGNAL

Multi-Function Output terminals B3 and B4 programmed to 4: Low Voltage (LV fault) Signal will close when the DC Link voltage falls below the low voltage level of the drive (200VDC for 230 VAC, and 400VDC for 460 VAC drives).

Fig. 5.2.3: Under-voltage Fault Signal

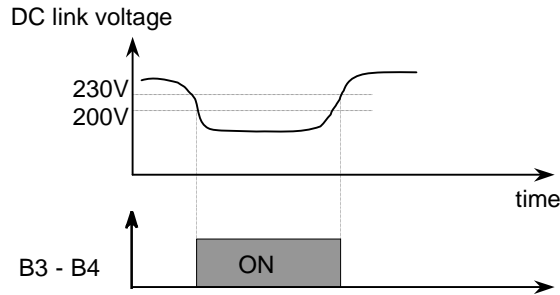

## RUN / STOP SIGNAL

The Multi-Function Output terminals B3 and B4 programmed to 5: Run/Stop Signal will close when the drive changes from a stop condition to a run condition.

### 5.2.5 Drive Model Selection

**F8:** Drive Model Selection (Factory Default: See Table 5.2.2)  
Range: See Table 5.2.2 below.

The drive model selection for each drive is preset at the factory. This parameter must be set correctly in order for the drive to calculate its output current. Table 5.2.2 cross references the drive model number, horsepower, and voltage rating, and lists the default values for Rated Motor Current (**H21**) and No Load Motor Current (**H22**).

Table 5.2.2: SV100 Part Number Cross Reference to Drive Model Selection

Model No.	Description	Part No.	FLA (H21)	NLA (H22)
1.2	1 HP - 230 Volt	446485-01	4.2	0.6
2.2	2 HP - 230 Volt	446485-02	6.8	1.8
3.2	3 HP - 230 Volt	446485-03	9.6	2.8
5.2	5 HP - 230 Volt	446485-04	15.2	4.4
1.4	1 HP - 460 Volt	446485-05	2.1	0.3
2.4	2 HP - 460 Volt	446485-06	3.4	0.9
3.4	3 HP - 460 Volt	446485-07	4.8	1.4
5.4	5 HP - 460 Volt	446485-08	7.6	2.2

## 5.2.6 Frequency Settings

**F9:** Maximum Frequency of Operation (Factory Default: 60.0 Hz.)  
Range: 40.0 - 120 Hz.

**F10:** Rated Frequency of Motor (base frequency)  
Range: 40.0 – F9 Hz. (Factory Default: 60.0 Hz.)

**F11:** Drive Cutoff Frequency (Factory Default: 0.50 Hz.)  
Range: 0.01 - 5.00 Hz.

If the base frequency is set at 40 Hz and the maximum frequency is set at 60 Hz., the motor will run up to 40Hz in Constant Torque mode and up to 60 Hz. in Constant Horsepower mode. The Drive Cutoff Frequency set in **F11** provides the initial frequency output of the drive. Setting this value too high can result in increased starting torque demand from hoist load resulting in an overcurrent (OC) fault.

Fig. 5.2.4: Motor Frequency Relationship Diagram

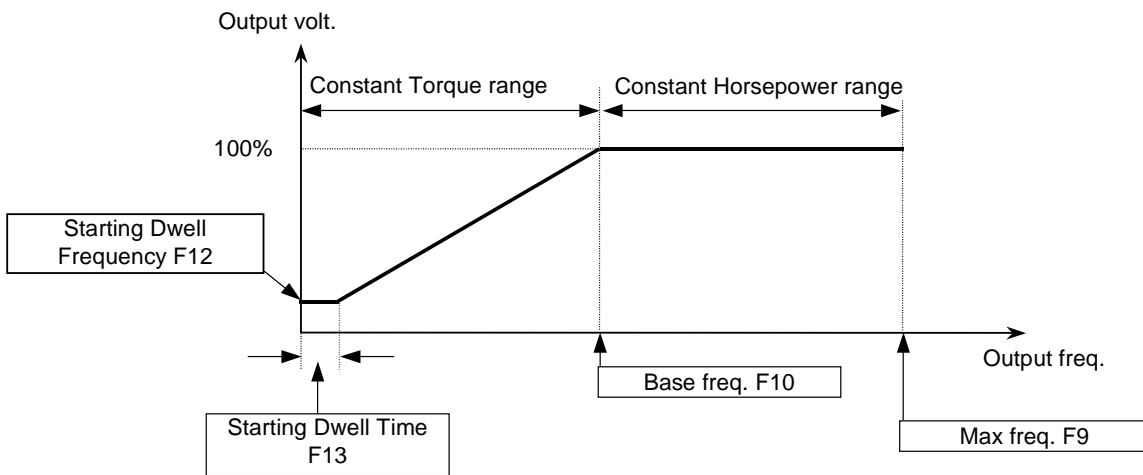



## 5.2.7 Brake Release Timing (Dwell Function)

**F12:** Starting Dwell Frequency (Factory Default: 3.0 Hz.)

Range: 0.0 – F9 Hz.

**F13:** Starting Dwell Time (Factory Default: 0.5 sec. Hoist.)

Range: 0.1 sec. – 10.0 sec. (0.1 sec. Traverse)

The dwell function is used for torque proving before the brake is released. The current is applied to the motor during the Starting Dwell Time [F13] before releasing the brake.

**Caution:** Dwell frequency should be set to the slip frequency of the motor if the slip is greater than 3 Hz. To calculate slip frequency, see Section 3.3.

Fig. 5.2.5: Brake Release Timing (Hoist)

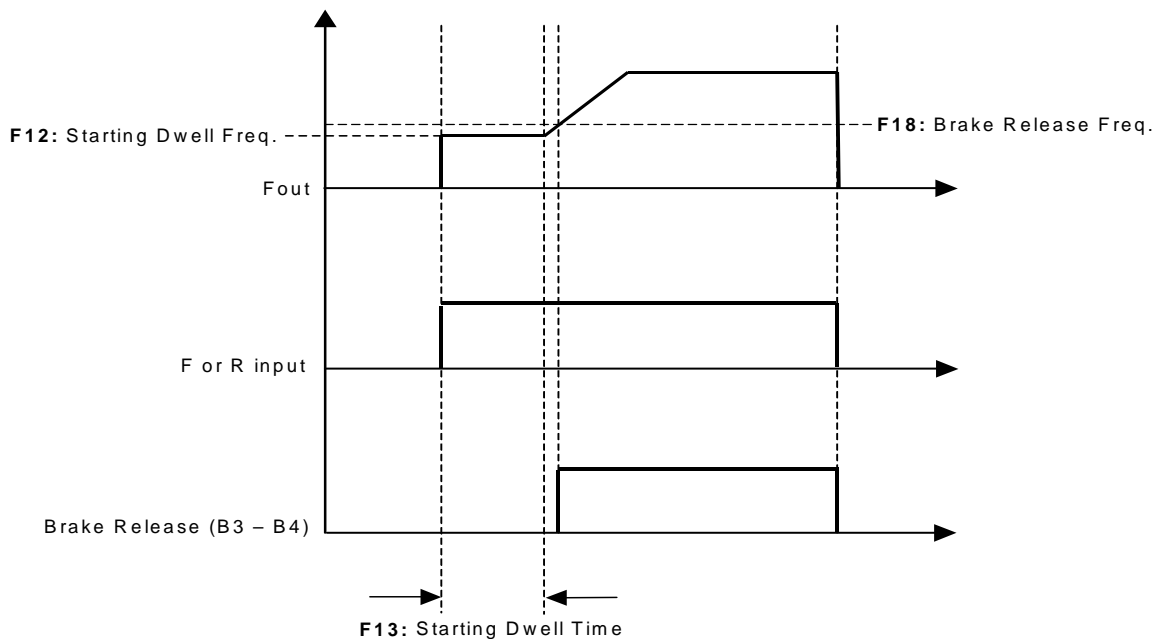
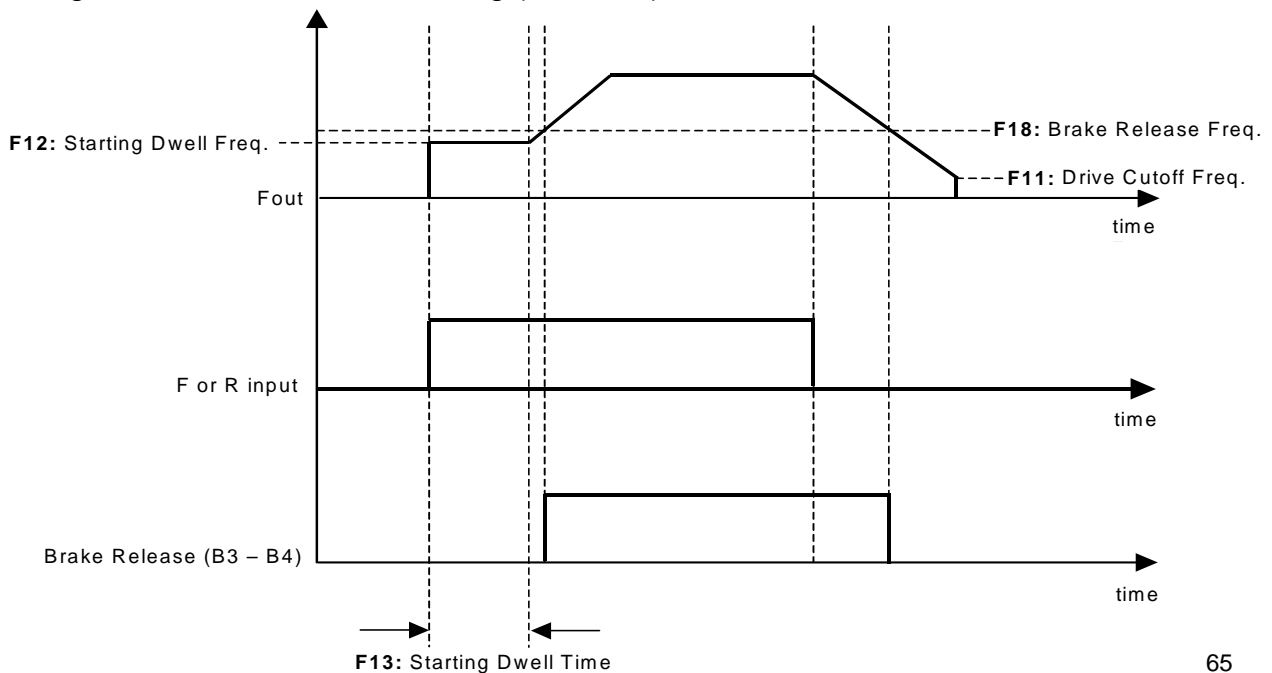

Fig. 5.2.6: Brake Release Timing (Traverse)



## 5.2.8 V/F Pattern

**F14:** Volts per Hertz Pattern (Factory Default: 0: Linear)  
Range: 0: Linear  
1: Reserved (**DO NOT USE**)  
2: User Defined V/F

Depending on the applications, different Volt/Hertz patterns can be selected. In User Defined V/F, various points of V/F ratios are programmed for the best output result. Please contact the factory for more information.

### LINEAR [Constant Torque Applications]

This pattern is best suited for Constant Torque applications like Hoist/Crane. This Linear pattern has a V/F ratio that is constant throughout the entire frequency range up to the drive base frequency.

Fig. 5.2.7: Linear V/F Diagram

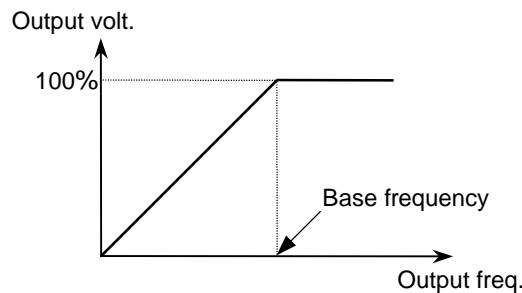

### USER V/F

The User Pattern can be used for special purpose applications. There are two V/F points that can be programmed between the starting frequency and the base frequency. See Fig. 5.2.8.

**H2:** User V/F Frequency 1 (Factory Default: 5.0 Hz.)

Range 0.0 - F9 Hz.

**H3:** User V/F Voltage 1 (Factory Default: 16 %)

Range 0 - 100 %

**H4:** User V/F Frequency 2 (Factory Default: 30.0 Hz.)

Range 0.0 - F9 Hz.

**H5:** User V/F Voltage 2 (Factory Default: 50 %)

Range 0 - 100 %

Fig. 5.2.8: User V/F Pattern

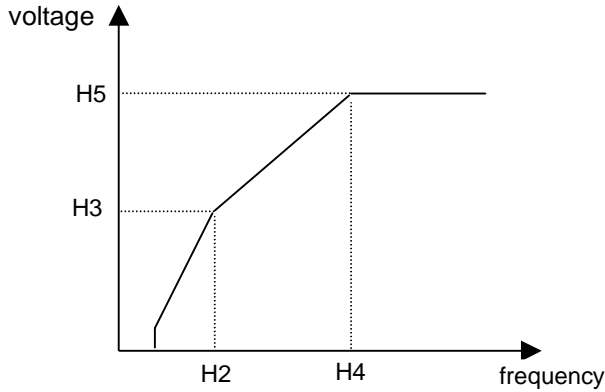

### 5.2.9 Torque Boost

- F15:** Forward Torque Boost (Factory Default: 5%)  
Range: 0 - 20 %
- F16:** Reverse Torque Boost (Factory Default: 2%)  
Range: 0 - 20 %

The forward and reverse torque boost value can be set separately. This function is used to increase the output voltage to the motor at low speeds for a higher volts/hertz ratio, resulting in a much higher starting current output to the motor. This is for loads that require relatively higher torque than normal starting torque.

**Note:** If the torque boost is set too high an Overcurrent fault may occur. When this occurs reduce the Torque Boost values.

Fig. 5.2.9: Torque Boost in Linear Pattern

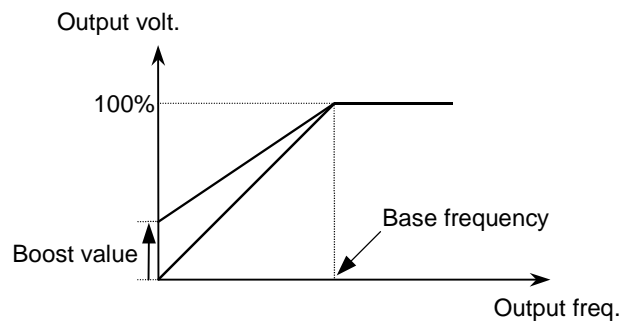
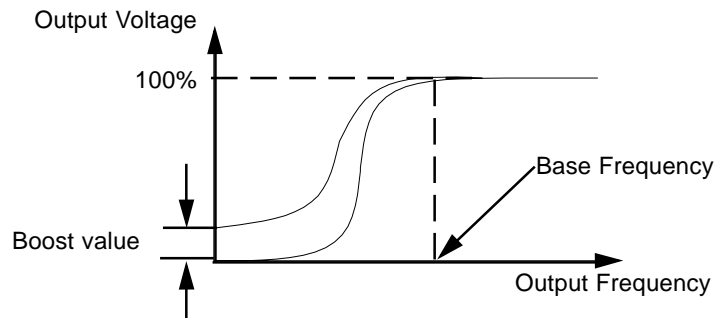

Fig. 5.2.10: Torque Boost in S-Curve Pattern



## 5.2.10 Output Voltage Adjustment

**F17:** Output Voltage Adjustment (Factory Default: 100%)  
Range: 50-110%

Inverter output voltage can be adjusted to motor rated input voltage. This function is useful when rated motor voltage is lower than the rated inverter output voltage. 110% means over-modulation in PWM causing a higher output voltage compared to 100% of rated output voltage.

## 5.2.11 Frequency Reaching Signal

This function is used to operate the electric motor brake. The output signal is generated once the drive reaches output frequency level for enough flux gain in the motor and ready to release the brake. See Section 5.2.4 for more information regarding the brake and the Multi-Function Output.

**F18:** Brake Release Frequency (Factory Default:  $F_{12} + 0.01$  Hz.)  
Range: 0.01 -  $F_9$  Hz

**F19:** Frequency Reaching Signal Band (Factory Default: 0.0 Hz.)  
Range: 0.0 - 30.0 Hz

Fig. 5.2.11: Brake Release Functions Diagram

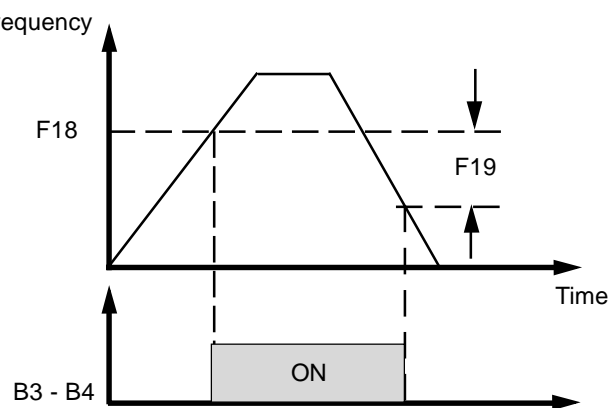

## 5.2.12 Braking

**F20:** Stop Mode (Factory Default: 2: Immediate Stop)

Range: 0: Ramp to Stop (Not recommended for hoist motion)

1: DC Injection Brake

2: Immediate Stop

3: Delay on Brake

**F21:** Brake Delay Time (Factory Default: 0.0 sec.)

Range: 0.0 - 25.0 sec.

Stop Mode is set by the Motion Select Macro. Its value is 2: Immediate Stop if hoist motions are selected. Its value is 0: Ramp to Stop if traverse motion is selected.

### RAMP TO STOP

Ramp to Stop is the default value for traverse applications. The drive output ramps down to a stop when the Run command is released. Not recommended for use with worm gear speed reducers. RAMP TO STOP IS NOT ADVISED FOR HOIST MOTION.

### DC INJECTION BRAKE

See Section 5.3.6 for an explanation of this feature.

### IMMEDIATE STOP

Immediate Stop is the default value for hoist applications. The drive output turns off when the Run command is released.

### DELAY ON BRAKE

Delay on Brake works like Ramp to Stop, except at the end of the ramp period the Brake does not set immediately, it waits for a period equal to **[H21]**, Brake Delay Time.

### 5.2.13 Upload / Download from Keypad and Set Factory Defaults

**F22:** Parameter Read from Main Memory to Keypad  
Range: 0: Inactive (Factory Default: 0:Inactive)  
1: Active

**F23:** Parameter Write from Keypad to Main Memory  
Range: 0: Inactive (Factory Default: 0:Inactive)  
1: Active

By setting **F22** Active, all drive data, including fault history, will be uploaded to the Electronically Programmable Read Only Memory (EPROM) of the keypad. This can be a useful way to store drive status at the time of fault.

By setting **F23** to Active, all drive data stored in the keypad will be downloaded to the drive. This can be a useful option when copying a set of parameters from one drive to another.

**F24:** Initialize Parameters by Factory Settings  
Range: 0: Inactive (Factory Default: 0:Inactive)  
1:Active

If set to Active, the factory initial parameters will be downloaded to the drive.

## Section 5.3: Advanced Level Functions

### 5.3.1 Frequency Reference Source

**H1:** Command Frequency Selection Method (Factory Default: 0: Keypad)  
Range: 0: Keypad  
1: Terminal

In order for the drive to receive its speed reference from an analog source instead of the keypad, **H1**, Command Frequency Source, must be set to 1: Terminal.

### 5.3.2 User V / F Pattern (See Section 5.2.8 for H2, H3, H4, and H5)

### 5.3.3 Analog Frequency Control

**H6:** Analog Input Mode (Factory Default: 0: Voltage)  
Range: 0: Voltage Input  
1: Current Input  
2: Voltage + Current Input

**H7:** Analog Input Filter Gain (Factory Default: 100%)  
Range: 1 - 200 %

**H8:** Analog Input Gain (Factory Default: 100%)  
Range: 50 - 100 %

**H9:** Analog Input Bias (Factory Default: 5%)  
Range: 0 - 100 %

**H10:** Analog Input Direction (Factory Default: 0: Direct)  
Range: 0: Direct  
1: Inverse

In order for the drive to receive its speed reference from an external source instead of the keypad, **H1** must be set to 1: Terminal. **H6**, Analog Input Mode is used to select the analog frequency reference method. If a 0 ~ 10 VDC signal is the desired source of reference, then 0: Voltage should be selected. If a 4 ~ 20 mA. signal is the source of reference, then 1: Current should be selected. When both of the signals are used, then 2: Voltage + Current should be selected.

The **H7**, Analog Input Filter Gain, can be adjusted to set the responsiveness of the drive output. To obtain a faster response, the gain in **H7** is set to a lower value and vice versa, see Fig. 5.3.1.

Fig. 5.3.1: Analog Control Source Diagrams

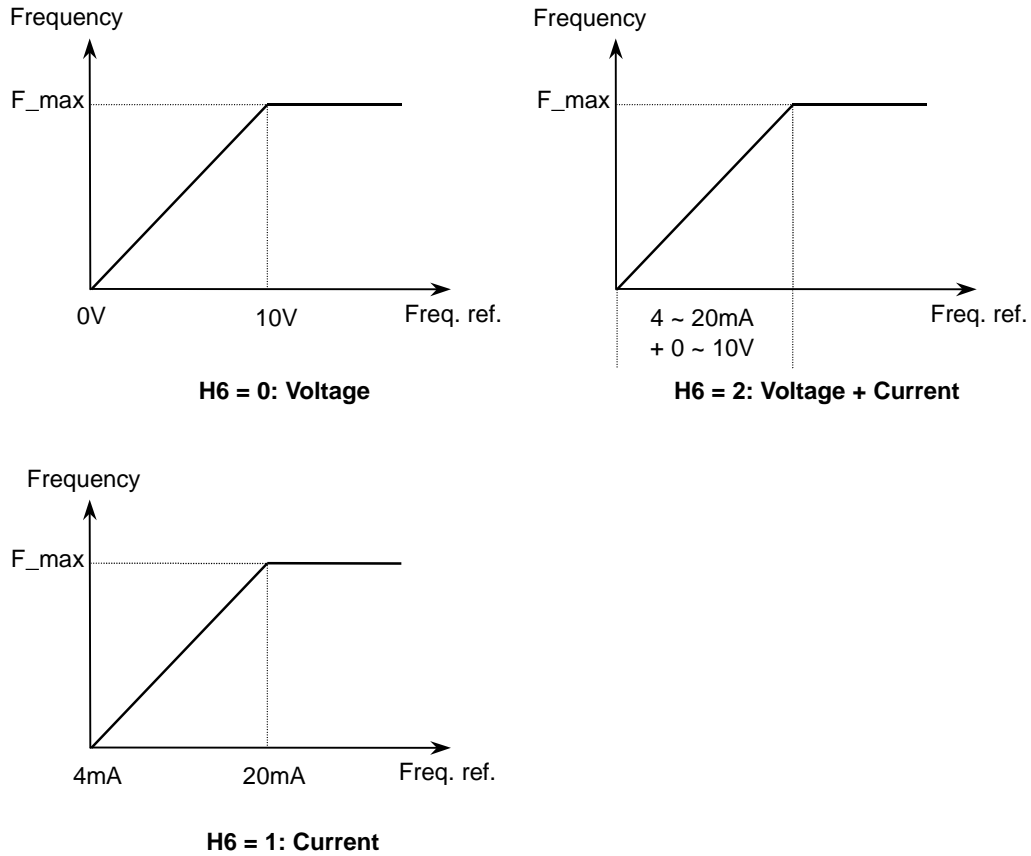

**H8**, Analog Input Gain, establishes the correct ratio between the analog input signal and its maximum speed reference of the drive. For example, if the drive needs to accept +5 VDC analog signal as its maximum speed reference instead of +10 VDC, by setting **H8** to 50% the drive will calculate its maximum analog input as  $10 \text{ VDC} \times (0.5) = 5 \text{ VDC}$ . This establishes a +5 VDC input signal as the maximum speed reference. See Fig. 5.3.2.

Fig. 5.3.2: Analog Input Gain

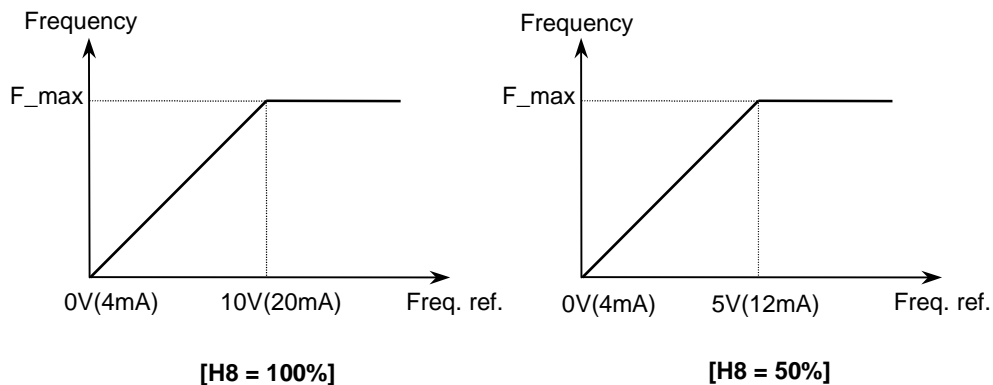



**H8** is used to set the ratio between the maximum analog input signal and the maximum frequency reference. **H9**, Analog Input Bias, establishes the ratio between the minimum analog input signal and the minimum frequency reference. For example, if **H9** is set at 50% and the analog input signal is 0 VDC, then the drive will calculate its minimum speed reference (maximum speed x **H9**) which becomes half of the set maximum frequency.

Fig. 5.3.3: Analog Input Bias

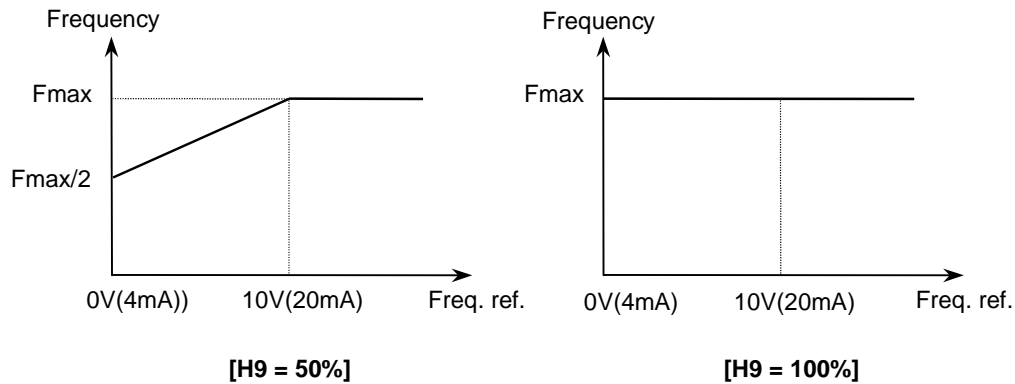

**H10**, Analog Input Direction, establishes the analog input versus frequency reference slope that is either a positive or negative slope. When set to 0: Direct the analog command signal (0 ~ 10VDC or 4 ~ 20mA) represents an increasing or positive slope. When set to 1: Inverse then the signal (0 ~ 10VDC or 4 ~ 20mA) represents a decreasing or negative slope. See Fig. 5.3.4.

Fig. 5.3.4: Analog Reference Slope

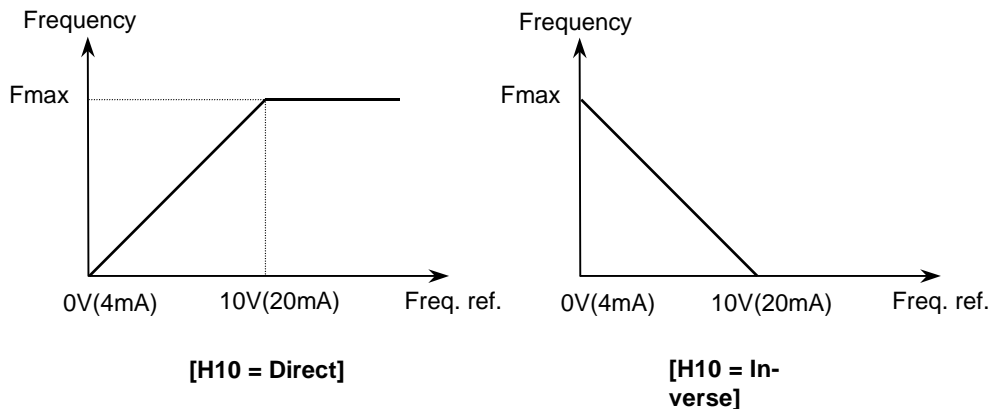

### 5.3.4 Maximum / Minimum Operating Frequency

**H11:** Maximum Operating Frequency  
Range: 0.0 - F9 Hz. (Factory Default: 60.0 Hz)  
**H12:** Minimum Operating Frequency (Factory Default: 0.0 Hz)  
Range: 0.0 - F9 Hz.

The output frequency range of the drive is limited to the values set in H11 and H12. See Fig. 5.3.5.

Fig. 5.3.5: Operational Maximum Frequency

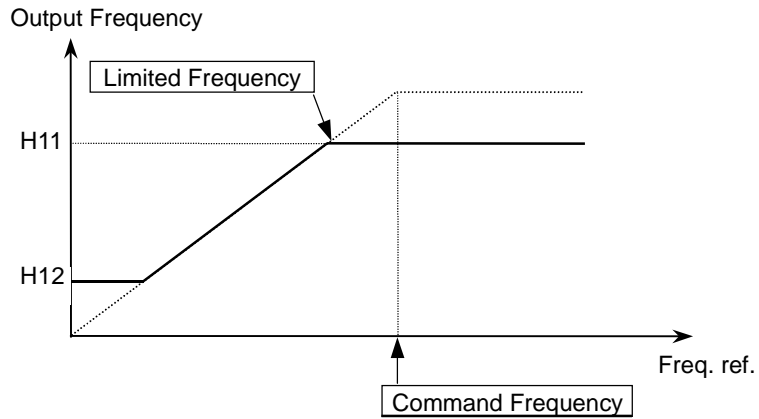

### 5.3.5 Frequency to Bypass

**H13:** Frequency to Bypass (Factory Default: 0.0 Hz)

Range: 0.0 - F9 Hz.

**H14:** Frequency Bandwidth To Bypass (Factory Default: 0.0 Hz)

Range: 0.0 - 30.0 Hz.

Undesirable resonance and vibration on the motor shaft of the hoist or crane could occur within a certain frequency range due to the structure of the machine. This frequency bypass function is used to lock that frequency band out of operation. Most of the time, this phenomenon occurs only at a specific frequency. The jump frequency also has its own bandwidth. This is a span of the particular bypass frequency selected. See Fig. 5.3.6.

Fig. 5.3.6: Frequency Bypass

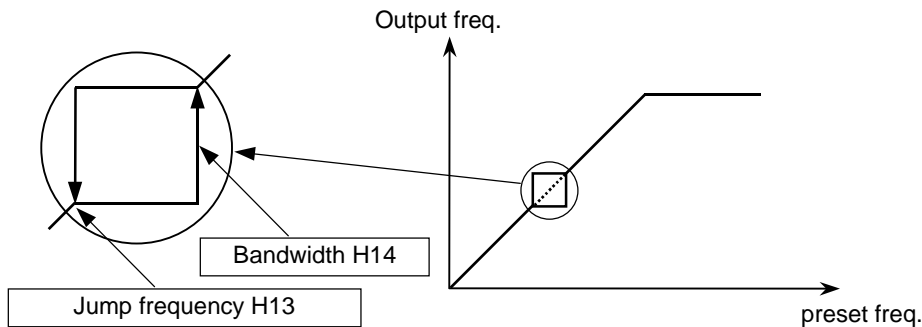

### 5.3.6 DC Braking

<b>H15:</b>	DC Braking Frequency	(Factory Default: 5.0 Hz.)
	Range:0.0 - 20.0 Hz	
<b>H16:</b>	DC Braking Voltage	(Factory Default: 5%)
	Range:0 - 20 %	
<b>H17:</b>	DC Braking Block Time	(Factory Default: 0.5 sec.)
	Range:0.0 - 5.0 sec.	
<b>H18:</b>	DC Braking Time	(Factory Default: 2.0 sec.)
	Range:0.0 - 20.0 sec.	

This function can be used to bring the hoist to a quick stop without the use of Dynamic Braking Resistors. **H15** sets the starting frequency where the DC Injection begins. **H17** is the time between the DC Injection command and the actual desired moment of DC injection output. **H18** is the total braking time. **H16** is the level of DC Injection Voltage Output (% of rated voltage). The DC Injection Braking can be selected by selecting DC Brake in **F21**. This method can also be used to build up magnetic flux in the hoist motor for smooth starting motion. See Fig. 5.3.7.

Fig. 5.3.7: DC injection Braking

The hoist decelerates down to the DC Braking Frequency level first before DC Braking. Drive stops producing any Output voltage for t1. Drive will produce the DC braking voltage for t2.

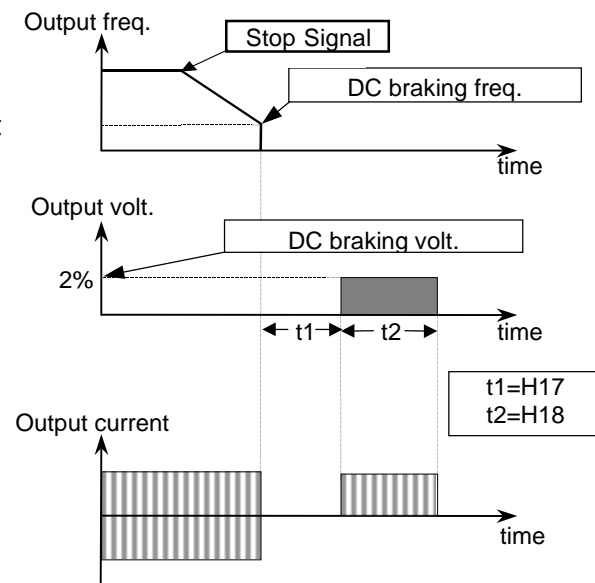

### 5.3.7 Motor Data

In order for the drive to operate the motor with slip compensation, the name plate data of the motor must be programmed correctly. Without this data, the drive output torque can be insufficient and could cause the motor to overheat in some instances.

**H19:** Slip Compensation (Factory Default: 0:Inactive)  
Range: 0: Inactive  
1: Active

**H19**, Slip Compensation, is selected to compensate the motor for inherent slippage. By selecting this function, the drive will hold a constant speed range by generating a higher frequency output to the motor.

**H20:** Rated Slip of the Motor (Factory Default: 3.0 Hz)  
Range: 0.0 - 5.0 Hz.

**H21:** Rated Current of the Motor (FLA) (Factory Default: See Table 5.2.2)  
Range: 0.1 - 60.0 A

**H22:** No Load Current of the Motor (Factory Default: See Table 5.2.2)  
Range: 0.1 - 60.0 A

Refer to Section 3.3 for formulas to calculate these motor parameters.

### 5.3.8 Auto Restart

- H23:** Retry Number (Factory default: 0)  
Range: 0 - 10 times
- H24:** Retry Time (Factory default: 0.5 sec.)  
Range: 0.0 - 10.0 sec.
- H25:** Retry Mode (Factory default: 0)  
Range: 0: Non-operation during LV fault and retry  
1: Non-operation during LV fault  
2: Non-operation during retry  
3: Driving in all faults

These functions are used so the drive can reset itself automatically from all drive faults except Low Voltage or BX fault. The operator can set the maximum number of auto-restart trials through **H23**, Retry Number, and Retry Time (a waiting time before the next restart attempt) through **H24**. The Auto-Restart works in conjunction with the Speed Search Mode, see Section 5.3.11. See Fig. 5.3.8.

Fig. 5.3.8: Auto Restart Function

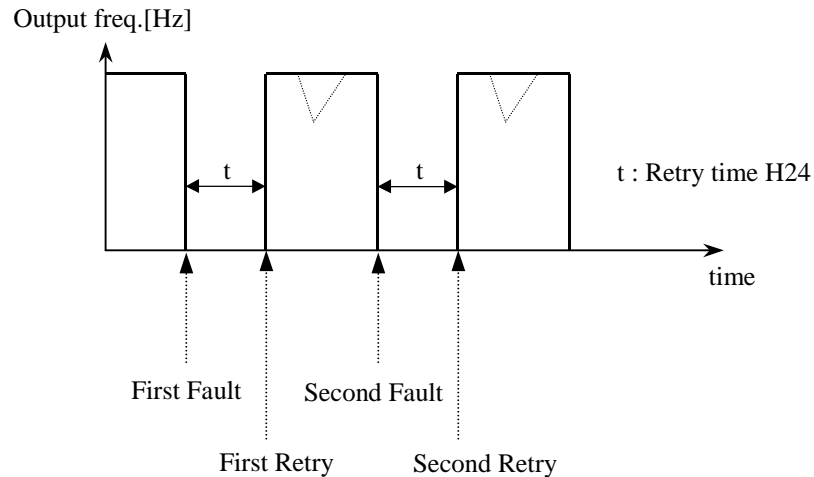

### 5.3.9 Stall Prevention

**H26:** Stall Prevention Mode Selection (Factory Default: 0:Disable)

Range:0: Disable

- 1: Stall prevention during acceleration
- 2: Stall prevention during steady speed
- 3: Stall prevention during acceleration and steady speed
- 4: Stall prevention during deceleration
- 5: Stall prevention during acceleration + deceleration
- 6: Stall prevention during deceleration + steady speed
- 7: Stall prevention during acceleration + deceleration + steady speed

**H27:** Stall Prevention Level (Factory Default Setting : 150%)

Range:30 - 150%

**NOTE: DO NOT USE STALL PREVENTION ON HOIST MOTION.  
GREAT CARE SHOULD BE EXERCISED WHEN SELECTING DECELERATION  
(PARAMETER VALUES 4 THROUGH 7) AS A STALL PREVENTION MODE WHEN  
USING A DYNAMIC BRAKING RESISTOR.**

These functions are used to prevent the traverse faults that occur due to load fluctuation by reducing the inverter output frequency until the motor current level decreases below **H27**, Stall Prevention Level. Once the motor current level satisfies the value of **H27**, then the drive will increase its output frequency to its set point.

#### ACCELERATION

If the output current of the drive has reached the stall prevention level during drive acceleration, the drive will stop accelerating until the current level is reduced below **H27** before it resumes acceleration to a set frequency command. See Fig. 5.3.9.

#### STEADY SPEED

If the output current of the drive has reached the stall prevention level during a steady speed period, due to load fluctuation, the drive will then reduce its output frequency until the output current level is reduced below **H27**. The drive will then increase its output frequency to the set frequency command. See Fig. 5.3.10.

#### DECELERATION

If the DC BUS voltage reaches the Over Voltage fault level (790 VDC for the 460 VAC class, 390 VDC for the 230 VAC class) during deceleration, the drive will stop further deceleration until DC Bus voltage drops below the fault level. See Fig. 5.3.11.

Fig. 5.3.9: Stall Prevention during Acceleration

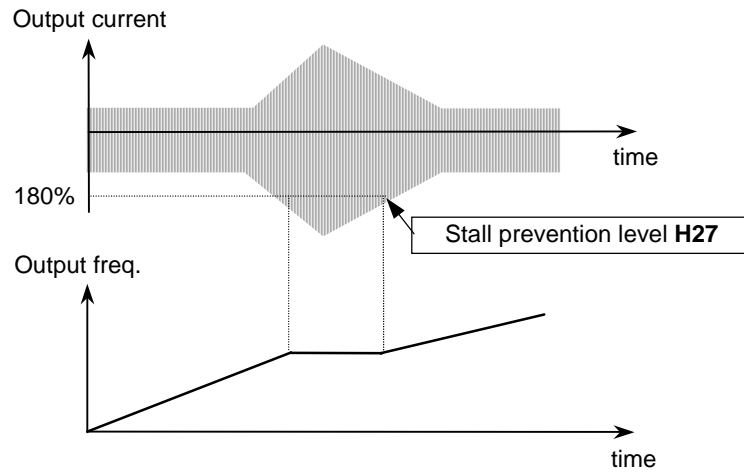

Fig. 5.3.10: Stall Prevention during Steady Speed

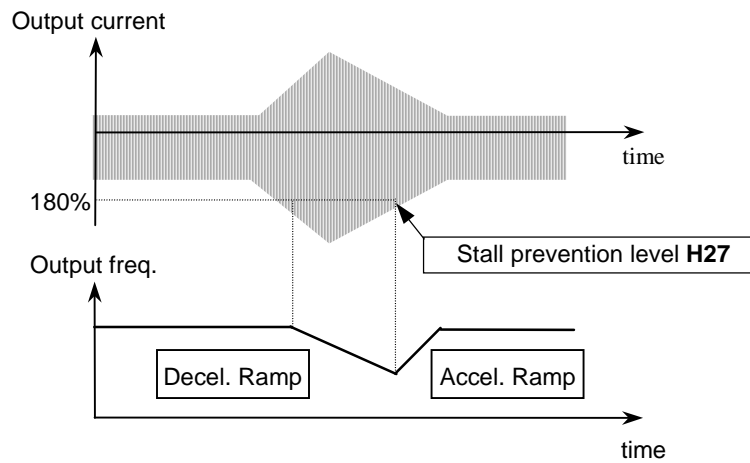
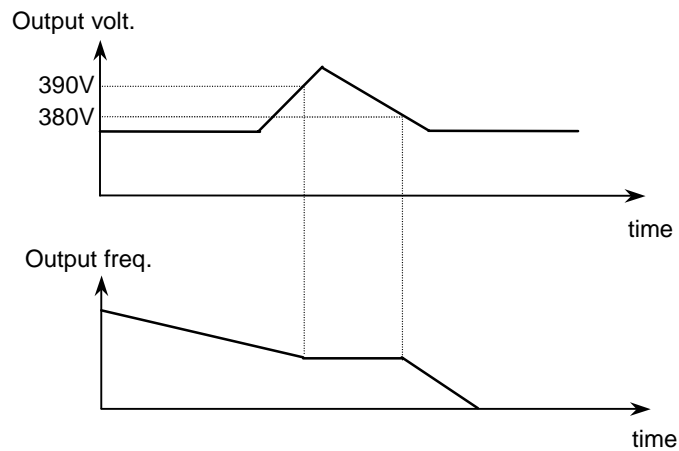

Fig. 5.3.11: Stall Prevention during Deceleration-230V Class





### 5.3.10 Drive and Motor Protections

#### OVERLOAD

**H28:** Over Load Level (Factory Default: 150%)

Range: 30 - 150%

**H29:** Over Load Time (Factory Default: 10.0 Sec.)

Range: 0.1 - 30 sec.

This function is used to provide a motor overload warning. When the output current of the drive has reached the value of **H28**, Overload Level, the Multi-Function Output terminal will be activated, if programmed. However, for an Overload Signal to occur, **H28** and **H29**, Overload Time, must be set to the desired trip value. As there is only one Multi-Function Output available, there will be no brake control, therefore it is advised this function NOT be used in hoist applications. See Fig. 5.3.12.

Fig. 5.3.12: Multi-Function Output response to Overload Parameter

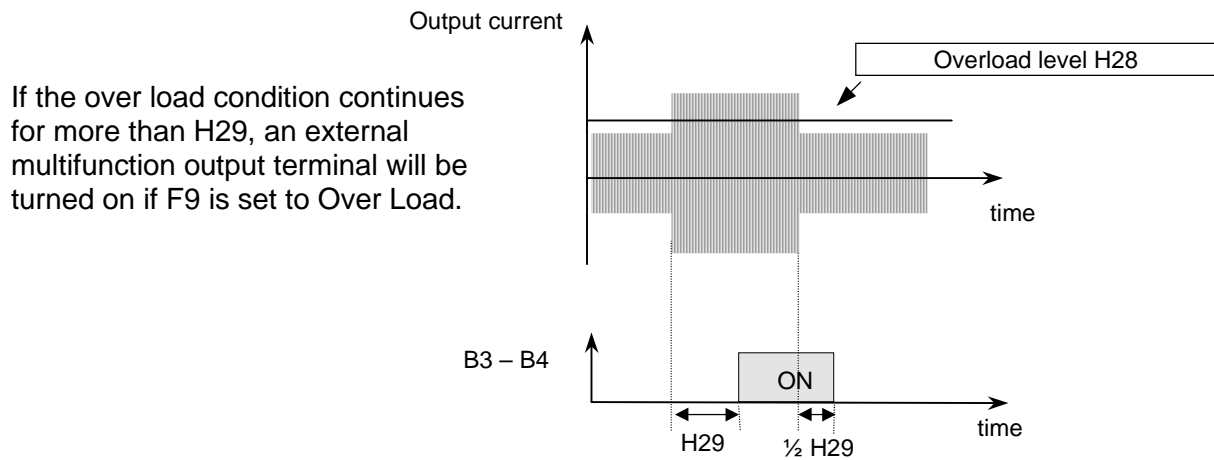

## OVERCURRENT LIMIT TIME (OLt)

**H30:** Overcurrent Limit Time  
Range: 0.0 - 60.0 sec.

(Factory Default: 0.1 sec. Hoist  
30.0 sec. Traverse)

When output current of the drive reaches 180% of drive rated output current for a continuous time set in **H30**, Overcurrent Limit Time, an OLt Fault will occur and the motor will stop. See Fig. 5.3.13.

Fig. 5.3.13: Overcurrent Limit Drive Response.

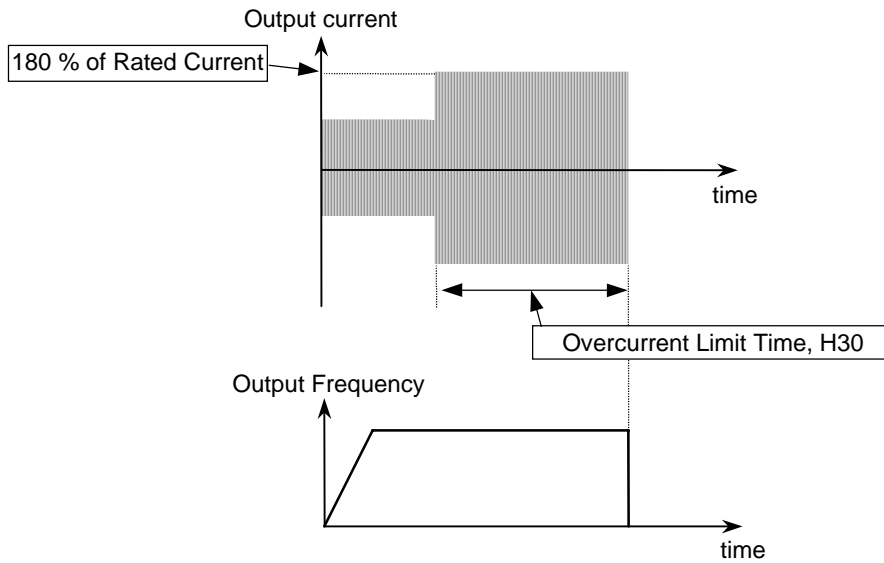

## ELECTRONIC THERMAL DETECTION (EtH)

**H31:** EtH Selection (Factory Default: 1: Active)  
Range: 0: Inactive  
1: Active

**H32:** EtH Level (Factory Default: 150%)  
Range: 30 - 150%

**H33:** Motor Type Selection (Factory Default: 0: General)  
Range: 0: General  
1: Special

This function is used to compensate for excessive motor heat generated during continuous low frequency operation. This is especially true if the capacity of the hoist motor is lower than that of the inverter. To prevent the motor from overheating, the EtH level must be set according to the provided formula.

$$\text{EtH level (\%)} = K \times (\text{Motor rated current} / \text{Inverter rated current}) \times 100\%$$

(K = 1.0 for 50Hz Input Frequency, K = 1.1 for 60 Hz Input Frequency)

Once the EtH level is found, then the motor type of the hoist must be determined. There are two electronic thermal characteristics, one is a General, a standard AC induction motor, the other is Special, for a motor containing a forced air blower. Once the correct values are programmed, the drive will determine the EtH time for either the General or Special motor.

### 5.3.11 Instantaneous Power Failure and Speed Search

<b>H34:</b> IPF Restart	(Factory Default: 0: Inactive Hoist 1: Active Traverse)
Range: 0: Inactive 1: Active	
<b>H35:</b> Speed Search Accel. Time	(Factory Default: 2.0 sec.)
Range: 0.1 - 10.0 sec.	
<b>H36:</b> Speed Search Decel. Time	(Factory Default: 2.0 sec.)
Range: 0.1 - 10.0 sec.	
<b>H37:</b> Speed Search Block Time	(Factory Default: 0.0 sec.)
Range: 0.0 - 5.0 sec.	

#### SPEED SEARCH

The Speed Search Mode is used when the drive needs to be restarted while a motor is coasting. This function is especially important if the motor has a large load inertia. **IMPORTANT:** Without speed search, restarting into a coasting motor can result in over current in the IGBT's.

#### INSTANTANEOUS POWER FAILURE (IPF)

This function is used to initiate the automatic restart mode after an IPF of over 15 msec. in duration. After the drive resets itself from an IPF it begins to search for the current speed of the coasting motor following a time period equal to **H37**, Speed Search Block Time. Once the drive determines the speed of the motor, it then re-accelerates for a time equal to **H35**, Speed Search Accel. Time. The drive decelerates for a time equal to **H36**, Speed Search Decel. Time, to allow the drive output to match the decelerating motor speed. The drive then accelerates to the previous set reference frequency. **H35**, **H36**, and **H37** must be set, considering the moment of inertia and the magnitude of torque demand of the load.

Fig. 5.3.14: IPF Function

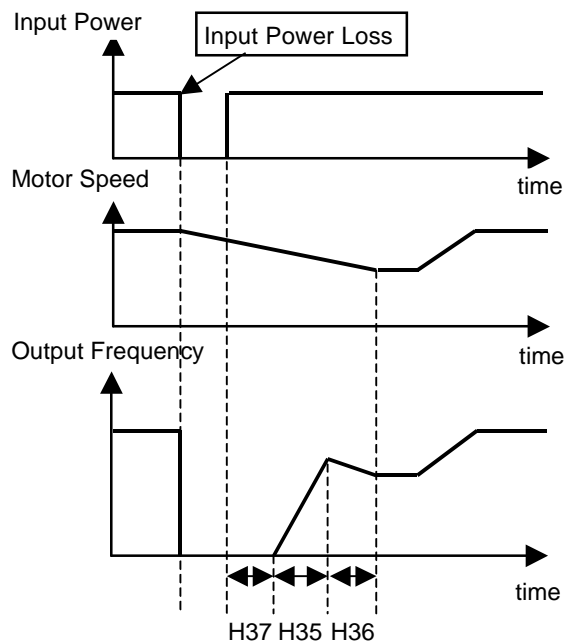

### 5.3.12 Restart After Reset

**H38:** Reset Restart  
Range: 0: Inactive  
1: Active

(Factory Default: 0: Inactive)

When Reset Restart is set to Active, the drive can be selected to automatically initiate auto-restart mode after a manual reset. If this parameter is set to Inactive, the drive must receive a RUN command after the manual reset.

Fig. 5.3.15: Reset Restart (H38) Inactive

When Reset Restart function is inactive, F (UP/FORWARD) Pendant buttons must be released, then pressed again after a manual reset in order to run the drive again.

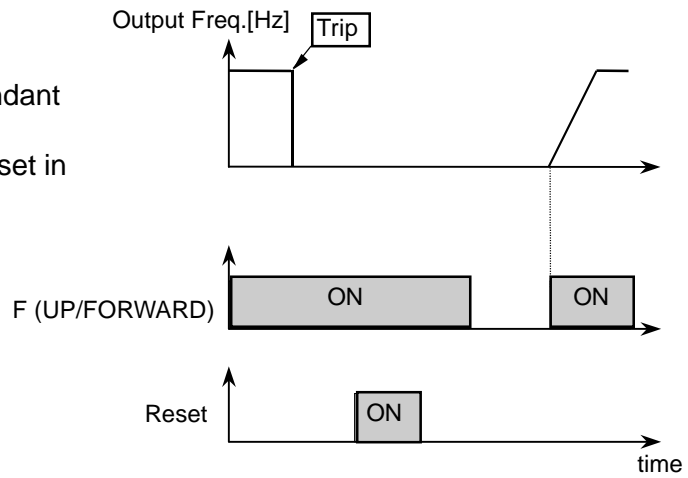

## INPUT POWER DETECTED AUTO-RESTART

**H39:** Power On Start  
Range: 0: Inactive  
1: Active

(Factory Default: 1: Active)

With either the F (UP/FORWARD) input terminal or R (DOWN/REVERSE) input terminal is energized and the input power is restored, the drive will initiate the auto-restart automatically when **H39**, Power On Start, is set to Active. See Figs. 5.3.16 and 5.3.17.

Fig. 5.3.16: Power On Start Inactive

When Power On Start is set Inactive, the drive will not run at the time of the Power Up sequence. An external Run Command must be given in order to restart the drive.

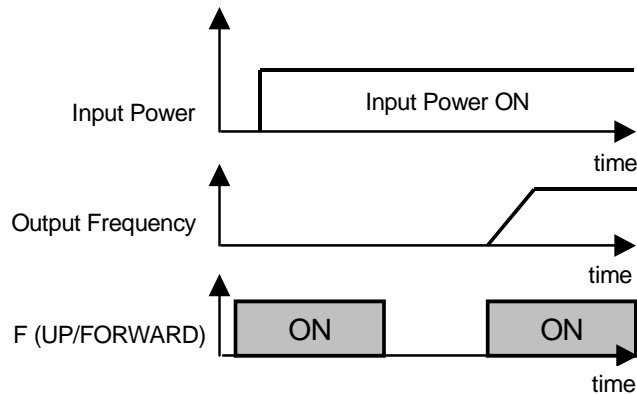
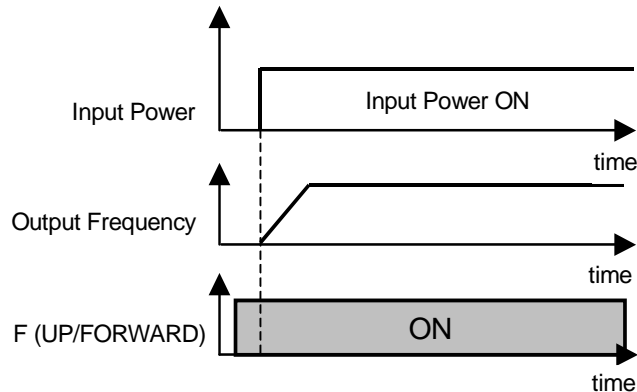

Fig. 5.3.17: Power On Start Active

When Power On Start is set Active, the drive will run at the time of the Power Up sequence.



### 5.3.13 Carrier Frequency

**H40:** Carrier Frequency Selection  
Range: 3 - 15 kHz.

(Factory Default: 3 kHz.)

This is the IGBT switching frequency. This function is generally used to prevent harmonic resonance in machines and motors. If this PWM carrier frequency is set at an appropriate level, both electronic noise and current leakage are reduced. If this frequency is set too high, there can be an increase in audible noise. Generally, the carrier frequency is set to a lower value in high ambient temperature environments.

### 5.3.14 Multi-Meter Output for Current, Voltage, and Frequency

**H46:** Multi-Meter Mode Selection (Factory Default: 0:Frequency)

Range: 0: Frequency  
1: Output Voltage  
2: Output Current

**H47:** Multi-meter Adjustment (Factory Default: 100%)

Range: 0 - 120 %

The SV100 Frequency Drive has an FM terminal which can be programmed to generate either a drive voltage, current or frequency output measured as a 0 ~ 10VDC pulse signal. The measurement selection can be programmed in **H46**. When a different ratio between FM output and actual drive voltage/current/frequency measurement is required, the value of **H47** can be set to meet the ratio requirement.

Fig. 5.3.18: Multi-Meter Output

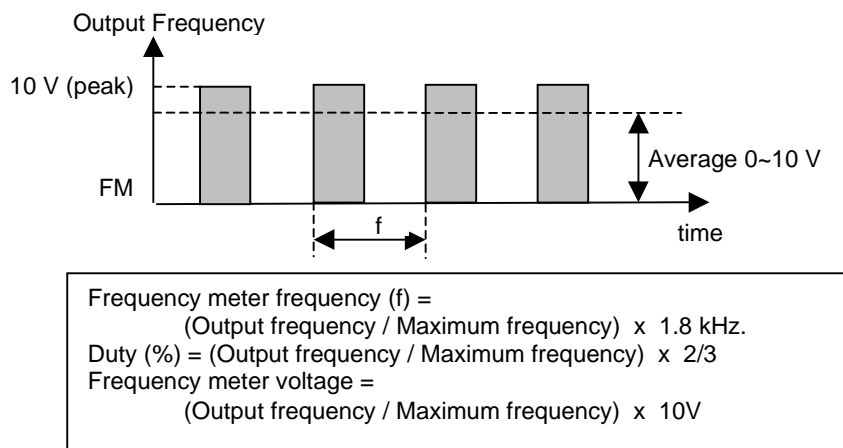

### 5.3.15 Motor Phase Loss

**H49:** Phase Loss Check Time (Factory Default: 50 msec.)

Range: 0 - 5000 msec.

The SV100 Frequency Drive has a Phase Loss Detection feature. If the drive detects that there is not enough current output at one or more of the motor terminals the drive will fault on Phase Loss (*PHF*). Setting the value of **H49**, Phase Loss Check Time, to zero will disable the phase loss detection feature. See Tables 4.1.1 and 4.1.2.

### 5.3.16 Reverse Plugging

**H50:** Reverse Plugging Enable (Factory Default: 0:Inactive)

Range:0: Inactive

1: Active

**H51:** Reverse Plugging Acceleration Time (Factory Default: 1.5 sec.)

Range:0 - 999 sec.

**H52:** Reverse Plugging Deceleration Time (Factory Default: 1.5 sec.)

Range:0 - 999 sec.

Reverse plugging allows for a smooth and quick transition from one direction to the opposite direction with minimal load swing.

**NOTE:** To be used for traverse applications only.

Motors may need to be oversized from standard motor size calculations by approximately 50 % to be able to handle the extra current required to be able to reverse plug motors with loads near equipment capacity.

Fig. 5.3.19: Reverse Plugging

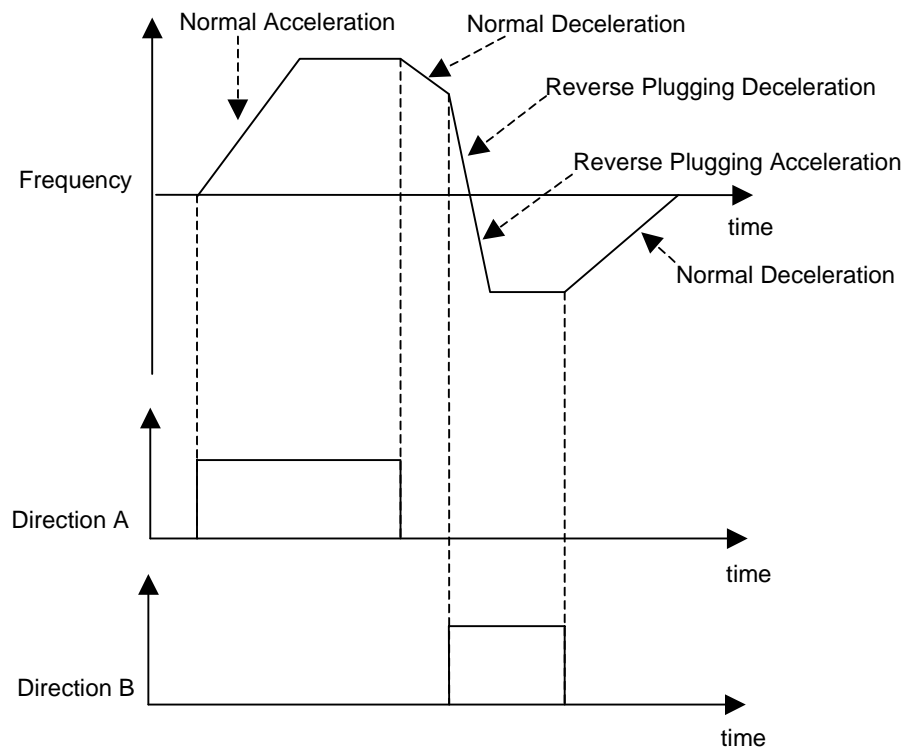



# **Chapter 6: Maintenance**

**Section 6.1: Maintenance**

**Section 6.2: Precautions**

**Section 6.3: Routine Inspection**

**Section 6.4: Visual Inspection**

## 6.1 Maintenance

SV100 Series can be influenced by temperature, humidity, and vibration. To avoid any possible uncertainty, the drive must be installed and maintained properly by trained personnel.

## 6.2 Precaution

Only certified personnel familiar with the equipment are permitted to install, operate and maintain the drive.

Observe the Charge LED on the drive to be sure of complete power dissipation.

The output voltage of your SV100 drive can only be measured by a rectifier voltage meter (such as RMS meter). Other instruments such as a digital meter will read an incorrect value due to the high switching PWM frequency.

## 6.3 Routine Inspection

Check Input-Line Voltage to the drive for any fluctuation.

Check the Cooling Fan. If there is any abnormal noise, replace.

Check for any physical vibration to the drive.

Check the temperature for any overheating.

## 6.4 Visual Inspection

Any loose screws, nuts, or wires?

→ Tighten or replace.

Any deposit of dust or foreign material in the AC Drive or Cooling Fan?

→ Clean off the dust or foreign material.

Are any connectors disconnected from printed circuit boards?

→ Re-insert the connector.

Inspect for corrosion.

→ Clean where possible or replace.

# Appendix

Appendix Fig. 1: Sample Traverse Wiring Diagram

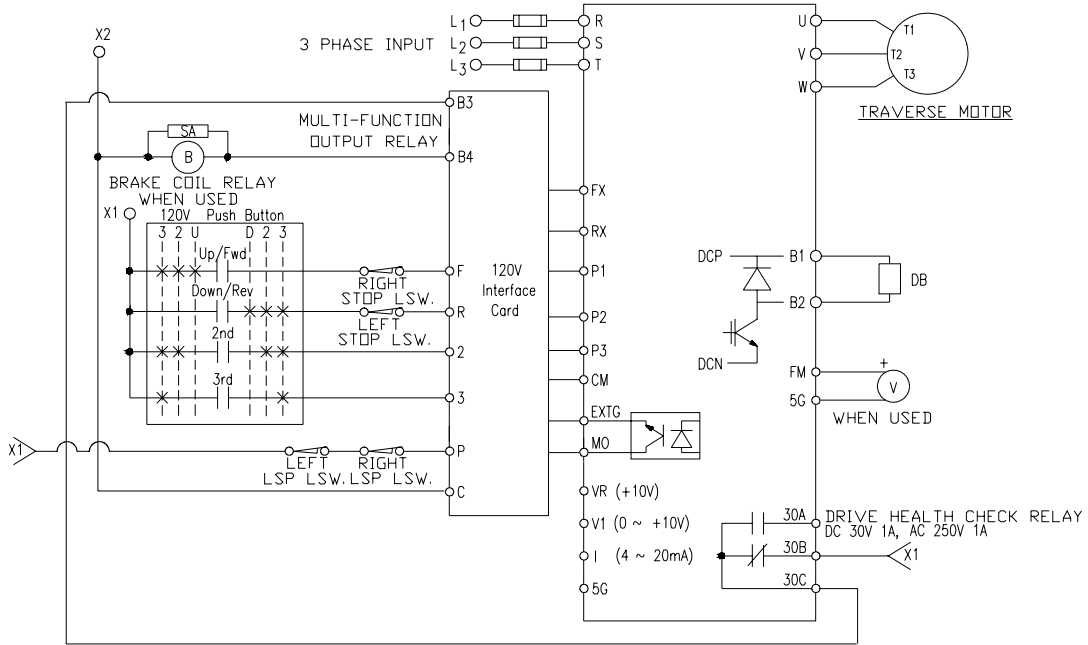

Traverse Wiring Diagram Example: Multi-Function Input F6 set for 7: Low Speed LS

Appendix Fig. 2: Sample Hoist Wiring Diagram with Analog Control

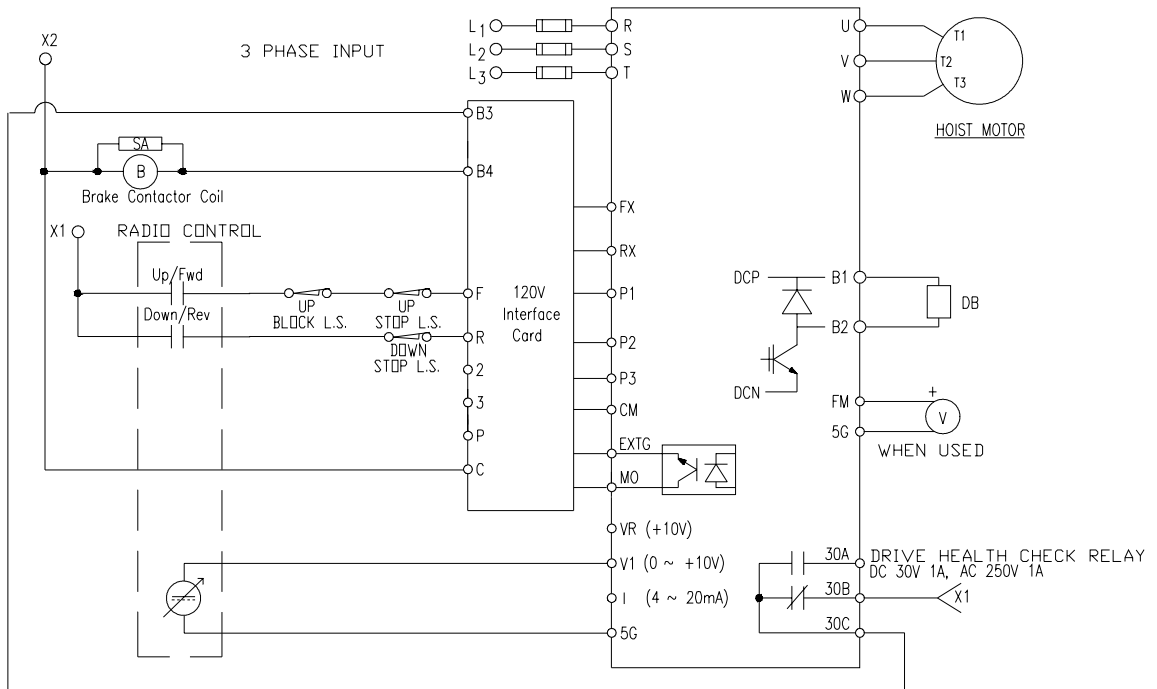

Hoist Wiring Diagram Example: Advanced Level H1 set for 1: Analog

Appendix Fig. 3: 2 Speed Control

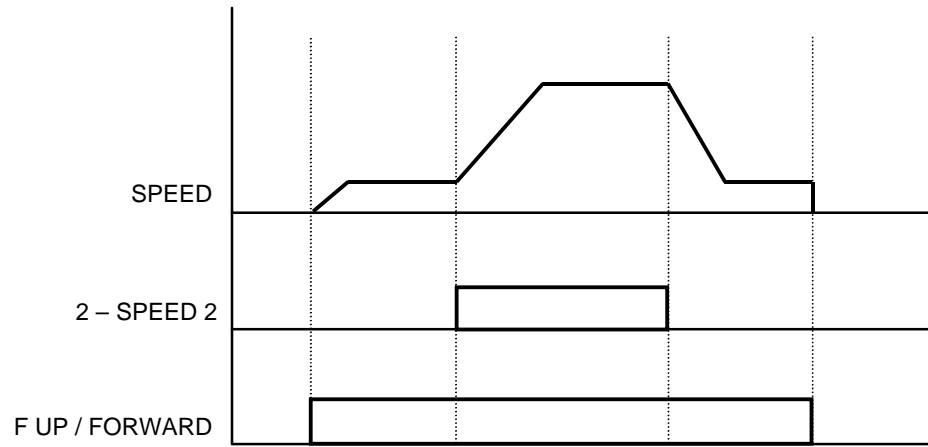

Appendix Fig. 4: 2 Step Infinitely Variable Speed Control

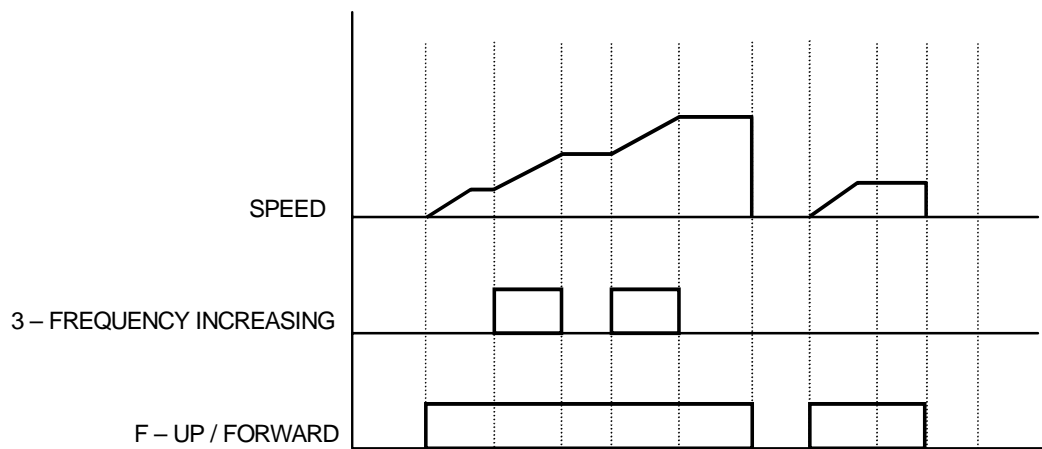

Appendix Fig. 5: 3 Speed Control

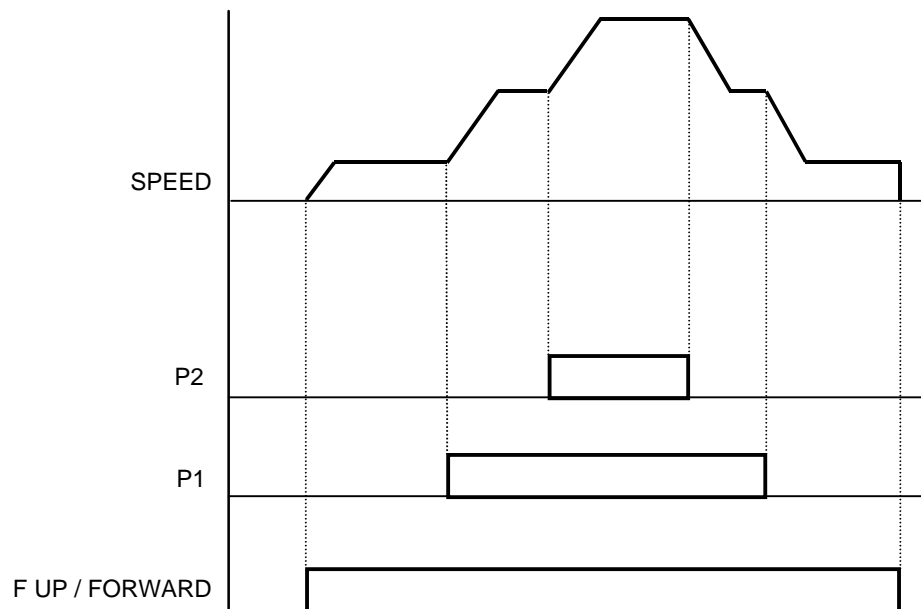

Appendix Fig. 5: 3 Step Infinitely Variable Speed Control

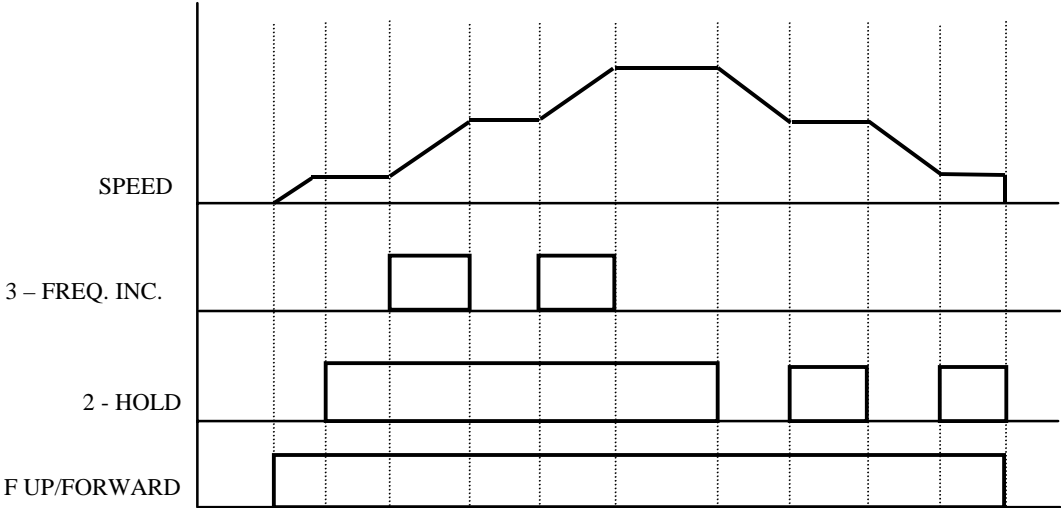







414 W. BROADWAY AVE.  
MUSKEGON, MI 49443-0769

Phone: 877 226-6278  
Fax: 231 733-3223

P.O. BOX 1000  
FORREST CITY, AR 72335

Phone: 800 999-6318  
Fax: 800 766-0223

# WARRANTY

## WARRANTY AND LIMITATION OF REMEDY AND LIABILITY

A. Seller warrants that its products and parts, when shipped, and its work (including installation, construction and start-up), when performed, will meet applicable specifications, will be of good quality and will be free from defects in material and workmanship. All claims for defective products or parts under this warranty must be made in writing immediately upon discovery and, in any event, within two (2) years (or as otherwise provided) from shipment of the applicable item unless Seller specifically assumes installation, construction or start-up responsibility. All claims for defective products or parts when Seller specifically assumes installation, construction or start-up responsibility, and all claims for defective work must be made in writing immediately upon discovery and, in any event, within two (2) years (or as otherwise provided) from completion of the applicable work by Seller, provided, however, all claims for defective products and parts must be made in writing no later than thirty (30) months after shipment. Defective items must be held for Seller's inspection and returned to the original f.o.b. point upon request. THE FOREGOING IS EXPRESSLY IN LIEU OF ALL OTHER WARRANTIES WHATSOEVER, EXPRESS, IMPLIED AND STATUTORY, INCLUDING, WITHOUT LIMITATION, THE IMPLIED WARRANTIES OF MERCHANTABILITY AND FITNESS.

B. Upon Buyer's submission of a claim as provided above and its substantiation, Seller shall, at its option, either (i) repair or replace its product, part or work at either the original f.o.b. point of delivery or at Seller's authorized service station nearest Buyer or (ii) refund an equitable portion of the purchase price.

C. This warranty is contingent upon Buyer's proper maintenance and care of Seller's products, and does not extend to normal wear and tear. Seller reserves the right to void warranty in event of Buyer's use of inappropriate materials in the course of repair or maintenance, or if Seller's products have been dismantled prior to submission to Seller for warranty inspection.

D. The foregoing is Seller's only obligation and Buyer's exclusive remedy for breach of warranty, and is Buyer's exclusive remedy hereunder by way of breach of contract, tort, strict liability or otherwise. In no event shall Buyer be entitled to or Seller liable for incidental or consequential damages. Any action for breach of this warranty must be commenced within two (2) years (or as otherwise provided) after the cause of action has accrued.