

The LNG Engineering Solution

10.2015

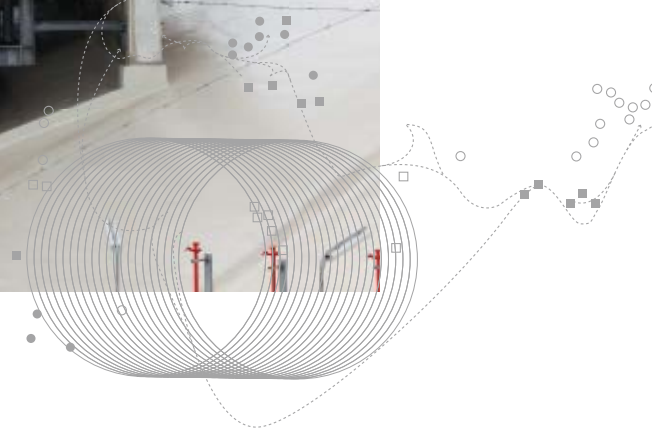

Partner of Experts



Liquefied Natural Gas

Liquefied natural gas (LNG) is purified natural gas containing more than 90% methane and cooled down to -164 to -161°C . In this state it is odourless, colourless, only slightly toxic and non-corrosive. It is more than 600 times more compact than in its gaseous state and weighs half as much as water. In the form of LNG, natural gas can be safely and cost-effectively transported by sea over long distances in special tankers. This makes it a significant alternative to pipeline-bound natural gas. Experts are of the opinion that LNG will be the fastest growing energy source in the next 20 years. Global reserves will presumably not be exhausted for many years.

New exportation methods have enabled additional gas sources to be opened up and states previously barred from this market on the basis of their location to enter the international gas business. Gas-rich countries, particularly in the Arabian and Asian regions, have been investing in liquefaction plants and port terminals for some years. The major LNG exporters are at present Qatar, Indonesia, Malaysia, Nigeria and Algeria. Recently Russia, Iran, Norway, Angola and Ivory Coast have also emerged as suppliers. Importing countries

are most notably Japan, India, South Korea, Pakistan, Chile and Brazil. Germany, Croatia and Poland may also import liquefied natural gas in the future.

Natural gas is extremely sensitive and easily inflammable. For this reason strict safety regulations must be observed and safety precautions taken in LNG trains, the large industrial plants for liquefying and regasifying natural gas.

STAHL CraneSystems is recognised internationally as an explosion protection specialist and is a world market leader in explosion protection technology. As a developer of numerous innovations in this field we have had perceptible influence on crane technology. The experience and knowledge gained in many decades, our own fundamental development, approvals from the Federal Physico-Technical Institute (PTB) and other inspection authorities in many countries around the world underline our particular expertise in major international projects.

All explosion-protected hoist and crane components and our systematic engineering solutions are based on our standard programmes. All parts, from motor and brake to control and switchgear, come from our in-house production with

certified quality assurance system. This guarantees the comprehensive high-quality explosion protection on which users, crane builders, systems builders and EPC contractors around the world have relied for decades.

The strict ATEX directives and international IECEx regulations on mechanical and electrical explosion protection are of course met.

→ Please order our brochure on the subject of expertise in explosion protection.





- LNG liquefaction plant with LNG hoists from STAHL CraneSystems
- LNG liquefaction plant
- LNG receiving terminal with LNG hoists from STAHL CraneSystems
- LNG receiving terminal
- Main LNG trade route

The engineering solution for LNG tanks

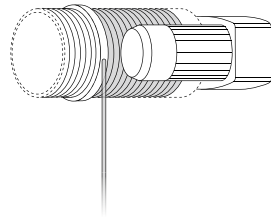

Safety Level 1

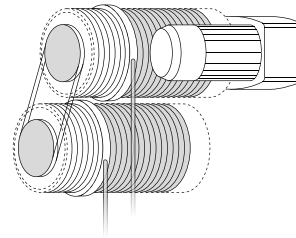

Safety Level 2

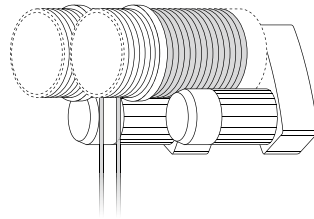

Safety Level 3A

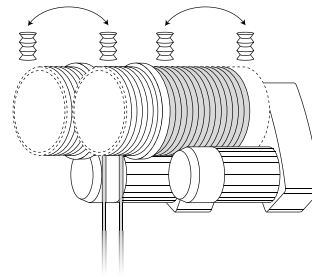

Safety Level 3B

STAHL CraneSystems offers suitable wire rope hoists for all safety levels

	Rope drums	Wire ropes	Hoist gear	Reeving	Floating and spring-loaded suspension
Safety Level 1	1	1	1	1/1	–
Safety Level 2	2	2	1	1/1	–
Safety Level 3A	2	2	2	1/1	–
Safety Level 3B	2	2	2	1/1	■

Safety Level 1

As a basic principle, LNG hoists are custom built to the individual specifications and requirements provided by systems builders and EPC contractors. Safety Level 1, the lowest level, employs explosion-protected hoists from STAHL CraneSystems' SH wire rope hoist programme or AS wire rope hoist programme, specifically designed for routine maintenance work on LNG trains. The modular principle enables various customer requirements to be met.

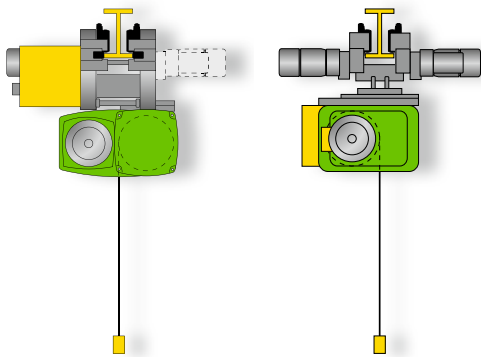

Safety Level 2

In Safety Level 2, two rope drums from the SH wire rope hoist programme, permanently connected by a chain, are driven by one motor. As an option, a fast action lock can be used to exchange the standard wire rope and the rope of the liquefied gas pump. The LNG pump's ropes can be taken up on one drum or on both drums in parallel as required. There is only one motor, hoist gear and brake. The modular principle enables various customer requirements to be met.

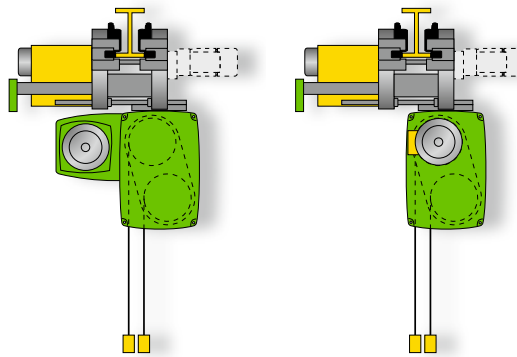

Safety Level 3A

The LNG hoist in Safety Level 3A is equipped with two separately driven motor-gear units running parallel, two rope drums and two brakes. The brakes are designed so that each one individually is able to brake or hold the load in an emergency. The brakes are synchronously controlled and act as service and holding brakes. The off-standard wire ropes permanently connected to the pump are attached to the rope drum of the LNG hoist by an optional fast action lock. Generally, lifting is performed by one load-bearing rope, the second rope runs parallel as a dead rope without load. In the unlikely event that one of the ropes should break, the second hoist can take over the load and continue lifting.

Safety Level 3B

LNG wire rope hoists in Safety Level 3B are masterpieces of STAHL CraneSystems' engineering and are regarded as the safest, most technically mature hoists in the world. As with the LNG hoists in Safety Level 3A, their construction is fully redundant. Increased safety is guaranteed by the additional floating and spring-loaded suspension. Only one rope acts as lifting rope when lifting the pump. The second hoist runs in parallel with a dead rope as backup. If the load rope should break during lifting, the second hoist takes over. However in safety level 3B, the hoist's floating and spring-loaded suspension absorbs the impact of the abrupt load change without jolting and ensures that the load's centre of gravity stays centred under the hoist. Lifting can continue without disruption and without damaging the valuable pump or any part of the system.

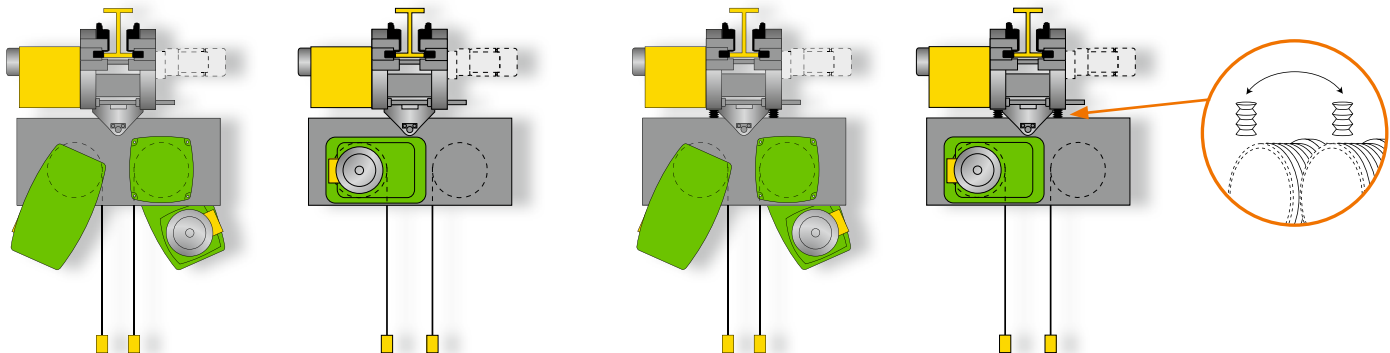



STAHL CraneSystems' LNG hoists are specifically designed for maintenance work on LNG tanks and are now employed successfully in many plants and terminals throughout the world. Thanks to the high-quality components, robust construction, corrosion-resistant paint and extensive additional equipment they are optimally suited for use in coastal areas with challenging climate conditions. The pumps in the tanks, which pump the liquefied natural gas into a pipe system at temperatures of -164 to -161°C , have to be lifted out of the 70 m high tanks and transported to the exterior up to five times a year for maintenance. The extreme conditions prevailing in the tank necessitate off-standard ropes permanently connected to the liquefied natural gas pump and remaining constantly in the tank. These ropes are attached to the rope drum and the hoist for maintenance work.

The experts in our engineering department develop these customised hoists individually for each systems builder and EPC contractor to meet their individual requirements, specifications, quality standards and national regulations. Manufacture in our factory with cost-effective standard components, strict test procedures and certified quality control guarantee optimum explosion protection. Thanks to our expertise, our first-class product portfolio, our systematic engineering solutions, international certification and customer-specific documentation we are able to complete projects cost-effectively, efficiently and in consistently high quality.

STAHL CraneSystems' LNG hoists are available in four safety levels, from Level 1 with increased safety to Level 2 with two rope drums running in parallel, Level 3A with redundantly built hoist and Level 3B with additional floating, spring-loaded suspension. STAHL CraneSystems' LNG hoists in Level 3B are regarded as the safest explosion-protected hoists currently on the market.

The facts

- Sophisticated engineering ideally adapted to your project
- Technically mature, using field-proven standard components
- International specialist for explosion-protected hoist and crane technology
- Our own production with certified quality assurance
- All customised solutions certified to ATEX directives or IECEx regulations
- Partner for official international procedures
- Full documentation



Explosion-protected hoist technology for LNG trains



For all other operations in LNG trains, STAHL CraneSystems offers the whole portfolio of explosion-protected standard wire rope and chain hoists, from individual custom-built solutions to complex engineering solutions. As an international specialist with experience and expertise in all the world's climate zones, we also supply safe and cost-effective hoist and crane technology for extreme climatic conditions such as saline air, offshore and onshore plants, extreme heat or Siberian cold. Even if maintenance and auxiliary cranes are shut down for long periods, you can rely on STAHL CraneSystems' technology to be fully operational and work reliably and safely. Spare parts supply for decades is a matter of course.

STAHL CraneSystems' SH ex, AS 7 ex and AS 7 ex ZW explosion-protected wire rope hoists in systematically modular design are available for the safe working load range from 1,000 kg to 100,000 kg. They are built for use in Zone 1 or Zone 21, however are also available for use in Zone 2 or Zone 22. The explosion-protected SHW ex winches are available for the heavy lifting range up to 160,000 kg. The ST ex chain hoist, one of the world's most comprehensive chain hoist programmes, is designed for the safe working load range from 125 kg to 6,300 kg. It is specifically designed for use in Zone 1 or Zone 21, however it is also available for use in Zone 22.

The facts

- International specialist for explosion-protected hoist and crane technology
- One of the widest comprehensive hoist product ranges in the world
- Our own production with certified quality assurance
- SH ex and AS 7 ex wire rope hoists for use in Zone 1, Zone 21, Zone 2 and Zone 22
- SHW ex winches for use in Zone 1, Zone 21, Zone 2 and Zone 22
- ST ex chain hoists for use in Zone 1, Zone 21 and Zone 22
- All designs certified to ATEX directives or IECEx regulations





3

- 1 A slewing crane equipped with an explosion-protected AS 7 ex wire rope hoist, S.W.L.: 5,200 kg
- 2 Single girder overhead travelling crane with an explosion-protected ST 20 ex chain hoist, S.W.L.: up to 1,600 kg. The travel drives for the underhung crane endcarriages are also explosion-protected.
- 3 Gantry crane with an explosion-protected SH 6 ex wire rope hoist, S.W.L.: 15,000 kg
- 4 LNG wire rope hoists on slewing cranes, Safety Level 2, engineering solution comprising two explosion-protected AS 7 ex wire rope hoists per crane, S.W.L.: 2,000/2,900 kg.
- 5 Single girder overhead travelling crane with two explosion-protected SH 40 ex wire rope hoists in tandem operation, S.W.L.: 3,200 kg each



4



5

Danger areas

A challenging industry is involved in natural gas liquefaction plants. Work with inflammable gas is hazardous. In an explosive atmosphere, both electrical and non-electrical components and elements in the lifting, drive and control technology can trigger an explosion. As a technological leader in explosion-protected crane technology, STAHL CraneSystems supplies hoist equipment suitable for all fields of LNG technology. The range extends from standard explosion-protected wire rope and chain hoists for routine maintenance work to the dual safety LNG wire rope hoists guaranteeing a maximum of safety. It is reassuring to know what convincing technology is concealed behind each hoist and each component. Everything is perfectly coordinated and thus provides unvarying high performance, long service life and high efficiency.

Motors



Motors for Zone 1 and Zone 21 are of grey cast iron, protection is a combination of flameproof enclosure »d«, increased safety »e« and protection by enclosure »tD«. For Zone 2 the motors are of aluminium and protection is non-sparking equipment »nA«. For Zone 22 the motors are in IP 66 and with protection by enclosure »tD«.

Panel box and control



The type of protection of panel boxes for Zone 1, Zone 2 and Zone 21 on crane and hoist combines flameproof enclosure »d«, increased safety »e« and protection by enclosure »tD«.

Overload protection



Overload protection for 1/1 reeving depends on the type of hoist and is provided by evaluation devices with field-proven analog or digital load measurement.

Cable entry

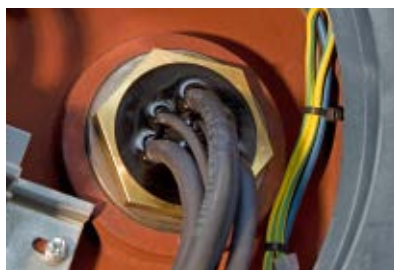

Indirect cable entry, extremely high safety level, provided by protection types increased safety »e« and flameproof enclosure »d«. Connection from the Ex e connection box to Ex d is by means of post-type bushings.

Off-standard rope drum



Off-standard rope drum for accommodating a work rope, with a recess for the fast action lock available as an option.

Rope lock



The client's off-standard ropes for pump maintenance are connected by rope locks. With the aid of the fast action lock, the hoist can easily be equipped with a bottom hook block to suit its application.

Control pendant



The SWH 5 ex control pendants are specifically designed for controlling hoists and cranes in hazardous areas. The two-step control pendant SWH ex in protection type IP 66 is used on explosion-protected wire rope hoists for Zone 1.

Signal transmitters



Visual and acoustic signal transmitters such as horns and flashing lights meet ATEX directives and IECEx regulations. They can be used in Zone 1, Zone 2, Zone 21 and Zone 22. The signal transmitters can be activated by a button in the control pendant.

Wheels



The protection type of all wheels is constructional safety »c«. Among other measures, wheels are made of brass for high travel speeds.

In action across the world

Experts in all countries immediately recognise hoists and crane components of the STAHL CraneSystems brand. Our systematically engineered and highly developed solutions are in use everywhere. STAHL CraneSystems ranks among world market leaders for explosion-protected crane technology. With the world's widest product portfolio, we know what is important and always find the ideal solution combined with maximum cost-effectiveness. The off-standard LNG hoists and the explosion-protected hoist and crane technology programme as a whole meet European ATEX directives or the international IECEx regulations. STAHL CraneSystems is represented on all continents by subsidiaries, sales and crane building partners.



The Netherlands
Rotterdam ●

The Netherlands

At the GATE terminal (Gas Access To Europe) in Rotterdam, Netherlands, there are three LNG tanks with a total volume of 540,000m³. Each tank is equipped with LNG hoist technology from STAHL CraneSystems in Safety Level 3A. The hoists, each equipped with two separately driven rope drums and with 2,400kg S.W.L., are used for maintenance work on the tanks' liquefied gas pumps. The custom-built hoists are protected from the severe environmental conditions such as wind and rain by a housing with maintenance bridges on both sides. Supplementing the maintenance crane, there is a further slewing crane equipped with an explosion-protected SH 30 ex wire rope hoist on each of the liquefied gas tanks. These slewing cranes transport tools and small components up to the tank's platform.



China

STAHL CraneSystems has been producing custom-built hoists for LNG plants and gas tanks in all safety levels since 1997. Our subsidiary in Shanghai, China, has from 2006 up to the present processed orders for twelve LNG terminals in China, comprising both standard explosion-protected hoists and custom-built LNG hoists. The current project in North China involves LNG wire rope hoists in Safety Level 1. The hoists are based on the SH 60 ex wire rope hoist and are mounted on slewing cranes on the liquefied gas tanks. They have a safe working load of 3,500 kg and a lifting height of 58 metres. The wire rope hoists were adapted to meet Chinese specifications for use on the LNG tanks by modifying the controls and the rope drums. The saline air and the harsh coastal climate made special corrosion-resistant paint necessary. A housing protects the hoists from adverse weather conditions during shutdowns, which may often last several months. The maintenance bridges on both sides provide better access to the hoists when changing the ropes and for maintenance.



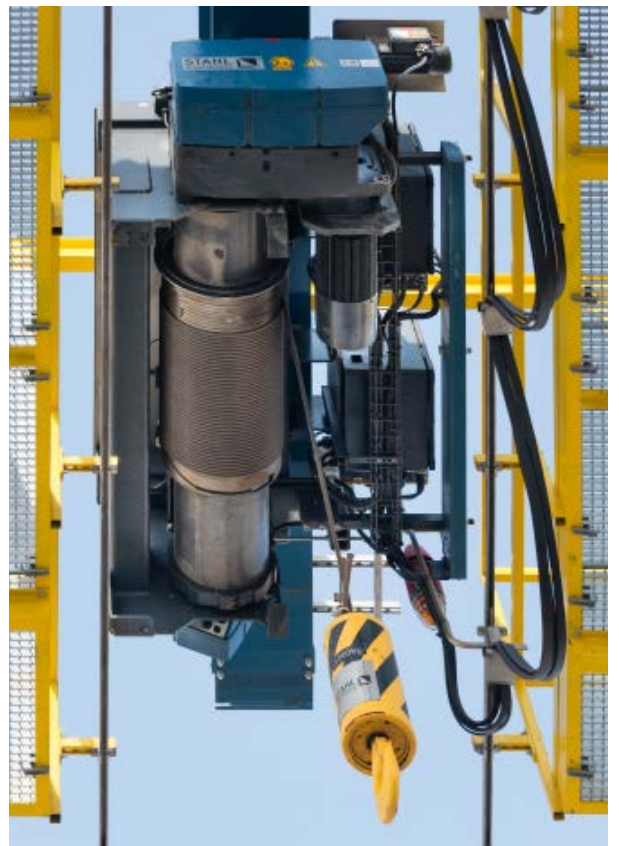

Australia

The Ichthys LNG project, one of the most significant oil and gas projects and one of the largest offshore plants in the world, is at present under construction approximately 220km off the coast of Western Australia. It combines three major projects in one, the offshore Central Processing Facility (CPF), the Floating Production, Storage and Offloading Facility (FPSO tanker) and onshore facilities with LNG trains. All crane systems must meet the numerous requirements and specifications demanded by the contractors, the countries involved and the responsible test authorities. Top quality project implementation, specific material requirements and material certifications and detailed testing of the equipment to

be used in hazardous and non-hazardous areas were stipulated, in addition to strict specifications from the marine classification company DNV, including design testing and certification and a certified overload test with 125% of the maximum working load. One of STAHL CraneSystems' specialised Australian crane building partners rose to this challenge. A total of six cranes, custom-built for ambient temperatures up to +45°C, is to be erected in the offshore plant, three of them explosion-protected. The cranes are also equipped with space heaters so that they are always available even at low temperatures. One of the maintenance cranes is a spectacular custom-built solution for lifting the thruster of the FPSO tanker. This double girder overhead travelling crane has an S.W.L. of 70,000 kg and is equipped with two SHWF 8 winches, each with 50,000 kg S.W.L. Two SH wire rope hoists, each with 5,000 kg S.W.L., act as fast auxiliary hoists. The two SHWF 8 winches are in fully redundant design. They are equipped with off-standard centrifugal brakes with brake release and integrated automatic coupling, with which the load can be safely lowered even during a power cut. Both long and cross travel drives are rack-and-pinion, enabling them to be used even in rough seas. All the hoists are equipped for offshore use and possible contact with seawater.

Australia

Perth





Russia

At present one of the most ambitious LNG plants ever built is rising on the Jamal peninsula in Russia and is scheduled for commissioning in 2017. The explosion-protected crane systems and LNG hoists operate in partially open, unheated buildings and are constantly exposed to temperatures well below 0°C. Material durability, compliance with strict explosion protection directives and constant operational availability must be guaranteed even in these extreme conditions. All the cranes' hoist and trolley components are therefore enclosed in housings and equipped with heaters and individual safety circuits. The temperature inside the housing can be maintained at above -20°C. The crane control evaluates several temperature sensors before permitting the crane to be put into operation. Crane bridges, crab beams, endcarriages and crabs are manufactured from P355 NL1, a special low-temperature steel. STAHL CraneSystems is supplying the explosion-protected customised hoists for maintenance cranes. The explosion-protected AS 7 ex ZW twin hoist with an S.W.L. of 100,000 kg is used for the maintenance of the heavy gas compressors. For lighter loads and faster hoisting speeds, each of the cranes is equipped with an auxiliary hoist from the SH ex series of wire rope hoists, also mounted on the large crab inside the heated housing.



Argentina Australia Austria Belgium Brazil Canada Chile **China** Columbia Croatia Czech Republic
Denmark Ecuador Egypt Estonia Finland **France** Germany **Great Britain** Greece Hongkong Hungary **India** Indonesia

Ireland Israel Italy Jordan Latvia Lebanon Lithuania Malaysia Mexico
Netherlands Nigeria Norway Pakistan Peru Philippines Poland **Portugal** Rumania Russia

Singapore Slovakia Slovenia South Africa South Korea **Spain** Sweden Syria
Taiwan Thailand Turkey **UAE** Uruguay **USA** Venezuela Vietnam

Sales partners **Subsidiaries**

Please order our other brochures

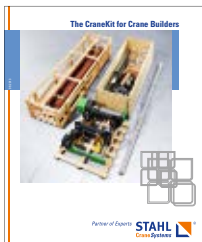
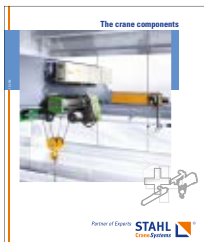
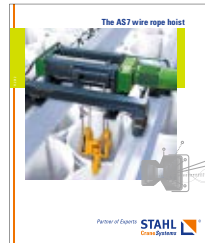

Presented by

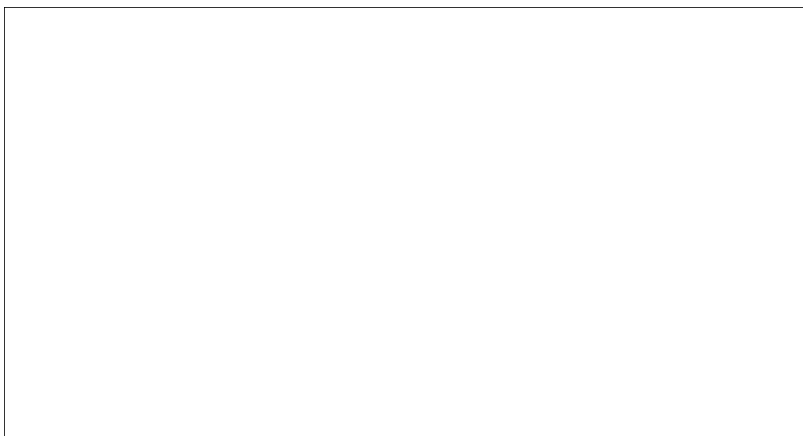

→ www.stahlcranes.com

STAHL CraneSystems GmbH
Daimlerstr. 6, 74653 Künzelsau, Germany
Tel +49 7940 128-0, Fax +49 7940 55665
marketing.scs@stahlcranes.com

Partner of Experts



All specifications and illustrations are non-binding.
Subject to modification, errors and printing errors excepted.
Printed in Germany. Sach-Nr. 990 070 0 F-PB-10-EN-10.15-vis visuell.de